



# 中国家电及消费电子博览会

APPLIANCE & ELECTRONICS WORLD EXPO

## AWE2023

### 会刊

CATALOGUE

2023.4.27-30

中国·上海 新国际博览中心

科技  
创未来  
SMARTIZE  
THE FUTURE



更多信息扫码关注

Haier | AWE

海尔智家

# 数智共生 万象更新

Transformative Power of Data Intelligence

海尔智家2023 AWE 智慧生活展

上海新国际博览中心N5馆 | 4.27 - 4.30

Hisense



## Go Tech, and Beyond

科技之上 / 享品质人生

W5馆 5F01 5F11 5F31 5F51 5F71



# AWE2023 Visitor Services

## AWE2023观众服务



<b>主办服务处</b> Service Center	<b>观众登录处</b> Registration and Entrance/Exit	<b>咨询台</b> Information Desk	<b>主运输</b> Logistics and Shipping	<b>主搭建</b> Construction
<b>新闻中心</b> (E1馆M16会议室) Media Center (M16, E1)	<b>医疗室</b> (W2 B2会议室) Medical Care Room	<b>摆渡车站</b> Shuttle Bus Station	<b>地铁班车</b> Shuttle Bus Pick-up Location At Metro Station	
<b>VIP休息室</b> VIP Rest Area	<b>喜玛拉雅酒店</b> Jumeirah Himalayas Hotel Shanghai	<b>嘉里酒店</b> Kerry Hotel, Pudong, Shanghai	<b>派出所</b> Police Station	

# AWE2023同期论坛及活动

## Concurrent forums and activities

活动名称 Activity	组织方 Organizer	时间及地点 Time & Place
<b>2023年中国家电产业链大会</b> China Household Electrical Appliance Industry Chain Conference 2023	主办:《电器》杂志社 Organizer: China Appliance magazine	4月26日 9:00-11:30 上海皇廷世际酒店 宴会厅 9:00-11:30 April 26 Royal Banquet Hall, Royal Century Hotel Shanghai
<b>2023 中国家电创新零售峰会</b> China New Retail Conference 2023	指导单位: 中国家用电器协会 主办单位: 国家电网 特约联合主办: GfK 中国 Supervisor: CHEAA Organizer: CHEAA.com Co-organizer: GfK China	4月26日 9:30-16:30 上海东方万国会议中心 宴会厅 9:30-16:30 April 26 Grand Ballroom, The Oriental Conference Center, Shanghai
<b>2023AWE 高峰论坛</b> ——创新无界 向实而生 AWE Summit 2023-Innovation for Real Change	主办: 中国家用电器协会 Organizer: CHEAA	4月27日 14:00-16:30 喜玛拉雅酒店 三楼大宴会厅 14:00-16:30 April 27 Grand Ballroom, 3rd Floor, Jumeirah Himalayas Hotel, Shanghai
<b>2023AWE 高峰论坛</b> ——未来家2035 AWE Summit 2023-Future Home 2035	主办: 中国家用电器协会 Organizer: CHEAA	4月28日 9:00-11:30 喜玛拉雅酒店 三楼大宴会厅 9:00-11:30 April 28 Grand Ballroom, 3rd Floor, Jumeirah Himalayas Hotel, Shanghai
<b>GTIC2023全球AIoT 智能家居峰会</b> GTIC 2023   Global Technology Innovation Conference on AIoT and Smart Home	主办: AWE、智东西 Organizer: AWE, Zhidx.com	4月28日 14:00-17:30 喜玛拉雅酒店 三楼大宴会厅 14:00-17:30 April 28 Grand Ballroom, 3rd Floor, Jumeirah Himalayas Hotel, Shanghai
<b>2023 中国清洁电器高峰论坛</b> China Vacuum Cleaning Appliance Forum 2023	主办:《电器》杂志社 指导单位: 中国家用电器协会 Organizer: China Appliance magazine Supervisor: CHEAA	4月28日 14:00-17:30 嘉里酒店 浦东厅 1-3 14:00-17:30 April 28 Pudong Ballroom 1-3, Kerry Hotel, Pudong, Shanghai
<b>AWE 艾普兰奖颁奖典礼</b> AWE Award Ceremony	主办: AWE 组委会 Organizer: AWE Organizing Committee	4月29日 10:00-12:00 喜玛拉雅酒店 三楼大宴会厅 10:00-12:00 April 29 Grand Ballroom, 3rd Floor, Jumeirah Hotel, Himalayas Shanghai
<b>空调器绿色低碳制冷技术成果展示暨技术路演</b> Show and Release of Green and Low-carbon Refrigeration Technologies in Room Air Conditioner Sector	主办: 生态环境部对外合作与交流中心 联合国工业发展组织 联合国环境署 中国家用电器协会 Organizer: FECOM/EE, UNIDO, UNEP, CHEAA	4月28日 9:30-11:30 W3馆3E100 April 28 9:30-11:30 3E100, W3

# 敢 为 不 凡 INSPIRE GREATNESS



扫码购买AWE同款产品



- 8 AWE2023 欢迎辞  
Welcome to AWE2023
- 12 中国家用电器协会简介  
China Household Electrical Appliances Association
- 95 参展商名录 (按展馆排序)  
Hall Overview
- 157 参展商名录 (按字母排序)  
Alphabetical List of Exhibitors



## AWE2023 欢迎辞

在春暖花开的季节，我们再次相聚在上海，共同见证家电及消费电子行业的年度盛会隆重召开。在此，我谨代表主办方——中国家用电器协会，向关心和支持AWE的所有参展企业、渠道商、行业同仁、新闻媒体、热心观众以及合作伙伴们，表示热烈的欢迎和衷心的感谢！

过去3年，新冠疫情给我们的生活及AWE带来前所未有的影响和挑战。由于上海疫情，去年的AWE在即将开幕时不得不按下“暂停键”。今天，疫情消退，我们终于迎来了2023AWE的开幕时刻，迎来了第十一届AWE。在这里，我要特别感谢各级领导，以及克服种种困难一直支持我们的所有参展企业和合作伙伴们，感谢你们的信任、坚持和努力。我坚信，2023AWE依然会用它的精彩回馈大家！

2023AWE展示面积超过15万平方米，覆盖13个展馆，超过1000家的中外企业将在这里璀璨亮相，为消费者带来最先进的智能生活解决方案和最高科技含量、最新的家电及消费电子产品与技术。

今年展会主题是“智科技，创未来”，聚焦“智慧场景”、“智能科技”、“创新技术”等，呈现新一代信息技术与家电消费电子行业深度融合的最新成果。呈现智能、绿色、健康、集成、套系、潮流等产品趋势，很好地契合了后疫情时代消费者关注健康、注重安全、智能生活、绿色低碳、时尚潮流的需求，展现了行业重视创新、勇于突破的新面貌。在AWE，产业边界不断被打破，呈现横跨家用电器、消费电子、智能家居、智慧娱乐、智能出行等诸多领域的融合科技生态。

展会期间将有百余场发布会，一大批中外企业将自己年度最新锐产品在这里集中首发和亮相，让观众可第一时间感受到重量级年度新品和新技术的魅力。AWE不仅是展示家电和消费电子行业最新创新成果和年度新品首发的超级秀场，也是未来智慧生活的样板间和体验馆，今年的AWE展示了为众多的创新产品和智能场景解决方案，这些创新不仅为消费者擘画了未来智慧生活的美好图景，也将引领和推动行业产品创新的方向。

中国是推动全球家电和消费电子领域增长的主要引擎，作为全球三大家电与消费电子展之一，AWE承载行业创新成果展示与创新加速器功能。重启后的AWE，将通过全球视野及影响力的平台优势，展示前沿科技在产业落地的最新成果，持续引导家电及消费电子技术发展方向和消费趋势。我们将努力打造科技型、创新型、数字化的AWE，让AWE成为一年一度的全球家电及消费领域科技盛会。

我们希望，与全球伙伴携手合作，进一步突出创新驱动和科技引领作用，为行业高质量发展助力，为消费者的幸福生活助力！

最后，预祝本届AWE取得圆满成功！谢谢大家！

中国家用电器协会执行理事长



## Welcome to AWE2023

In this beautiful spring, we gather once again to witness the opening of this grand event of home appliance and consumer electronics industry. On behalf of the organizer China Household Electrical Appliances Association (CHEAA), I would like to extend my warm welcome and sincere thanks to all the exhibitors, distributors, industry colleagues, media, attendees and partners for your long-term support.

The outbreak of COVID-19 took a toll on our daily life in the past three years. Last year, AWE screamed to a halt right before the opening due to the sudden outbreak of COVID-19 in Shanghai. But with the optimization of COVID-19 prevention and control measures carried out, we finally come to this moment, the opening of the 11th AWE-AWE2023. I would like to extend my special thanks to leaders at all levels as well as our exhibitors and partners who stood by us in all the difficulties for your trust, perseverance and endeavor. I am confident that AWE2023 will be splendid with all our efforts as well as yours.

AWE2023 brings together more than 1000 exhibitors from home and abroad in 13 halls on an area of 150,000 square meters to offer consumers cutting-edge smart life solutions and high-tech home appliances, consumer electronics and technologies.

Under the theme of "Smartize the Future", AWE2023 highlights smart scenarios, intelligent technologies and innovative technologies to showcase the latest innovations that integrate home appliances and consumer electronics with next generation information technologies and display industry trends towards smart, green, health-oriented, integrated, packaged and stylish products, which reflects consumers' concerns for health, security, smart life, green and low carbon, and style in the post-pandemic era and the industry's endeavor to make innovations and breakthroughs. At AWE, tech-powered ecosystems that cross fields including home appliances, consumer electronics, smart home, smart entertainment and smart travel are displayed.

With more than a hundred releases launched by enterprises to unveil their new blockbusters of the year, attendees can fully immerse themselves in new products and technologies right after the releases. AWE is a catwalk for new innovations and product releases as well as an experience center for future smart home. This year, AWE will display numerous innovative products and smart scenario solutions, which draws a blueprint of future smart life for consumers and signals the new directions of product innovation of the industry.

As a strong growth engine of global home appliance and consumer electronics industry and a top three global show of the field, AWE displays and accelerates industry innovation. The comeback of AWE will use its advantage as a platform with global vision and influence to showcase the applications of advanced technologies in the industry while guide the technical and consumption trend of the industry. We aim to establish AWE into a high-tech, innovative and digital show and make it an annual tech gala of global home appliance and consumer electronics.

We hope to highlight the importance of innovation and technology, advance the high-quality development of the industry and contribute to the happiness of consumers' daily life along with our global partners. Finally, I wish AWE2023 a great success. Thank you!

Executive President of China Household Electrical Appliances Association





## 中国家用电器协会介绍

中国家用电器协会（英文名称 CHINA HOUSEHOLD ELECTRICAL APPLIANCE ASSOCIATION，简称 CHEAA）成立于 1988 年 12 月，是由在中国登记注册的家用电器行业的制造商企业、零配件和原材料配套企业等自愿组成的行业性、全国性、非营利性社会组织，是社会团体法人。受业务主管部门国务院国有资产管理委员会、中国轻工业联合会和社团登记管理机关民政部的业务指导和监督管理。

宗旨：代表本行业企业的利益，维护行业合法权益，反映会员企业诉求，协调会员之间关系，规范会员行为，维护公平竞争与市场秩序，联系政府，为行业、会员、政府提供服务，促进行业的健康发展。

协会的基本职能为，维权、服务、自律、协调和监督，协助政府实施行业管理。具体职能如下：

- (一) 参与政府有关经济政策、产业政策的研究，提出有利于行业发展的政策和立法建议；组织开展行业发展、战略规划等重大问题的研究；
- (二) 向政府部门反映行业、会员诉求，维护会员合法权益；
- (三) 开展行业数据统计调查，收集、分析、发布行业信息，为会员、政府和社会各界提供咨询服务；
- (四) 组织和参与制订、修订国家标准或行业的技术标准、服务标准和行业准入标准，开展协会标准的制订工作；
- (五) 健全行业自律管理制度，规范会员企业之间的竞争行为，协调会员关系，维护公平竞争的市场秩序；
- (六) 促进品牌建设，推进产品质量的提高，配合政府部门对本行业的产品质量进行管理；
- (七) 组织开展新技术的交流与推广，组织新产品鉴定和推广，推动新技术在本行业中的推广和应用，推进技术创新和科学管理，提高行业技术水平和国际竞争力；
- (八) 组织和推动行业开展节能减排工作，开展绿色设计、废家电产品资源回收和再利用，促进家电产品的节能水平不断提高；
- (九) 促进国内、国际贸易活动开展，促进消费知识的普及，组织国内外展览、展销活动，维护企业在贸易活动中的合法权益，参与协调国际贸易争端；

- (十) 组织开展本行业人才、技术、职业、管理、政策法规等培训，指导、协助会员企业改善经营管理；
- (十一) 积极发展与国外相关协会、国际组织的联系与合作，组织行业参加有关国际交流活动；
- (十二) 宣传行业，创办协会出版物和行业网站；
- (十三) 发展公益事业，承担社会责任；
- (十四) 承担政府委托的职能和工作；
- (十五) 开展有益于会员企业及国家法律法规所允许的其他活动。

联系方式：

地址：北京市崇文区广渠门内大街 80 号通正国际大厦 709 室

邮政编码：100062

电话：010-51696622

传真：010-51696621

网址：[www.cheaa.org](http://www.cheaa.org)



中国家用电器协会  
官方微信公众号



## Introduction of CHEAA

China Household Electrical Appliances Association (CHEAA) was established in December 1988. CHEAA is registered by the Chinese manufacturer of household appliances industry, business, spare parts and raw materials, auxiliary enterprises, research institutions and other voluntary agencies. CHEAA is a self-composed, non-profit social and economic organization, is a legal person in non-government organization. By the competent departments of the Association of State-owned Assets Management Committee, China Light Industry Federation and the Ministry of Civil Affairs community registration authority guidance and supervision and management.

Complying with the Chinese Constitution, laws and regulations, CHEAA's main objective is to represent and defend the Chinese Industry interests, to defend legal rights of its members, and to promote a fair and orderly competitive market environment. By this means, the association hopes to serve its members, the appliance industry and the government, and to contribute to the healthy and sustainable development of the industry. CHEAA's functions includes safeguarding the rights, services, self-discipline, coordination and supervision, assists the government in the implementation of industrial management.

### Specific functions are as follows:

- (1) Participate in government economic policy, industrial policy research favorable to industry policy and legislative proposals; organizes in industry development, strategic planning and other major issues;
- (2) Reflect the industry to government departments, membership aspirations, safeguard the legitimate rights and interests of members;
- (3) To carry out the survey industry data collection, analysis, publishing industry information, to provide members, government and community with advisory services;
- (4) To organize and participate in the formulation, revision of national standards or industry technical standards, service standards and industry access standards, standard-setting association to carry out the work;
- (5) Help making a sound management system of industry self-regulation, regulate competition between member companies, coordination of Member relations and safeguarding the market order of fair competition;
- (6) Promote the brand construction, promote the improvement of product quality, with the government departments of the industry's product quality management;
- (7) Organize the exchange and promotion of new technologies, organizational identification and promotion of new products, promote new technologies in the industry in the promotion and application, promote technological innovation and scientific management, improve technical level of industry and international competitiveness;

- (8) Organize and promote energy conservation and emission reduction industry, carry out green design, waste home appliances recycling and reuse of resources, and promote energy-efficient home appliances has improved continuously;
- (9) To promote domestic and international trade activities undertaken to promote the popularity of consumer knowledge, organizations domestic and international exhibitions, marketing activities, maintenance of enterprises in the trade activities of the legitimate rights and interests involved in the coordination of international trade disputes;
- (10) Organize the industry professionals, technical, vocational, management, policies and regulations, such as training, guidance, and help member companies improve their business management;
- (11) Positive development with foreign associations, international organizations and cooperation, organizing the industry to participate in the international exchange activities;
- (12) Promote the industry, the founder of Association publications and industry websites;
- (13) The development of public welfare, social responsibility;
- (14) Assumes the functions and work commissioned by the Government;
- (15) To carry out other activities beneficial to member companies and state laws and regulations allowed.

### Contact us

Address: Room 709, Talent International Building, No.80 Guang Qumen Inner Avenue Beijing P.R.C.  
Postal Code: 100062  
Tel:86-10-51696622  
Fax:86-10-51696621  
Website: [www.cheaa.org](http://www.cheaa.org)



# E1 清洁电器、生活电器馆

Cleaning Appliances, Living Appliances

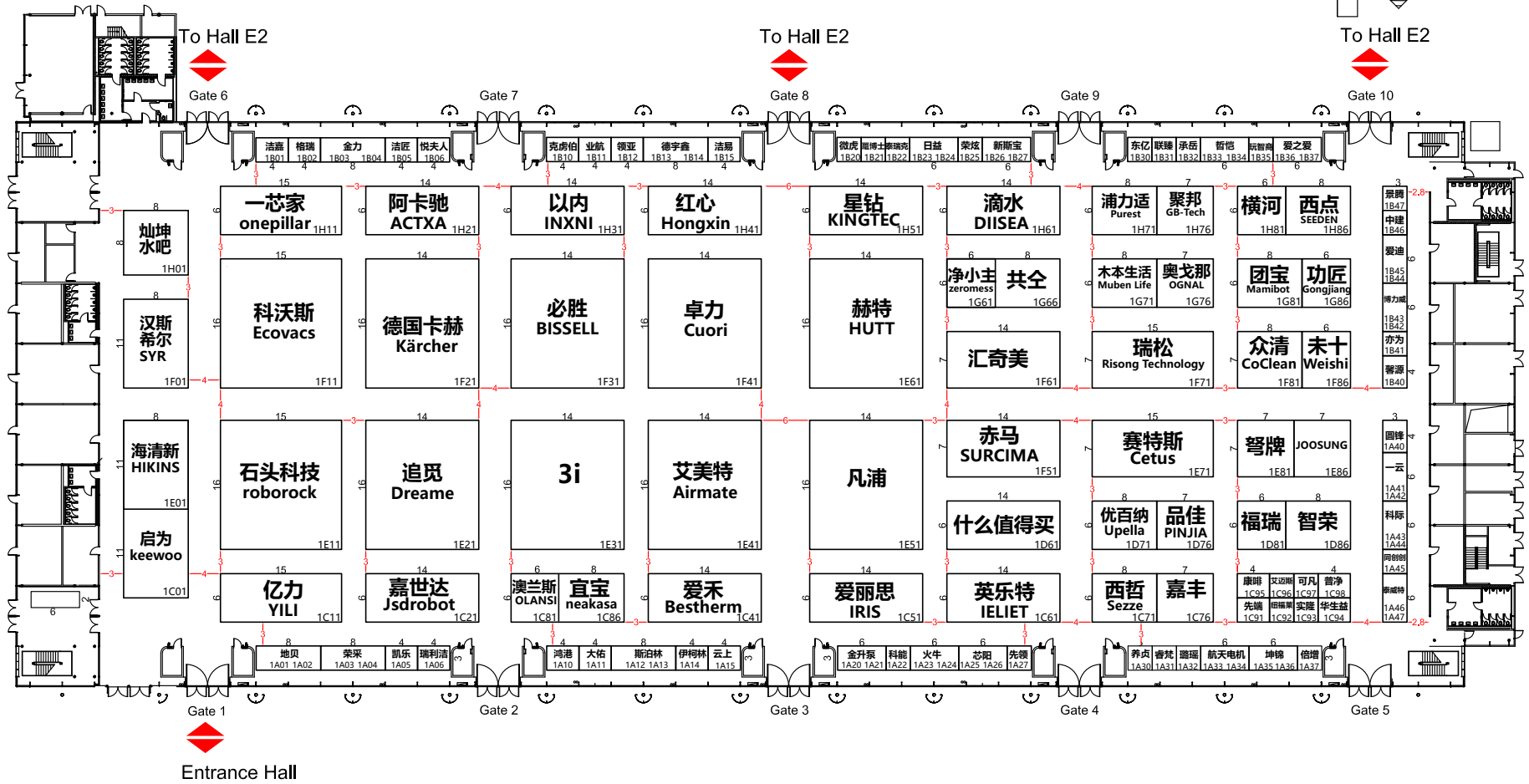
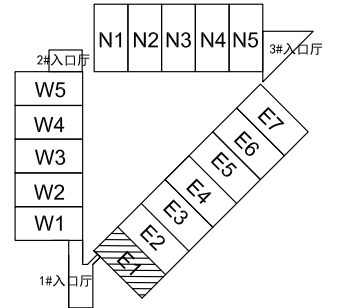



# E2 健康电器、厨房小家电馆

Health Appliances, Kitchen Small Appliances

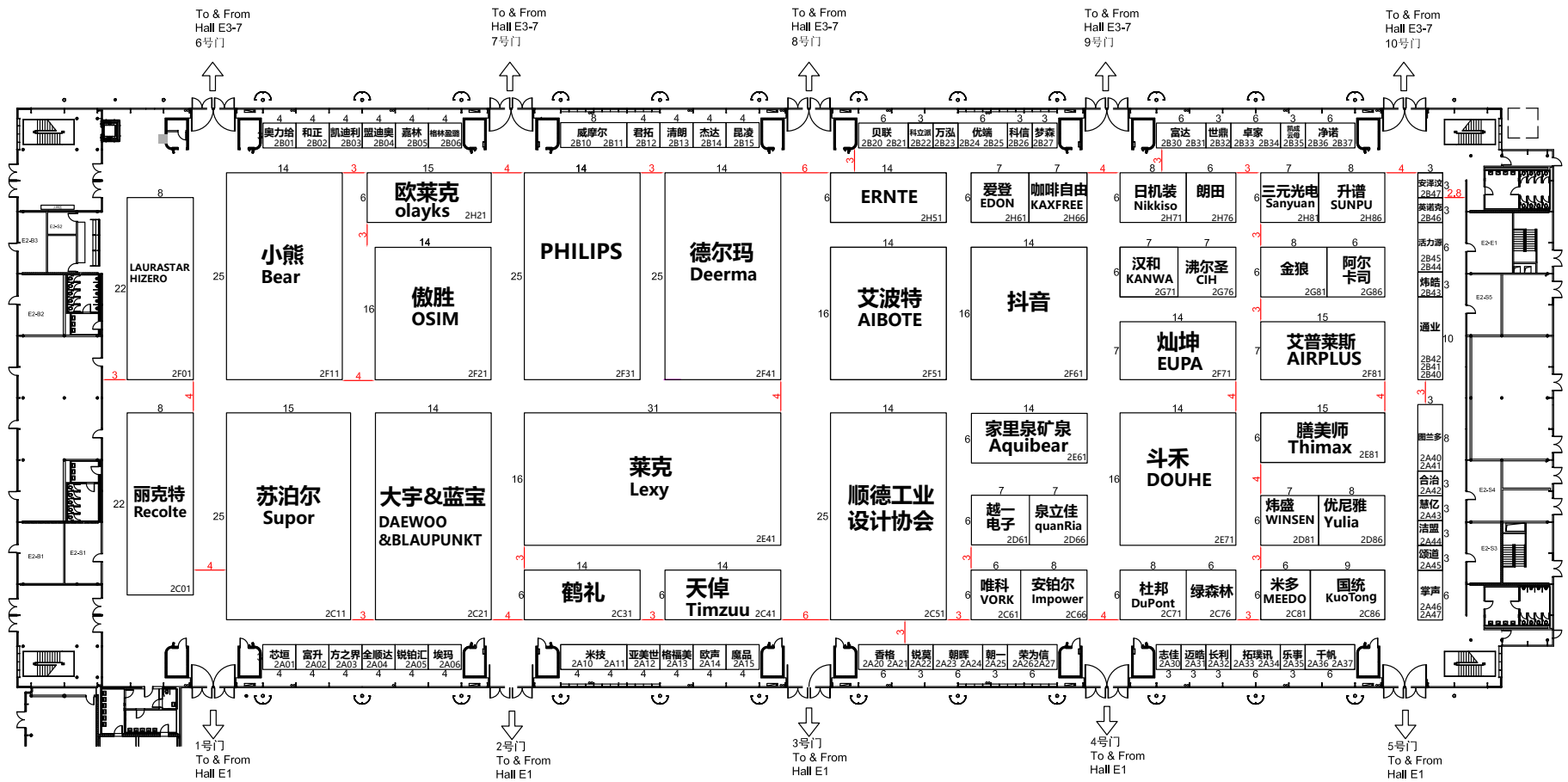
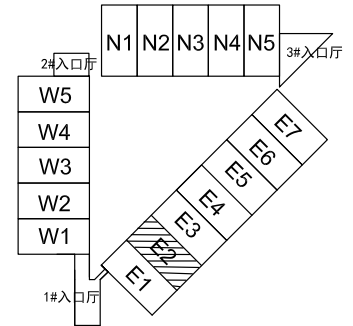





# E3 美健电器馆

Beauty and Health Appliances

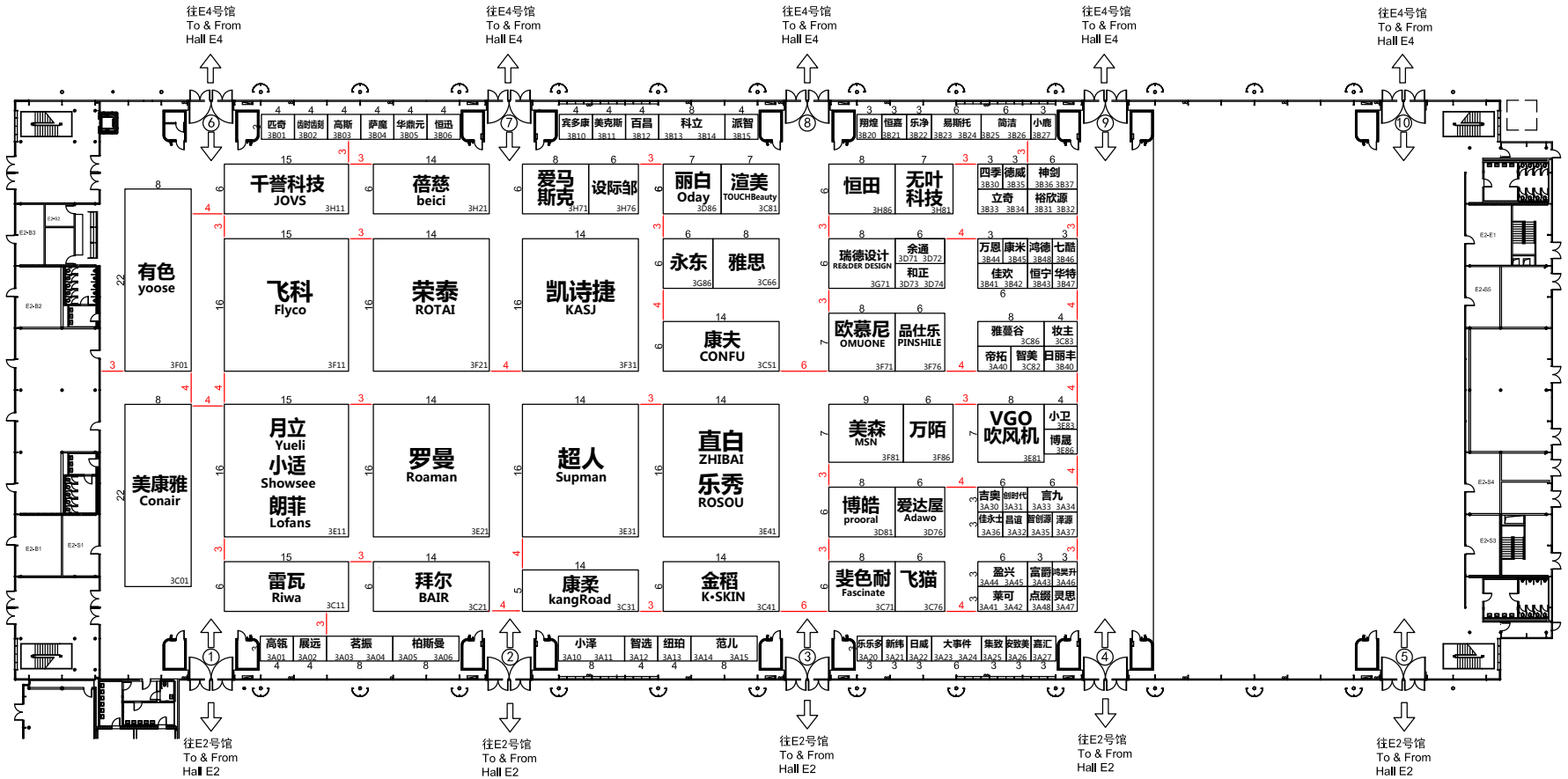
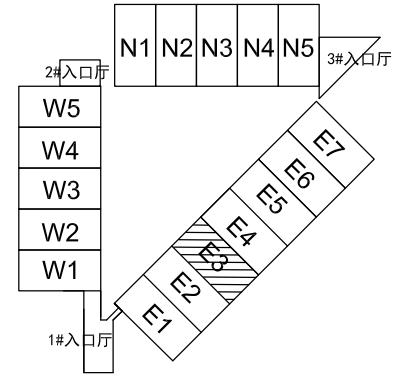



AWE 2023

# N1 智能厨卫馆

Smart Kitchen and Bathroom

内广场

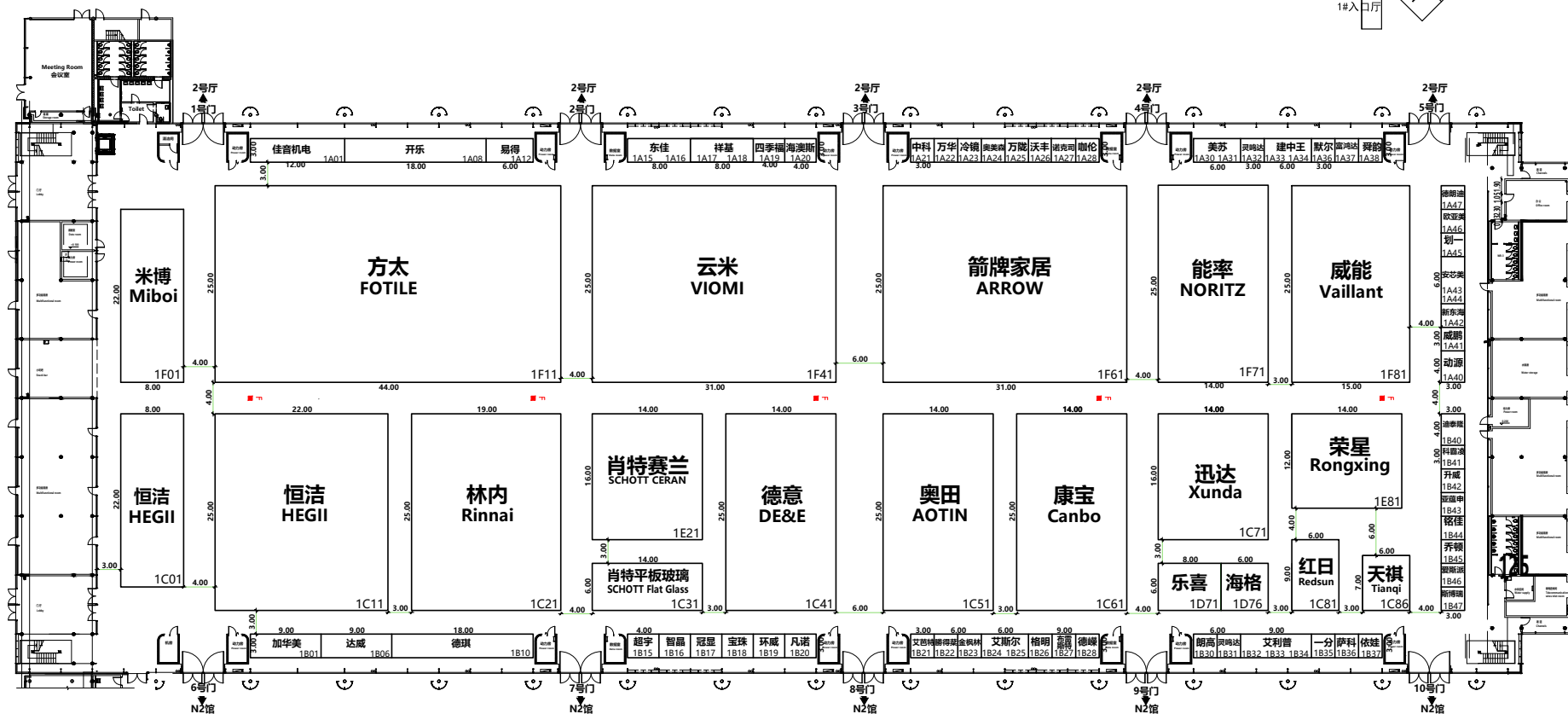
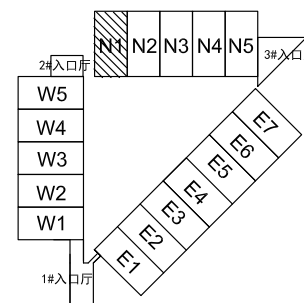



**AWE 2023** **N2** 智能厨电馆  
Smart Kitchen

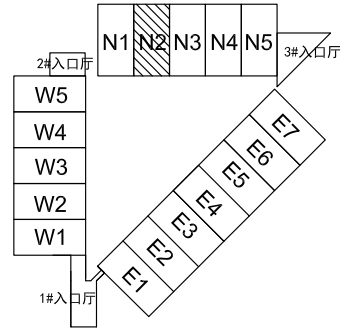

内广场  
←

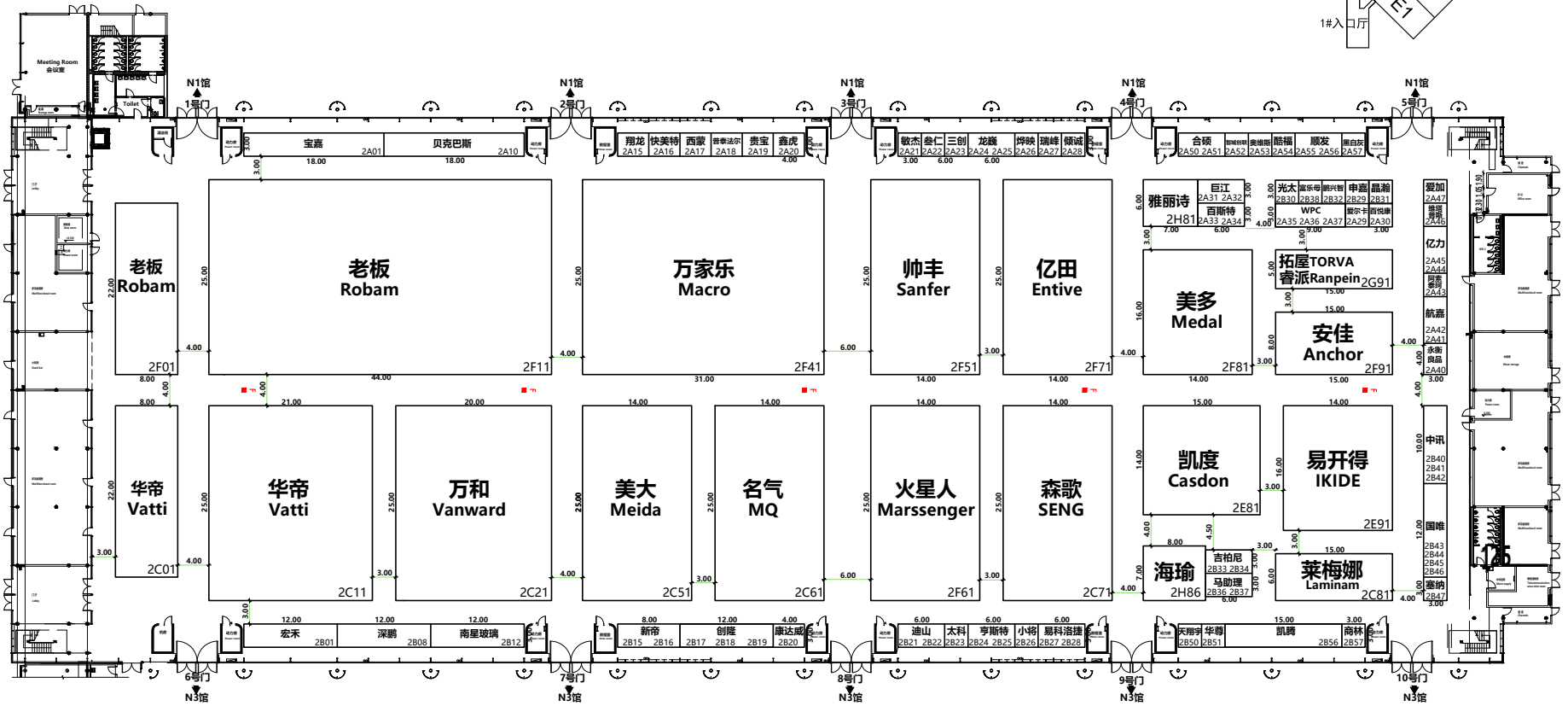



# AWE 2023 N3 智能厨电 厨房小家电馆

Smart Kitchen Appliances, Kitchen Small Appliances

内广场

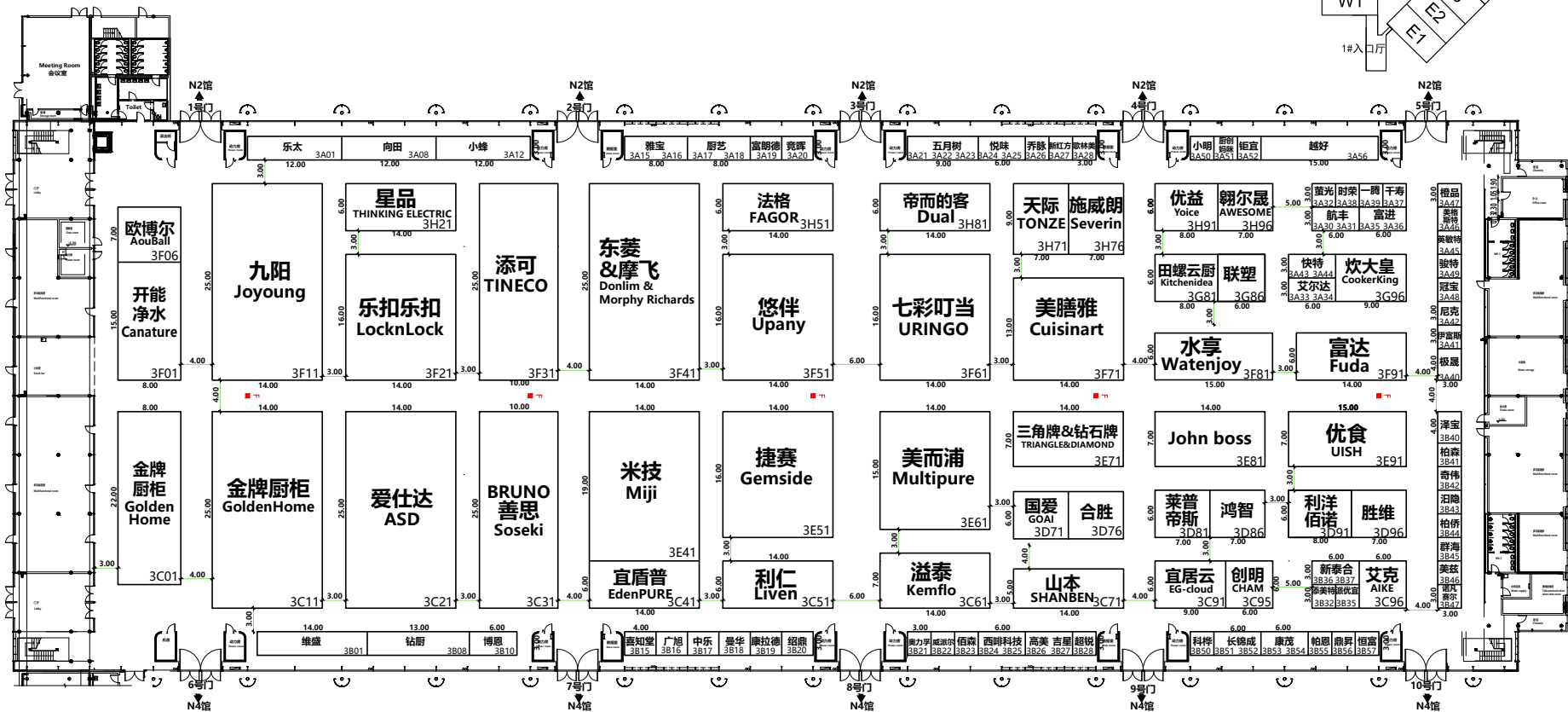
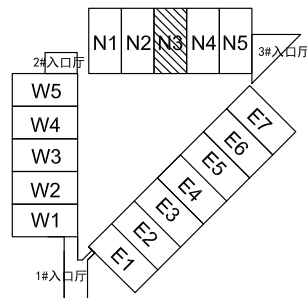





# N4 国际品牌馆

International Brand

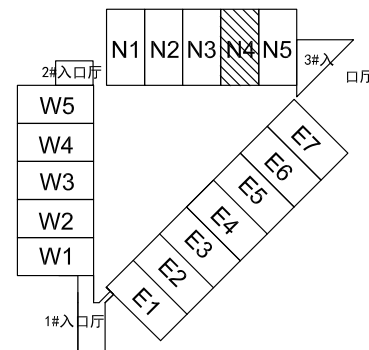

内广场

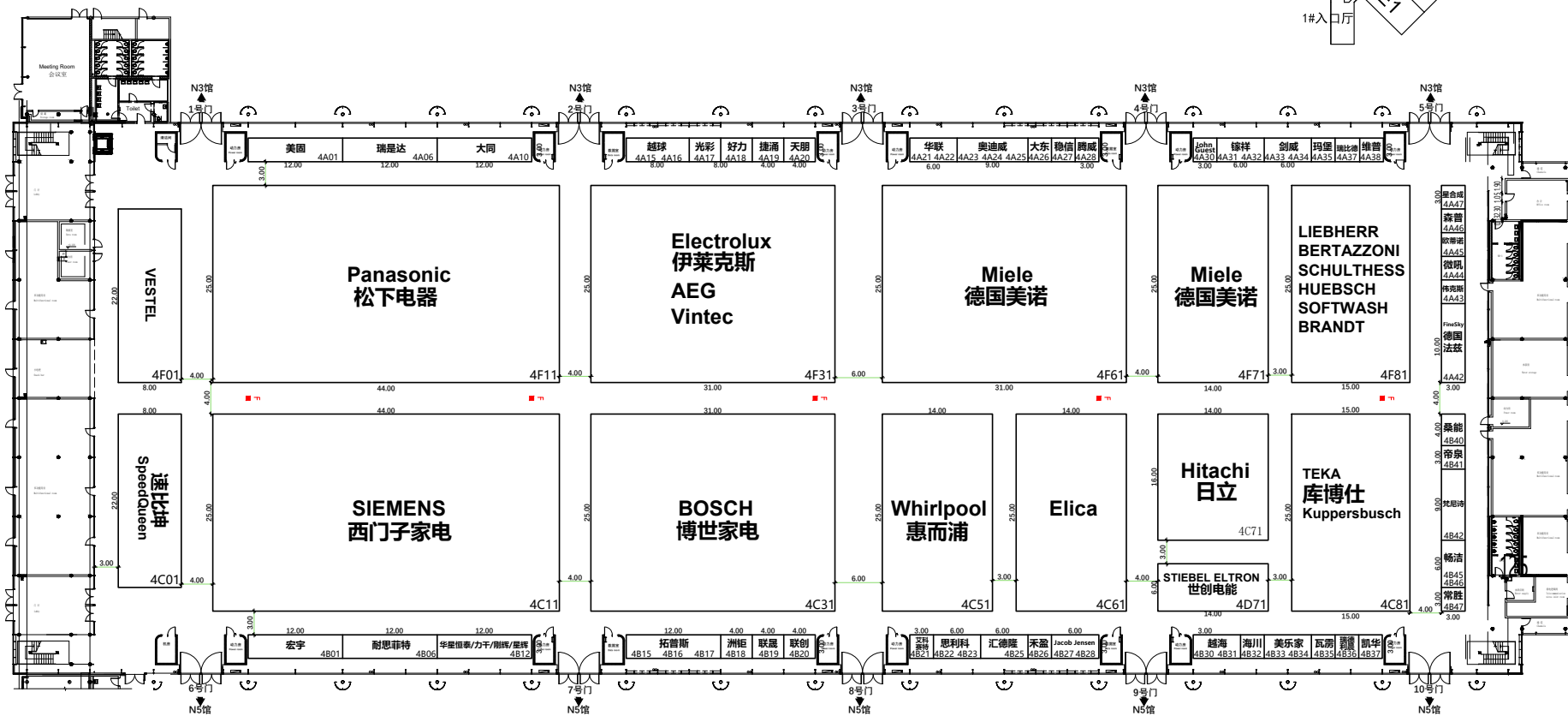



AWE 2023

# N5 海尔智家馆

Haier Smart Home Hall

内广场  
←

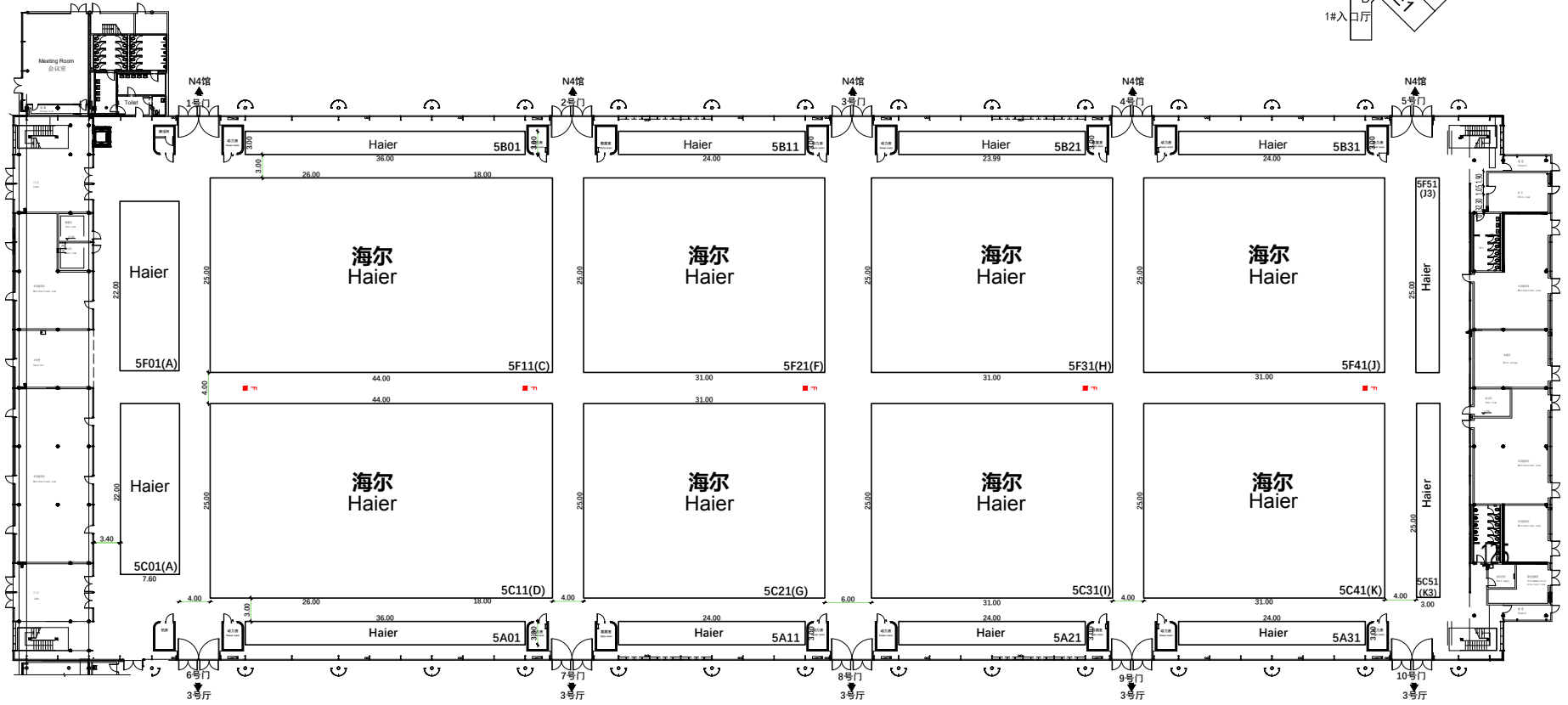
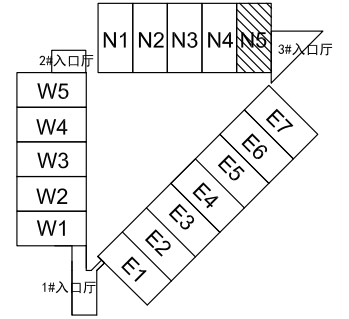



# W1 智能家电馆

Smart Appliances

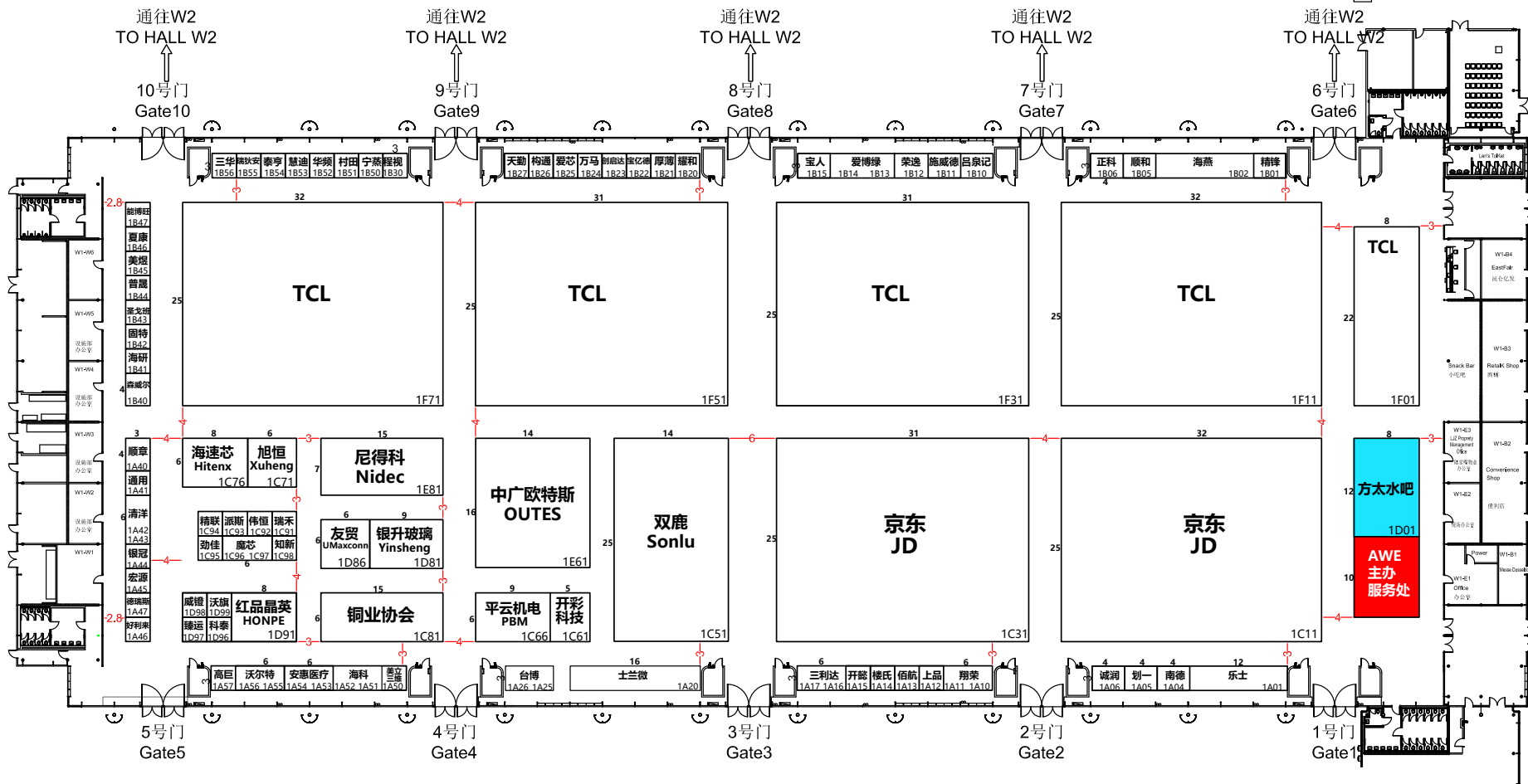
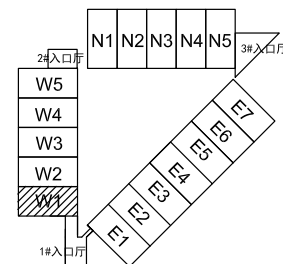



# W2 智能家电及环境电器馆

## Smart Appliances & Environmental Appliances

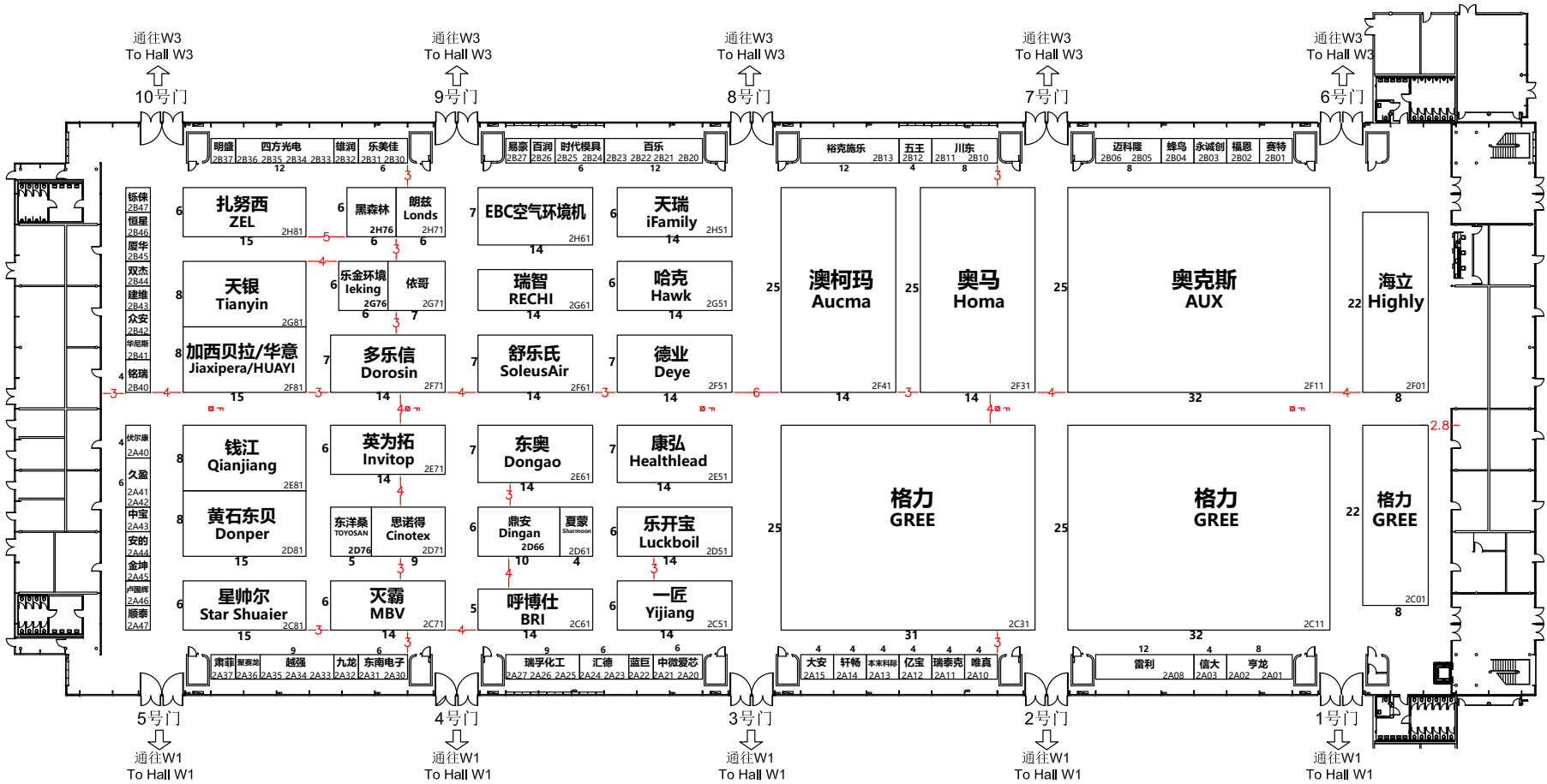
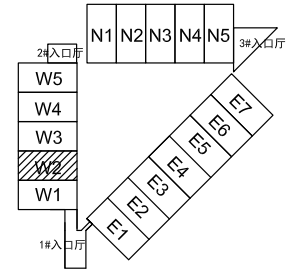





# W3 智能科技馆

Smart Technology

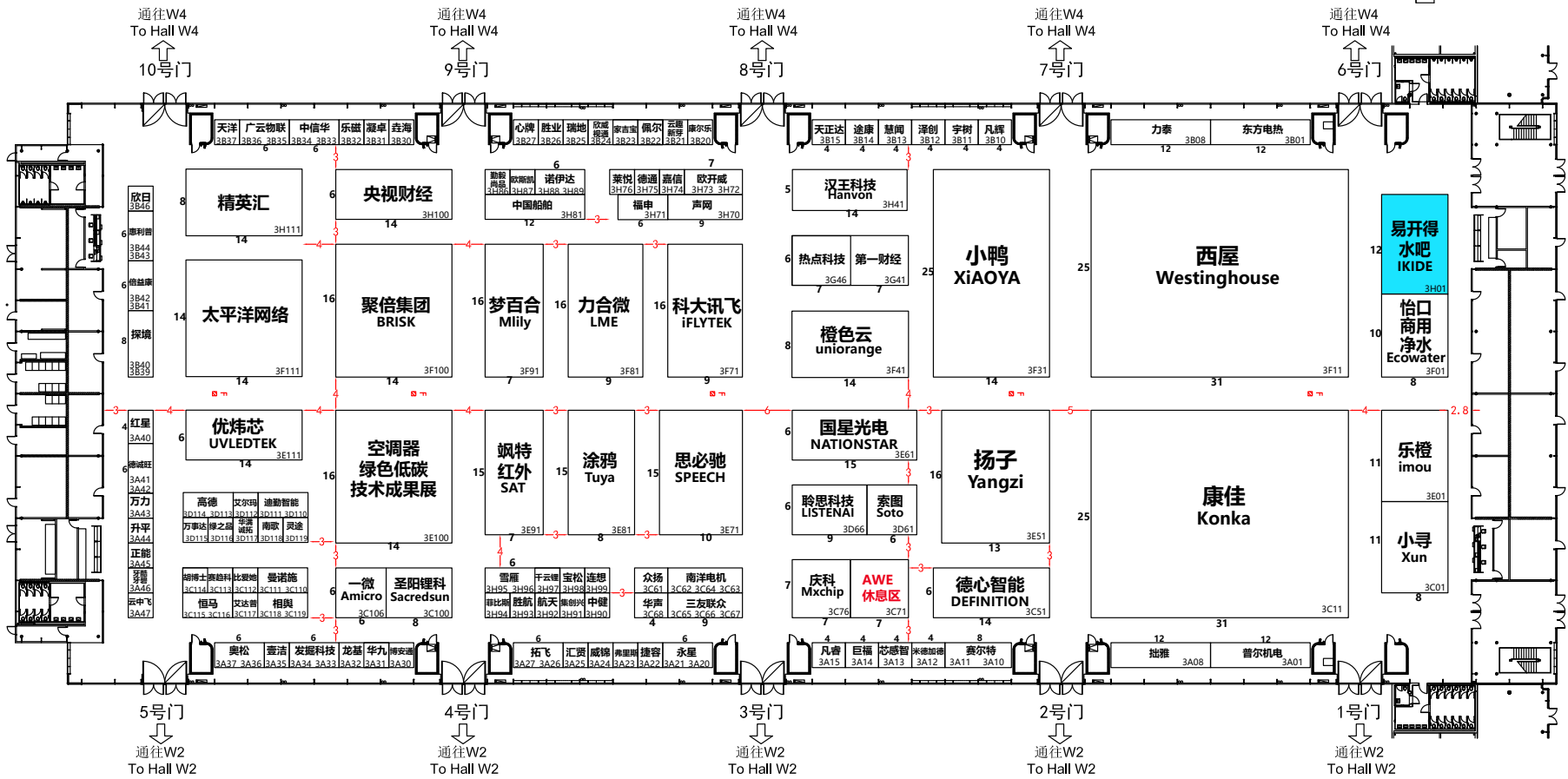
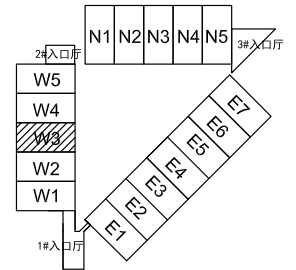





# W5 消费电子、智能家电馆

Consumer Electronics, Smart Appliances

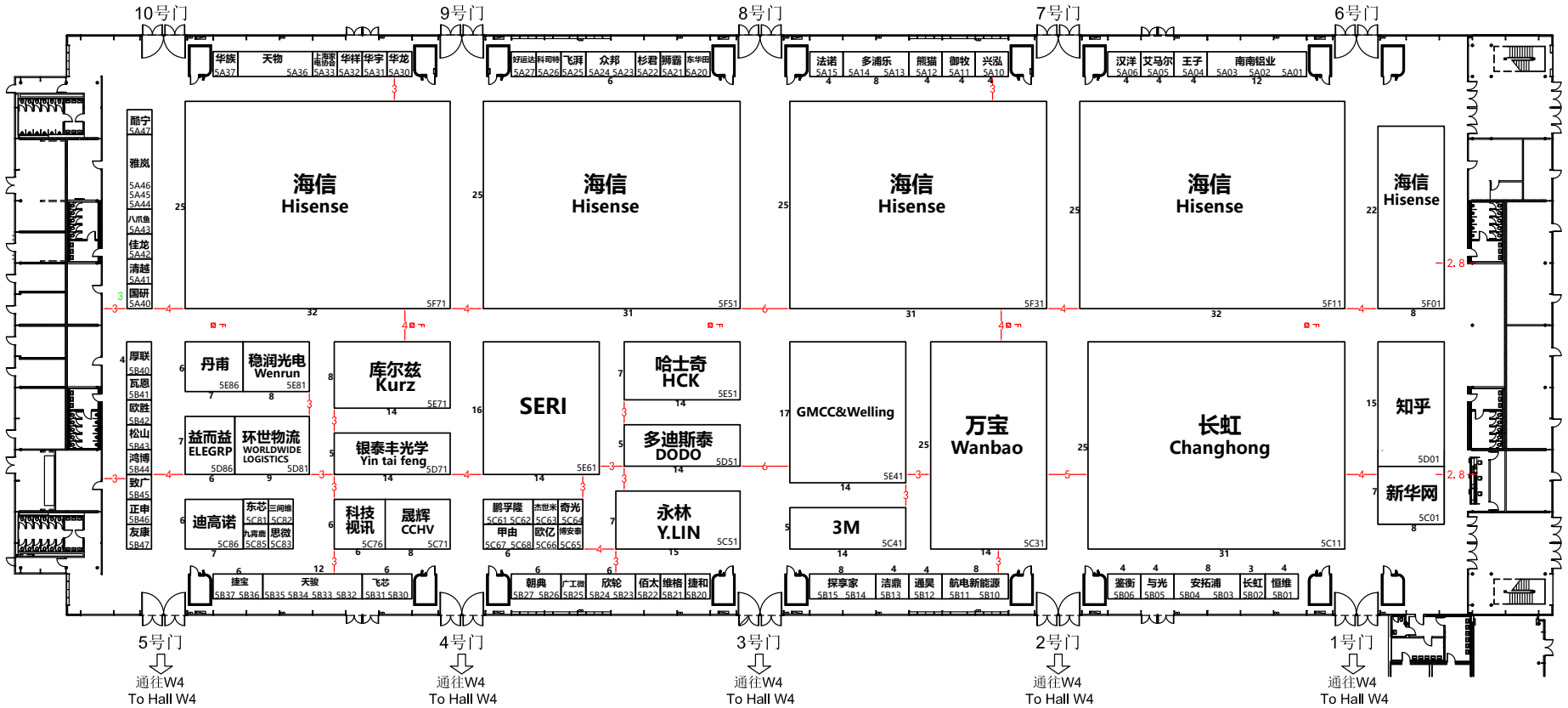
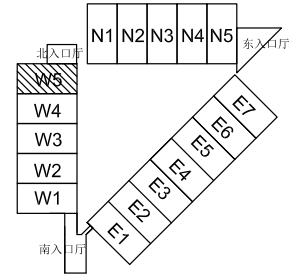



# 京东家电 五一焕新周

京东家电AWE·五一焕新周  
家电家居一条龙龙龙龙龙搞定



家电新品一键下单，享三连福利  
12期免息 | 以旧换新10%起 | 买贵双倍赔

# 65°C高温制冷 火炉也清凉

第二代格力冷酷外机



千万用户的冷静之选



注：65°C高温制冷数据以冷静王®挂机为检测，检测来源于实验室和实验室，测试环境不同，数据会有差异，不同产品规格存在差异，具体以格力官方数据为准。



ROBAM老板

ROKI 数字厨电

SKYWORTH 创维



AI烹饪助理  
ROKI先生

老板数字厨电  
AI自动烹饪 想吃的都能做

智能炒菜控制装置和系统专利号：ZL 2020 2 2601110.7



# 创维壁纸电视

独立主机 | 无缝贴墙





SONY

## 重新构建视听想象

由XR认知芯片驱动的BRAVIA XR电视，呈现出耀眼的亮度、令人惊叹的色彩和细腻清晰度的，为您带来身临其境的娱乐视听体验。



BRAVIA XR

为娱乐而生

Miele

德国美诺 Miele  
品质超越时代\*

展位号：N4\_4F61-4F71



扫二维码  
获取更多产品及活动信息

\*此概念旨在表示Miele产品以品质可靠、经久耐用为追求目标，但不构成我们对任何产品使用年限的任何保证、担保或承诺。



SHARP



夏普家  
生活+



AQUOS XLED

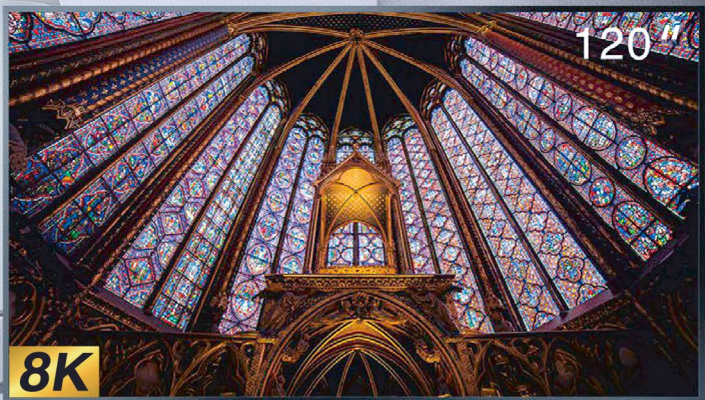

8K



百年博世 德国精制  
N4-4C31

博世 科技成就生活之美





# 智能精控技术 让日常超乎寻常



方太品牌全球代言人  
陈坤

## 方太集成烹饪中心 上排集成 引领高端厨电

X系列 | 超薄不跑烟\* 万能\*灶蒸烤

© 2018 方太集团。方太集团是西门子股份公司的商标被许可方。



Panasonic

松下电器

# 松下盛宴 邀您品鉴

AWE 2023中国家电及  
消费电子博览会



**AWE** AWE 2023  
中国家电及消费电子博览会

展位地址：国际品牌馆N4馆-4F11  
活动时间：2023.04.27 ~ 04.30



扫描活动二维码  
解锁更多新奇玩法~

Electrolux

Swedish thinking. Better living

瑞典灵感 品质生活





奥知音 II

语音轻松控  
方言更秒懂



语音小精灵2.0



潮流极简美学



第五代自动水洗





万家乐

# 万家乐致极PRO套系

致简智美 至净新厨

超薄低吸油烟机 | 双高匀火燃气灶 | 小体积燃气热水器



展位：N2馆-2F41  
广东万家乐燃气具有限公司  
☎ 400-128-8888



万家乐官方商城



万家乐官方微信

KONIKA 康佳

康佳极光套系即将亮相



康佳品牌代言人  
— 金晨 —



## 科大讯飞 用人工智能建设美好世界

科大讯飞股份有限公司成立于 1999 年，是亚太地区知名的智能语音和人工智能上市企业。自成立以来，长期从事语音及语言、自然语言理解、机器学习推理及自主学习等核心技术研究并保持了国际前沿技术水平；积极推动人工智能产品研发和行业应用落地，致力让机器“能听会说，能理解会思考”，用人工智能建设美好世界。

## 打造“高效办公、智慧生活”的AI消费品

讯飞消费者产品是将科大讯飞深耕22年的人工智能与智能语音技术应用到C端产品中，在AI办公领域，讯飞开拓了智能录音笔、智能办公本、翻译机、会议耳机等品类，在AI健康领域，讯飞也推出了讯飞智能助听器产品，未来，科大讯飞还会持续生根并探索消费者场景，通过调研和洞察，推动更多“高效办公、智慧生活”的消费产品落地。

# 讯飞智能产品家族

用人工智能共创美好生活 让每个人享受AI科技



## 箭牌家居 生活智慧

智净™系统 致敬生活



扫描二维码  
获取箭牌最新资讯



# 思必驰科技股份有限公司

思必驰是一家国内专业的对话式人工智能平台型企业。公司以“沟通万物、打理万事”为使命，基于公司自主研发的全链路智能对话系统定制开发平台和人工智能语音芯片，围绕“云+芯”进行布局，提供软硬件结合的人工智能技术与产品服务，实现普适的智能人机信息交互。在智能家电、智能汽车、消费电子等物联网领域，以及以数字政企类客户为主的生产、生活和社会治理领域（涵盖金融服务、交通物流、地产酒店、政务民生、医疗健康等行业场景），公司提供智能人机交互软件产品、软硬一体化人工智能产品以及对话式人工智能技术服务。

## 感知智能



### 信号处理

回声消除  
波束成形  
人声检测  
自动增益



### 语音识别

实时云识别  
长语音识别  
本地语音识别  
抗噪及远场识别



### 语音识别++

语音唤醒  
声纹识别  
情绪识别  
年龄识别



### 语音合成

童音/标准/名人  
声音复刻  
大数据深度定制  
小数据快速定制

## 认知智能



### 多模态感知及显示

语音模态  
语言模态  
视觉模态  
触觉模态  
抬头显示



### 自然语言处理及生成

意图理解  
机器翻译  
信息抽取  
预训练  
信息检索  
用户建模  
文本情感识别



### 知识计算及问答

知识本体构建  
知识抽取  
知识融合  
知识推理  
知识计算



### 全双工对话管理

上下文理解  
对话决策  
智能纠错  
意图澄清  
语义打断  
启发式对话

# 恒洁 HEGII

选品质 就是选生活

📍 N1号馆-1C01 1C11



思必驰  
微信公众号

商务及媒体合作可联系: marketing@aispeech.com

www.aispeech.com



恒洁 | 人民日报社品牌强国计划成员企业

vatti 华帝

认真生活

好用·好看·好清洁

# 华帝集成烹饪中心

一米空间七合一, 15分钟4菜1汤\*



*Rona Quip*

华帝品牌代言人：  
欧阳娜娜



# 金牌



## 金牌 | 集成厨房

### 烹、洗、存 一体集成

好看 | 好用 | 省心 | 省钱



\*“一米空间七合一”：该产品集成烟机、灶具、蒸箱、烤箱、空气炸锅、高温炖盅、保温饭盒，在一米橱柜、厨柜面积与空间内实现七大功能的集成。  
\*“15分钟4菜1汤”：此数据由华帝实验室在一定实验条件下得出，实际会因烹饪菜式、烹饪技巧等因素而有所改变。



anward 万和  
让家更温暖



中国航天事业  
战略合作伙伴

欢迎参观万和展位  
展位号:N2-2C21



载人航天  
太空厨房研制单位

Joyoung 九阳

太空科技  
悦享健康



孙颖莎

乒乓球世界冠军  
万和品牌代言人 孙颖莎

万和热水器  
万和厨房电器  
全球超一亿\*用户的温暖选择

燃气热水器 | 电热水器 | 燃气采暖热水炉 | 空气能热泵 | 多能源热水系统 | 吸油烟机  
燃气灶 | 消毒柜 | 蒸烤一体机 | 洗碗机 | 净水器 | 集成灶 | 厨房烹饪中心 | 净洗中心

备注：数据来源公司内部产品销售及安装数据综合测算所得，数据仅供参考

万和电气  
股票代码:002543



九阳变频轻音破壁机 B1

九阳不翻面空气炸锅 V1 Fast

九阳 0 涂层不粘电饭煲 N1S

九阳太空热小净 R5 加热净水器

\*“太空科技”指的是九阳公司作为载人航天太空厨房研制单位，已研制出相关太空厨房配套产品并运用到载人航天太空厨房中。



SUPOR 苏泊尔

# 粒粒透芯 口口香传

新一代苏泊尔远红外电饭煲



联合开发 权威认证 中国水稻研究所  
国家红外及工业电热产品质量监督检验中心

远红外电饭煲定义8A好米饭\*

\*数据说明：数据来自华中农业大学食品科学技术学院，测试方式以4杯东北米为测试样品，测试机型为SF40HC87(远红外IH电饭煲)，评级标准为中国电协会发布的团体标准《电饭煲烹饪米饭品质评价方法》，香气、平整度、蓬松度、膨胀率、沸孔、水分偏差、含水率、糊化度达到该标准A级；因为环境影响会有误差，具体以实际烹饪效果为准。

PHILIPS

飞利浦G5系列全屋净水

## 德国进口\* 精工品质

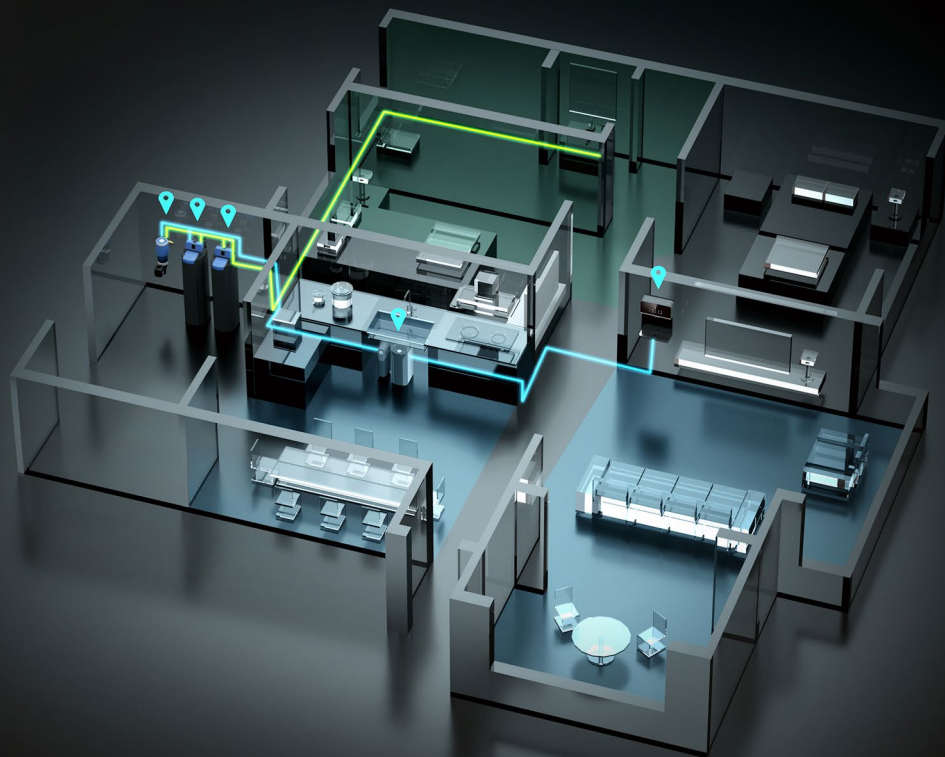

全屋 · 纯净 · 健康



前置过滤器



中央净水机



中央软水机



厨下净水器



管线机

\*德国进口，特指G5系列的前置过滤器、中央净水机、中央软水机的主机部件。

\*\*飞利浦G5系列：前置前置过滤器AWP1876；中央净水机AWP9837；中央软水机AWP9845、AWP9846、AWP9847；厨下净水器AUT8005R16/93、AUT8005R21/93；管线机ADD4825。

# LEXY 莱克

让世界更干净

## 天狼星 S680

洗地·吸尘·除螨  
有一台天狼星就够了



控水洗地  
湿擦地板,干一点更好



强力拍打地毯  
深层细灰细菌,拍得起吸得净



沙发除螨吸尘  
强拍打真除螨



镁合金防水电机  
吸力提升100%\*

地毯吸尘  
细灰拍得起吸得净

控水洗地  
湿擦地板干一点更好

手持随手吸  
全屋清洁一气完成



\*对比莱克老款型号

# Rinnai 林内



## 林内健康生活全屋解决方案

采暖 厨电 热水 净水



上海林内有限公司

地址:上海市奉贤区团青公路4500号 邮编:201411 总机:021-67583500 传真:021-67583555  
全国监督咨询热线:400-699-0606 www.rinnai.com.cn



关注林内更多信息



Küppersbusch | TEKA  
FÜR KÜCHEN MIT STIL

世纪设计大师 乔治·亚罗联名款系列产品  
第五届进博会央视新闻全球首发

探索  
Infinity | G1 Edition

让奢华不再遥不可及

GERMAN HEART, ITALIAN DESIGN



展位号: N4 4C 81  
欢迎莅临指导



探索西屋  
[www.westinghouse.cn](http://www.westinghouse.cn)

Westinghouse



ECOVACS  
ROBOTICS



DEEBOT X1 MI



DEEBOT X1 MI



GOAT S1



DEEBOT X1 OMNI



AIRBOT X1

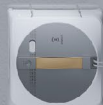

WINBOT X1 PRO

tineco 添可  
生活白科技 | 居家小确幸

智能科技 点亮生活



智能洗地机 | 智能料理机 | 智能蒸烤炸一体机 | 智能净热一体机 | 智能吹护机 | 智能美发梳



# ASD 爱仕达

展位号: N3 3C21

## 品味生活 品味爱

TASTE MORE FROM LIFE



爱仕达全球品牌代言人  
孙俪



官方微信号

# Bear 小熊

年轻人喜欢的小家电



## 有想法 玩出花儿

创新多元 | 精致时尚 | 小巧智能

📍 展区位置 | E2-2F11

更多资讯关注

小熊电器股份有限公司

电话: 4006622580

电子邮箱: bears@bears.com.cn



公众号@小熊电器



微博@小熊电器



抖音@小熊官方旗舰店



MEIDA 美大  
中国美厨房

集成灶发明者  
掌握核心科技

A股上市公司 股票代码：002677

# 变频大吸力

# 1秒吸油烟

## 美大变频集成灶



全国销售热线 400-887-3397 全国服务热线 400-887-9882

浙江美大实业股份有限公司 浙江省海宁市袁花镇谈桥81号 (海宁东西大道60KM)



扫码关注美大官方微信

MQ名气

# 名气爆炒大吸力集成灶

## 爆炒不呛鼻

老板集团出品

名气蒸烤炸一体集成灶939FT



加盟热线：0571-86213213 微信：18868157761(总部客服)

全国统一服务热线：400 886 8588



扫码添加微信 获取财富密码



AOTIN 奥田

让每一餐都健康快乐



# 奥田微蒸烤 双胆集成灶

左|微蒸消 右|蒸烤炸

1+1=25种\*烹饪组合

招商热线 | 400-672-6388

\*1+1=25指奥田微蒸烤集成灶可操作的功能组合数量

浙江奥田电器股份有限公司  
ZHEJIANG AOTIN ELECTRIC APPLIANCES CO.,LTD

奥田官方网站: [www.aotin.net](http://www.aotin.net)

展位号: N1-1C51

AUCMA  
澳柯玛

## 让世界新鲜如初

澳柯玛高端明星产品

我的安心之选



澳柯玛品牌代言人: 孙俪



# HITACHI

## 一切, 净如所愿

Intelligence, Wash As I Wish

日立「巧克力」系列



平板外观



一键智能洗



风翼斗技术



超大容量

阿奇立克日立家用电器(上海)有限公司

Arcelik Hitachi Home Appliances (Shanghai) Co., Ltd.

# Canbo 康宝

## 康宝消毒柜连续10年

## 全国销量第一\*

\*数据来源: 奥维云网2013-2022年全国消毒柜销量统计康宝销量第一



地址: 广东省佛山市顺德区杏坛镇齐新路268号

电话: 400-700-0818 主页: [www.canbo.cn](http://www.canbo.cn)



# CeMeta 森宇宙

森宇宙CeMeta是森博营销集团旗下元宇宙数字科技公司，  
基于元宇宙时代和AIGC技术应用，  
探索前沿营销方式和未来数字生活的变革。

C e M e t a 智 能 数 字 人 曦 X I

## CenMetaHome

数字家庭空间品牌，  
拓展元宇宙数字化生活方式。  
构建用户数字世界的入口与归处。

## AI数字人产品

将AIGC能力与应用场景相结合，  
构建全新数字人智能交互解决方案。

## AI产品图产品

利用AIGC与三维建模技术，  
快速低成本为品牌提供  
产品场景图拍摄服务。

## 创新展览展示产品

基于虚拟场景构建能力和VR、AR等  
数字化交互方式，  
打造产品创新展览展示。

SENG 森歌

高端集成灶品牌



体育·训练局赞助商

# 智能清洁 专业烹饪

蒸烤内胆智清洁 | 专业双风炉烤



ZB智清洁系列 | 蒸烤箱内胆智清洁技术

TMALL天猫

森歌旗舰店



# 森歌集成灶

**CUORI卓力**

国际熨烫传奇

一熨瞬时唤醒  
点触尽显灵动



**石头**

用创新简化生活



<https://www.roborock.com/>



DREAME 追觅



DREAM SMART  
DREAM BIG

科技造梦 追觅不止

EUNA

优诺复古冰箱

生活艺术家



地址: 杭州市经济技术开发区3号大街19号1-9幢  
电话: 0571-28876819



BISSELL® 必胜

# 家的干净 必胜使命

洗地机系列全球销量超过500W台<sup>+</sup>\*



扫码关注BISSELL必胜

\*数据来源: 必胜内部数据, 统计自CrossWave首款产品上市以来

YUELI 月立 | ShowSee 小适



## 爱就全速热爱 记录你的起风时刻

小适高速电吹风 (水膜系列)

60s恒温速干 水润护养

11万转高速电机 | 2亿负离子 | 冷热循环风 | 55°C智能恒温





Canature  
开能净水

净水行业上市公司 股票代码:300272

捷赛  
Gemside

右来了科技  
YO TECHNOLOGY

展位号:N3馆-3F01

全球领先的一站式水处理解决方案提供商

开能净水成立于2001年,是国人居水行业上市公司,开创“全屋净水·全家健康”理念,致力于为全球用户提供更具价值的净水产品和服务,创造健康美好生活。产品出口100多个国家与地区<sup>①</sup>,连续为2008北京奥运会、2010上海世博会、2011上海世界游泳锦标赛、上海著名国家旅游度假区<sup>②</sup>提供饮用水净化保障。

六大全球研发制作基地



开能上海 开能浙江 开能江苏 开能广东 开能美国 开能加拿大

家用、商用净水产品全覆盖



<sup>①</sup>出口国家数量为截至2023年12月的集团内部数据统计  
<sup>②</sup>日均水质检测合格资质证书



上海奔泰水处理设备有限公司  
网址: www.canaturewater.com/www.canature-global.com  
地址: 上海市浦东新区川大路508、518号

400-820-1199



捷赛

智能厨电

防溢专利 | 智能温控 | 私房美味



关注公众号  
了解“捷赛”更多内容



# AWE 2023

APPLIANCE&ELECTRONICS  
WORLD EXPO

中国家电及消费电子博览会

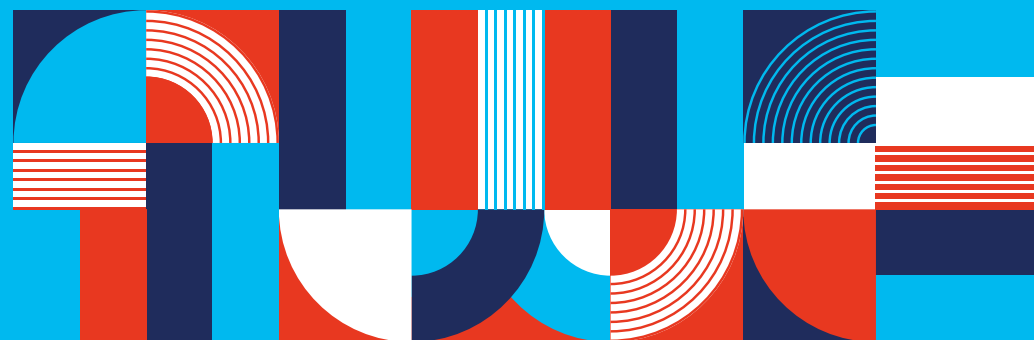

**参展商名录** (按展馆排序)

Hall Overview

参展商名录 (按字母排序)

Alphabetical List of Exhibitors

## E1 号馆 (Hall E1)

- E1-1A01 1A02 苏州地贝电器科技有限公司  
SUZHOU DIBEA ELECTRICAL TECHNOLOGY CO.,LTD
- E1-1A03 1A04 苏州荣采创新科技有限公司  
Suzhou Glorison Innovation Co., Ltd.
- E1-1A05 慈溪市凯乐电器有限公司  
Kailer Home (China)
- E1-1A06 广东顺德瑞利洁环境科技有限公司  
Guangdong Shunde ruilijie Environmental Technology Co., Ltd
- E1-1A10 深圳市鸿港电子有限公司  
SHENZHEN HONK ELECTRONIC CO.,LTD
- E1-1A11 南京大佑电子科技有限公司  
Nanjing Dayoo Electronics Technology Co., Ltd.
- E1-1A12 1A13 慈溪市斯泊林电器有限公司  
Cixi City Sibolin Electric Appliance Co.,Ltd
- E1-1A14 上海伊柯林技术有限公司  
Shanghai Ikelin Technology Co., LTD
- E1-1A15 宁波云上智能科技有限公司  
NingBo YunShang Intelligent Tehnology Co., LTD
- E1-1A20 1A21 厦门金升泵电子科技有限公司  
Xiamen Pumtek Electronics Technology Co., Ltd.
- E1-1A22 常州科能电子有限公司  
CHANGZHOU KENNON ELECTRONICS CO.,LTD.
- E1-1A23 1A24 深圳市火牛科技有限公司  
SHENZHEN HUONIU TECHNOLOGY CO.,LTD
- E1-1A25 1A26 厦门芯阳科技股份有限公司  
Xiamen Chipsun Science & Technology Co., Ltd.
- E1-1A26 东莞市先领电源有限公司  
Dongguan Sunun Power Co., Ltd
- E1-1A30 上海养贞轴承制造有限公司  
Shanghai Lily Bearing Manufacturing Co.,Ltd.
- E1-1A31 苏州睿梵工业设计有限公司  
suzhou redefine industrial design Co.,Ltd.
- E1-1A32 浙江璐瑶电子科技有限公司  
Zhejiang Luyao Electronics Technology Co., Ltd

# 你无须快一点

倍慈XS2剃须刀  
口袋里的

头等仓



- E1-1A33 1A34 深圳市航天电机系统有限公司  
Shenzhen Casic Motor System Co.,Ltd.
- E1-1A35 1A36 厦门坤锦电子科技有限公司  
Xiamen Conjoin Electronics Technology Co., Ltd.
- E1-1A37 东莞市倍增电子有限公司  
Analog Power Electronic Co.,Ltd
- E1-1A40 东莞圆锋电子有限公司
- E1-1A41 1A42 宁波一云电器科技有限公司
- E1-1A43 1A44 厦门科际精密器材有限公司  
Xiamen Koge Micro Tech Co.,Ltd
- E1-1A45 深圳市同创新精密电子有限公司  
ShenZhen TopSharp Precision Electronics Co., Ltd
- E1-1A46 1A47 宁波泰威特电器有限公司  
Ningbo Taiweite Electric Appliance Co.,Ltd
- E1-1B01 宁波洁嘉电器科技有限公司  
Ningbo Jiejia Electronics Technology Co., LTD
- E1-1B02 宁波格瑞塑业有限公司  
Ningbo Gerui Plastic Co., Ltd
- E1-1B03 1B04 广东金力智能传动技术股份有限公司  
Guangdong Kingly Gear CO.,LTD.
- E1-1B05 宁波洁匠智能科技有限公司  
NINGBO JIEJIANG INTELLIGENT TECHNOLOGY CO.,LTD.
- E1-1B06 浙江悦夫人智能科技有限公司
- E1-1B10 宁波克虏伯电器有限公司  
NingBo KeLuBo ELECTRICAL APPLIANCE CO.,LTD
- E1-1B11 佛山市业航电器有限公司  
FOSHAN YE HANG ELECTRONIC CO., LTD.
- E1-1B12 东莞市领亚智能科技有限公司
- E1-1B13 1B14 深圳市德宇鑫科技有限公司  
Shenzhen Deyuxin Technology Co.,Ltd
- E1-1B15 苏州洁易电器有限公司  
Suzhou Easyclean Electric Appliance Co. Ltd
- E1-1B20 慈溪微虎电器科技有限公司  
CIXI MICROHOO ELECTRICAL APPLIANCE TECHNOLOGY CO.,LTD.

- E1-1B21 浙江耀博士科技有限公司
- E1-1B22 昆山泰瑞克智能科技有限公司  
Kunshan Tyrek Intelligent Technology Co.,Ltd
- E1-1B23 1B24 宁波日益科技有限公司  
NINGBO RIYI TECBHNOLGY CO.,LTD
- E1-1B25 苏州荣炫电器有限公司  
Suzhou Rongxuan Electric Co., Ltd.
- E1-1B26 1B27 深圳市新斯宝科技有限公司  
Shenzhen Xinspower Technology Co.,Ltd.
- E1-1B30 浙江东亿磁业有限公司  
Zhejiang Dongyi Magnetic Co.,Ltd.
- E1-1B31 东莞市联臻光电科技有限公司  
Lianzhen Optoelectronics Tech Co.,Ltd
- E1-1B32 上海承岳商贸有限公司  
Shanghai Chengyue Trading Co., Ltd
- E1-1B33 1B34 宁波哲恺电器有限公司  
NINGBO ZHE KAI ELECTRIC APPLIANCE CO., LTD
- E1-1B35 深圳玩智商科技有限公司  
Shenzhen EAI Technology Co.,Ltd.
- E1-1B36 1B37 苏州爱之爱清洁电器科技有限公司  
Suzhou AZA Clean Electric Technology Co., Ltd.
- E1-1B40 上海馨源电子有限公司
- E1-1B41 亦为超声技术(深圳)有限公司  
ultrasonic technology (Shenzhen) Co., Ltd
- E1-1B42 1B43 广东博力威科技股份有限公司  
Greenway Technology Co., LTD.
- E1-1B44 1B45 东莞市爱迪机电科技有限公司  
Dongguan ET Mechanical & Electrical Technology Co., LTD
- E1-1B46 余姚市中建电器有限公司  
Yuyao Zhongjian Electrical Appliance Co.,Ltd
- E1-1B47 福州景腾精工橡塑制品有限公司  
Fuzhou Jingteng Seiko Rubber &Plastic Co,Ltd
- E1-1C01 深圳市启为机器人技术有限公司
- E1-1C11 上海亿力电器有限公司  
Shanghai YILI Electric Co., ltd

E1-1C21	北京牛特机器人科技有限公司
E1-1C31	中山市家奈实业有限公司 GENE by HIROSE
E1-1C41	广东爱禾科技有限公司 Guangdong AIHE Technology Co., Ltd.
E1-1C51	大连爱丽思欧雅玛发展有限公司 IRIS OHYAMA
E1-1C61	杭州英乐特智能科技有限公司 Hangzhou IELIET Intelligent Technology Co., Ltd
E1-1C71	深圳前海西哲智能科技有限公司
E1-1C76	嘉丰工业科技(惠州)有限公司
E1-1C81	澳兰斯健康产业有限公司 Aolans Health industry Co., LTD
E1-1C86	深圳尼宝科技有限公司 Neakasa Tech Co., Limited
E1-1C91	东莞市先端光电科技有限公司 AOE
E1-1C92	乐清市纽福莱电子有限公司 YUEQING NIUFULAI ELECTRONIC CO.,LTD
E1-1C93	宁波实隆轴承有限公司 NINGBO SHILONG BEARING CO.,LTD
E1-1C94	东莞市华生益环保净化科技有限公司 Dongguan Walsen Environmental Purifying Technology Co., Ltd.
E1-1C96	常州市艾迈斯电子有限公司 CHANGZHOU AMASS ELECTRONICS CO.,LTD
E1-1C97	宁波可凡电器有限公司 Ningbo Kaffee Electric Appliance Co., Ltd
E1-1C98	宁波普净科技有限公司 NINGBO PROCLEAN CO.,LTD.
E1-1D71	佛山市冠盈金属塑料制品有限公司 Top Profit Manufacturing Co., Ltd.
E1-1D76	东莞市品佳智能科技有限公司 Dongguan Pinjia Intelligent Technology Co.,Ltd.
E1-1D81	宁波福瑞电子科技有限公司 NINGBO FOURA ELECTRONICS CO.,LTD

E1-1D86	温州智荣健康科技有限公司 Wenzhou Zhirong Health&Science Technology Co., Ltd
E1-1E01	广东海清环保科技有限公司深圳分公司 Hikins
E1-1E11	北京石头世纪科技股份有限公司
E1-1E21	追觅科技 dreame
E1-1E31	深圳市杉川机器人有限公司
E1-1E41	艾美特电器(深圳)有限公司 AIRMATE ELECTRIC (Shenzhen) Co., LTD.
E1-1E51	宁波凡浦智能科技有限公司 Ningbo VEMPU Intelligent Technology Co., Ltd,
E1-1E61	北京赫特智慧科技有限公司 Beijing Hutt Intelligent Technology Co.,Ltd.
E1-1E71	宁波赛特斯电器有限公司 NINGBO CETUS ELECTRIC APPLIANCE CO.,LTD
E1-1E81	浙江弩牌电器有限公司 Zhejiang Crossbow Brand Electric Appliance Co.,Ltd
E1-1E86	JOOSUNG
E1-1F01	汉斯希尔贸易(上海)有限公司 SYR TRADING (SHANGHAI) CO.,LTD
E1-1F11	科沃斯机器人股份有限公司 ECOVACS Robotics Co., Ltd.
E1-1F21	卡赫贸易(中国)有限公司 Kaercher Trading (China) Co.,Ltd.
E1-1F31	必胜益康(上海)智能科技有限公司 BISSELL (Shanghai) Innovation Technology Co. Ltd.
E1-1F41	卓力电器集团有限公司
E1-1F51	深圳赤马人工智能有限公司 Shenzhen Red Horse AI Co.,Ltd.
E1-1F61	深圳市汇奇美科技有限公司 Shenzhen Huiqimei Technology Co., Ltd
E1-1F71	深圳市瑞松电器有限公司
E1-1F81	北京众清科技有限公司 CoClean Technologies Co.,Ltd.



E1-1F86	宁波未十电器科技有限公司
E1-1G61	上海同温层智能科技有限公司
E1-1G66	东莞共全海外品牌策划有限公司
E1-1G71	宁波木本生活电器有限公司 Ningbo Muben Life Electric Appliance CO.,LTD.
E1-1G76	奥戈那(西安)贸易有限公司 OGNAL TRADING CO., LIMITED
E1-1G81	上海团宝智能科技有限公司 Mamibot Manufacturing (Shanghai) Co.,Ltd.
E1-1G86	佛山市功匠电器科技有限公司
E1-1H11	一芯家科技(常州)有限公司
E1-1H21	艾迪宝科技 IDEEBO
E1-1H31	深圳以内创新科技有限公司 Shenzhen Inxni Innovation Technology Co., Ltd
E1-1H41	上海红心器具有限公司 Shanghai Hongxin Appliances co.,ltd
E1-1H51	佛山市顺德弘金电器科技有限公司 Shunde Kingtec Appliances Co.,Ltd.
E1-1H61	湖北滴水科技有限公司 Hubei Diisea Technology Co., Ltd
E1-1H71	深圳市浦力适贸易有限公司 Shenzhen Purest Trading Co.Ltd
E1-1H76	苏州聚邦电器有限公司 Suzhou GB-Tech Cleaning Appliance Co., Ltd.
E1-1H81	宁波横河精密工业股份有限公司 Ningbo Henghe Precision Industry Co., Ltd.
E1-1H86	江门西子电器科技有限公司 SEEDEN

## E2 号馆 (Hall E2)

E2-2A01	上海芯垣电子科技有限公司 Shanghai Xinyuan Electronic Technology Co.,Ltd
---------	--

E2-2A02	佛山市顺德区富升电子科技有限公司 FOSHAN SHUNDE FUSEN ELECTRONIC TECHNOLOGY CO., LTD
E2-2A03	深圳市方之界科技有限公司 SHENZHEN FANGZHUIJIE TECHNOLOGY CO.,LTD
E2-2A04	勤耕云智能科技(深圳)有限公司 Shenzhen Transtar Electronics Co., Ltd.
E2-2A05	广东顺德锐铂汇电子科技有限公司 GUANGDONG SHUNDE RAINBOW WAY TECHNICAL CO., LTD.
E2-2A06	宁波埃玛电器制造有限公司
E2-2A10 2A11	浙江米技创意设计有限公司 zhejiangmijicreativeDesignco,LTD
E2-2A12	东莞市亚美世电子科技有限公司 Yumyth Electronic Tech Co.,Ltd
E2-2A13	中山格福美电器有限公司 Zhongshan GorFame Electrical Appliance Co
E2-2A14	宁波欧声电器有限公司 NINGBO ALLSING ELECTRICAL APPLIANCE CO.,LTD
E2-2A15	深圳市魔品科技有限公司 Shenzhen Mopin Technology Co.,Ltd.
E2-2A20 2A21	慈溪市香格电器有限公司
E2-2A22	锐莫(佛山)电器科技有限公司 RIMOO (FOSHAN) ELECTRICAL APPLIANCE TECH CO., LTD
E2-2A23 2A24	浙江朝晖过滤技术股份有限公司 Zhejiang Zhaohui Filter Technology Co., Ltd.
E2-2A25	宁波朝一电子有限公司 Ningbo Joil Electronics Co.,Ltd.
E2-2A26 2A27	深圳市荣为信科技有限公司 Shenzhen Rongweixin Technology Co., Ltd.
E2-2A30	苏州志佳电子科技有限公司 SUZHOU ZEKA ELECTRONIC TECHNOLOGY CO.LTD
E2-2A31	苏州迈皓电器有限公司 Suzhou Maihao Electric Co., Ltd
E2-2A32	宁波市长利自动化电器有限公司 NINGBO CHANGLI AUTOMATIC APPLIANCE CO.,LTD.
E2-2A33 2A34	深圳市百乐奇显示有限公司 Topovision Technology Co.,Ltd.

E2-2A35	永康市乐事智能科技有限公司
E2-2A36 2A37	宁波千帆智能科技有限公司
E2-2A40 2A41	宁波图兰多电器有限公司 Ningbo Turando Electrical Appliances Co.,Ltd
E2-2A42	浙江合治科技有限公司
E2-2A43	杭州慧亿科技有限公司 HANGZHOU HUIYI TECHNOLOGY Co.,Ltd.
E2-2A44	深圳洁盟技术股份有限公司 SKYMEN SONIC GROUP LIMITED
E2-2A45	上海颂道卫浴设备有限公司 SHANGHAI SODAO SANITARYWARE EQUIPMENT CO.,LTD
E2-2A46 2A47	中山市掌声电器有限公司 Zhongshan Josoo Electric Appliance Co.,Ltd
E2-2B01	佛山市奥力给电器有限公司 Foshan oliga Electric Co.,Ltd
E2-2B02	合肥和正医疗科技有限公司 Hefei Hezheng Medical Technology CO.,Ltd
E2-2B03	宁波凯迪利电器有限公司 Ningbo Kedly Appliance Industry Co.Ltd.
E2-2B04	深圳市盟迪奥科技股份有限公司
E2-2B05	宁波嘉林电子有限公司 NINGBO JIALIN ELECTRONICS CO.,LTD
E2-2B06	佛山市格林盈璐电器科技有限公司 Foshan GreenYellow Electric Technology Co.,Ltd
E2-2B10 2B11	苏州威摩尔智能科技有限公司 Suzhou Womow Intelligent Technolgy Co., Ltd.
E2-2B12	中山市君拓电器有限公司
E2-2B13	宁波市清朗电器有限公司 Ningbo Qinglang Electric Appliance Co., LTD
E2-2B14	新乡市杰达精密电子器件有限公司 Xinxiang Jieda Precision Electronics Co., Ltd.
E2-2B15	宁波昆凌智能科技有限公司
E2-2B20 2B21	慈溪市贝联电器有限公司 Cixi Beilian Electrical Appliance Co.,Ltd.

E2-2B22	东莞科立派净化科技有限公司 Dongguan Kelipai Purification Technology Co.,Ltd
E2-2B23	宁波万泓科技有限公司 Ningbo Wanhong Technologies Co.,Ltd.
E2-2B24 2B25	广州优端环保科技有限公司 Guangzhou Youduan Environmental Protection Technology Co., Ltd.
E2-2B26	温州科信健康产品有限公司 Wenzhou Kexin Health Product Co., Ltd.
E2-2B27	慈溪市梦森电器有限公司
E2-2B30 2B31	宁波富达智能科技有限公司 NINGBO FUDA INTELLIGENT TECHNOLOGY CO,LTD.
E2-2B32	佛山市世鼎科技有限公司 Foshan Shiding Technology Co., Ltd.
E2-2B33 2B34	慈溪市卓家电器厂 CIXI ZHUOJIA ELECTRIC APPLIANCE FACTORY
E2-2B35	浙江凯成云母材料有限公司 Zhejiang Kaichen Mica Material CO.,Ltd.
E2-2B36 2B37	东莞市净诺环境科技股份有限公司 Dongguan JingNuo Environment Science and Technology Inc.
E2-2B40 2B41 2B42	上海通业轻工制品有限公司 Shanghai Toye light industrial products Co., Ltd
E2-2B43	佛山市炜皓电器科技有限公司 FOSHAN SUNRAYS ELECTRICAL TECHNOLOGY CO., LTD
E2-2B44 2B45	佛山市活力源电子科技有限公司 Foshan Lifecode Electronic Tech. Co., Ltd
E2-2B46	苏州英诺克电器有限公司 Suzhou Innovac Electric Co., Ltd
E2-2B47	苏州工业园区安泽汶环保技术有限公司 Azurewind Cleantec (S.I.P.) Co., Ltd.
E2-2C01	易恩得(北京)品牌管理有限公司 E&W Co.,Ltd
E2-2C11	浙江绍兴苏泊尔家居用品有限公司 Zhejiang Shaoxing SUPOR household products Co., Ltd
E2-2C21	广东美领互联科技股份有限公司 Guangdong Meiling Internet Technology Co., Ltd.



E2-2C31	上海鹤立心选网络科技有限公司 Shanghai helixinxuan Network Technology Co., Ltd
E2-2C41	广东天俦智能家居有限公司 Guangdong Timzoo Electric Appliances Co.,Ltd
E2-2C51	佛山市顺德区古今工业设计有限公司 Foshan Shunde Gujin Industrial Design Co., LTD
E2-2C51-01	佛山卡蛙科技股份有限公司
E2-2C51-02	广东顺德米壳工业设计有限公司 Mikodesign
E2-2C51-03	佛山市睿拓工业设计有限公司 Foshan Ratop Industrial Design Co., Ltd.
E2-2C51-04	佛山市众意工业设计有限公司 Foshan Zhongyi Industrial Design Company Limited
E2-2C51-05	佛山市方块工业设计有限公司 Foshan Square industrial design Co., Ltd
E2-2C51-06	广东顺德潜龙工业设计有限公司 Chinno Industrial Design Co., Ltd.
E2-2C51-07	佛山市奇门设计顾问有限公司
E2-2C51-08	佛山市顺德区宏翼工业设计有限公司 FOSHAN HONGYI INDUSTRIAL DESING CO.,LTD
E2-2C51-09	佛山市三人一物工业设计有限公司
E2-2C51-10	佛山市汉秀创意设计有限公司 Foshan hanxiu Idea Design Co., Ltd
E2-2C51-11	佛山市顺德区古今工业设计有限公司 Foshan Shunde Gujin Industrial Design Co., LTD
E2-2C51-12	佛山凯缔文化创意有限公司
E2-2C51-13	佛山市顺德区唯点工业设计有限公司 Vee Design Consulting Co.,Ltd.
E2-2C61	厦门唯科健康产业有限公司 Xiamen Vork Health Industry Co., Ltd.
E2-2C66	中山安铂尔电器有限公司 Zhongshan Anboer Electric Appliance Co., Ltd.
E2-2C71	杜邦中国集团有限公司 DuPont China Holding Co., Ltd.

E2-2C76	宁波绿森林电子科技有限公司 NINGBO GREEN FOREST ELECTRONIC TECHNOLOGY CO.,LTD
E2-2C81	苏州瑞久智能科技有限公司
E2-2C86	国统电器科技(惠州)有限公司 Kuo Tong Electrical Technology (huizhou) Co.,Ltd
E2-2D61	厦门越一电子科技有限公司
E2-2D66	宁波泉立佳电器有限公司 Ningbo QuanRia Electrical Appliance Co.,Ltd.
E2-2D81	郑州炜盛电子科技有限公司 Zhengzhou Winsen Electronics Technology Co., Ltd.
E2-2D86	东莞市优尼雅电子科技有限公司 Dongguan Yulia Electronic Technology Co., Ltd.
E2-2E41	莱克电气股份有限公司
E2-2E61	家里泉健康科技(苏州)有限公司 Jialiquan Health Technology (Suzhou) Company Limited
E2-2E71	广东顺德斗禾电子科技有限公司 Guangdong Shunde DOUHE Electronics Technology Co., Ltd
E2-2E81	宁波美博力特电器有限公司 Ningbo Amberade Electric Appliance Co.,Ltd
E2-2F01	深圳市鼎信商贸有限公司 Shenzhen Dingxin Trading Co., Ltd
E2-2F11	小熊电器股份有限公司 The Bear Electric Appliance Co., Ltd.
E2-2F21	傲胜 OSIM
E2-2F31	上海水护盾健康科技有限公司 Philips Water Solutions
E2-2F41	广东德尔玛科技股份有限公司 Guangdong Deerma Technology Co., Ltd.
E2-2F51	浙江艾波特环保科技股份有限公司 Zhejiang Aibote Environmental Technologies INC.
E2-2F61	抖音电商
E2-2F71	漳州灿坤实业有限公司 TSANN KUEN (ZHANG ZHOU) ENTERPRISE CO.,LTD

E2-2F81	宁波爱科特环境电器有限公司 NINGBO AQUART ENVIRONMENTAL APPLIANCE CO.,LTD
E2-2G71	大连汉和住生科技有限公司 Dalian Kanwajuusei Technology Co.,Ltd
E2-2G76	佛山市弗尔圣电子科技有限公司
E2-2G81	宁波市金狼电器有限公司 Ningbo Kinglong Electric Appliance CO.,LTD
E2-2G86	阿尔卡司(成都)空气净化技术有限公司
E2-2H21	中山市欧莱克电器有限公司 Zhongshan oulaike electrics co., ltd
E2-2H51	昂特华德(上海)品牌管理有限公司 ernte Co.,Ltd
E2-2H61	广东顺德爱登创意日用品有限公司
E2-2H66	咖啡自由 KAXFREE
E2-2H71	上海日机装贸易有限公司 Shanghai Nikkiso Trading Corporation
E2-2H76	中山市朗田电器有限公司 ZHONGSHAN LONTAN ELECTRICAL INDUSTRY CO.,LTD
E2-2H81	河南三元光电科技有限公司 HE NAN SAN YUAN PHOTOELECTRLC TECHNOLOGY CO.LTD
E2-2H86	宁波升谱光电股份有限公司 NINGBO SUNPU LED CO.,LTD.

## E3 号馆 (Hall E3)

E3-3A01	杭州高瓴环境科技有限公司 Hangzhou Gaoling Environmental Technology Co., Ltd
E3-3A02	佛山市展远电子有限公司 Foshan City Zhanyuan Electronics Company Limited
E3-3A03 3A04	福安市茗振电子有限公司 Fushi mingzhen electronics co., ltd
E3-3A05 3A06	深圳柏斯曼电子科技有限公司
E3-3A10 3A11	深圳市小泽智能科技有限公司 Shenzhen Xiaoze Intelligent Technology Co., Ltd

E3-3A12	中山智选科技有限公司 Zhongshan Zhixuan Technology Co., Ltd.
E3-3A13	纽珀水暖配件(上海)有限公司
E3-3A14 3A15	深圳市范儿科技有限公司
E3-3A20	深圳市乐乐多科技有限公司 Shenzhen LeLe Duo Technologyco.,Ltd.
E3-3A21	广东新纬电器有限公司 Guangdong Newway Electric Appliance Co., Ltd.
E3-3A22	宁波日威电器有限公司
E3-3A23 3A24	深圳大事件科技有限公司 Shenzhen Bigcase Technology Co., Ltd
E3-3A25	珠海集致科技有限公司 Zuhai Jizhi Technology Co., Ltd
E3-3A26	长沙安致美科技有限公司 Changsha Anmei Technology Co., Ltd.
E3-3A27	宁波嘉汇智能科技有限公司 NINGBO CHINWE TECHNOLOGY CO., LTD.
E3-3A30	深圳市吉奥科技有限公司 SHENZHEN GEAO TECHNOLOGY CO.,LTD
E3-3A31	深圳市创时代电子科技有限公司
E3-3A32	上海昌谊贸易有限公司
E3-3A33 3A34	深圳市言九电子科技有限公司 YJ POWER GROUP LIMITED
E3-3A35	东莞市智创源科技有限公司 Dongguan Zhichuangyuan Technology Co., Ltd
E3-3A36	余姚市佳永士电器有限公司
E3-3A37	宁波泽源电器有限公司 Ningbo Zeyuan Electrical Appliance Co., LTD.
E3-3A40	深圳市帝拓电子有限公司 Shenzhen Ditu Electronic.
E3-3A41 3A42	宁波莱可家居用品有限公司 Ningbo Laike household products Co., Ltd.
E3-3A43	宁波富爵电子科技有限公司 Ningbo Fulljoy Electronic Technology Co.,Ltd.

- E3-3A44 3A45 宁波盈兴电子科技有限公司  
Ningbo Yingxing Electronic Technology Co., Ltd
- E3-3A46 深圳市鸿昊升电子有限公司  
Shenzhen Honghaosheng Electronics Co.,Ltd.
- E3-3A47 苏州灵思实业有限公司  
Suzhou Link Sense Industry Co., Ltd
- E3-3A48 深圳市点缀文化科技有限公司
- E3-3B01 温州匹奇电器有限公司  
WENZHOU PRITECH ELECTRIC CO., LTD
- E3-3B02 深圳市齿时齿刻科技有限公司  
ShenZhen CSCK Technology Co.,Ltd
- E3-3B03 宁波科立电器有限公司  
Ningbo Keli Electric Appliance Co., LTD
- E3-3B04 深圳市萨魔科技有限公司
- E3-3B05 深圳市华鼎元电子科技有限公司  
HDY ELECTRONIC TECHNOLOGY Co.,Ltd.
- E3-3B06 东莞市恒迅微型电机有限公司  
DongGuan HengXun Micro Motor Co., Ltd.
- E3-3B10 深圳市宾多康科技有限公司  
ShenZhen Binduokang Technology Co.,Ltd
- E3-3B11 江苏美克斯智能科技有限公司
- E3-3B12 深圳市百昌科技有限公司  
Shenzhen Baichang Technology Co., Ltd
- E3-3B13 3B14 科立工业(深圳)有限公司  
Fortech Industrial(shenzhen) Limited
- E3-3B15 上海派智能源股份有限公司  
Shanghai PYTES Energy Co., LTD
- E3-3B20 东莞市灿途精密模具有限公司  
E G Enterprise Limited
- E3-3B21 南通恒嘉环保科技有限公司  
NANTONG HENKA ENVIRONMENT SOLUTIONS CO.,LTD
- E3-3B22 佛山市乐净环保科技有限公司
- E3-3B23 3B24 中山市易斯托电器有限公司  
Zhongshan Easto Electric Appliance Co., Ltd

- E3-3B25 3B26 宁波简洁日化有限公司  
NINGBO JIANJIE DAILY & COSMETICS CO., LTD
- E3-3B27 东莞市小鹿电器科技有限公司  
Dongguan Xiaolu Electrical Technology Co., Ltd Introduce
- E3-3B30 深圳市四季电子有限公司
- E3-3B31 3B32 深圳市裕欣源电子科技有限公司  
Shenzhen Yuxinyuan Electronic Technology Co., Ltd
- E3-3B33 3B34 立奇(南京)电子科技有限公司  
Liqi (Nanjing) Electronic Technology Co., LTD
- E3-3B35 余姚市德威电器电机有限公司  
Yuyao Dewei Electric Appliance Co.,Ltd
- E3-3B36 3B37 宁波神剑电器制造有限公司  
NingBo Shenjian Electrical Appliance Manufacture CO., LTD
- E3-3B40 深圳市日丽丰科技有限公司  
Shenzhen Relish Technology Co.,Ltd
- E3-3B41 3B42 慈溪市佳欢电器有限公司  
Cixi Jia Huan Electrical Appliance CO., LTD
- E3-3B43 慈溪恒宁电器有限公司  
Cixi Henning Electric Appliance Co., LTD
- E3-3B44 东莞市万恩环保科技有限公司  
Dongguan Wonen Environmental Protection Technology Co.,LTD
- E3-3B45 浙江康米科技有限公司  
ZHEJIANG KANGMI TECHNOLOGY CO., LTD
- E3-3B46 中山市七酷电子科技有限公司  
Zhongshan Seven Cool Electronics Technology Co.,Ltd
- E3-3B47 黄山市华特电器有限公司  
Huangshan Watts Electrical Co.,Ltd
- E3-3B48 广东鸿德电器有限公司  
Guangdong Hongde Electrical Co.,Ltd.
- E3-3C01 美康雅国际贸易有限公司  
Conair International Trading Limited
- E3-3C11 上海雷瓦电器有限公司  
SHANGHAI RIWA ELECTRICAL APPLIANCE CO.,LTD
- E3-3C21 浙江拜尔智能科技有限公司
- E3-3C31 东莞市康柔电器科技有限公司  
Dongguan KangRoad Electrical Techlonogy Co., LTD



E3-3C41	中山市金稻电器有限公司 Zhongshan Kingdom Electrical Co., Ltd
E3-3C51	广东康夫电器有限公司 GUANGDONG CONFU ELECTRICAL APPLIANCES CO.,LTD
E3-3C66	广东雅思电子有限公司 Guangdong Ace-Tec Co., Ltd
E3-3C71	深圳市建源达镜业科技有限公司 ShenZhen JianYuanDa Mirror Technology Co.,Ltd
E3-3C76	深圳市飞猫电器有限公司 Fly cat Electrical Co., Ltd.
E3-3C81	渲美美健(深圳)科技股份有限公司
E3-3C82	深圳智美电器股份有限公司 Iconbeauty (Shenzhen) Holding Ltd.
E3-3C83	深圳市妆主科技有限公司
E3-3C86	深圳市雅蔓谷化妆品有限公司 Shenzhen Yaman Valley Cosmetics Co., LTD
E3-3D71 3D72	宁波余通电器有限公司 NINGBO YUTONG ELECTRIC APPLIANCE CO.,LTD
E3-3D73 3D74	合肥和正医疗科技有限公司 Hefei Hezheng Medical Technology CO.,Ltd
E3-3D76	尚屋(上海)科技有限公司 SHANG HOUSE (SHANGHAI) CO., LTD.
E3-3D81	博皓 prooral
E3-3D86	深圳丽白科技有限公司 SHENZHEN LIBAI TECHNOLOGY CO.,LTD
E3-3E11	小适 showsee
E3-3E11-1	宁波朗菲生活电器有限公司 Ningbo Lofans Home Appliance Co.,Ltd.
E3-3E21	广东罗曼智能科技股份有限公司 GuangDong Roman Technology Co., Ltd.
E3-3E31	浙江超人科技股份有限公司 ZHEJIANG SUPERHUMAN TECHNOLOGY CO.,LTD
E3-3E41	杭州乐秀电子科技有限公司 Hangzhou Lexiu Electronic Technology Co., Ltd.

E3-3E81	上海筱样智能科技有限公司 Shanghai Uyang Intelligent Technology Co., Ltd.
E3-3E83	小卫 simpleway
E3-3E86	宁波博晟电器有限公司 Ningbo Bosheng Electric Co.,Ltd
E3-3F01	深圳市加减生活科技有限公司 Shenzhen XIVOLIFE Trading Co., Ltd.
E3-3F11	上海飞科电器股份有限公司
E3-3F21	上海荣泰健康科技股份有限公司 rongtai
E3-3F31	浙江凯诗捷智能科技有限公司 Zhejiang KASJ Intelligent Technology Co., Ltd.
E3-3F71	宁波市新享科技有限公司 Ningbo Newxiang Technology Co., Ltd.
E3-3F76	深圳森选科技有限公司 Shenzhen Sun Selection Technology Co., Ltd
E3-3F81	浙江索拉卡科技有限公司 MSN
E3-3F86	浙江万陌科技有限公司
E3-3G71	杭州瑞德设计股份有限公司 Hangzhou RE&DER DESIGN Co., Ltd
E3-3G86	宁波永东电器有限公司 NINGBO YONGDONG ELECTRICAL APPLIANCE.CO,LTD
E3-3H11	深圳市千誉科技有限公司 Shenzhen Qianyu Technology Co., Ltd.
E3-3H21	蓓慈电器有限公司 Beici Electric Co., Ltd
E3-3H71	爱马斯克(深圳)科技有限公司 Imask (Shenzhen) Technology Co., Ltd.
E3-3H76	深圳市设际邹工业设计有限公司 Shenzhen ZouDesign Industrial Design Co.Lt.
E3-3H81	广东省无叶科技有限公司 Guangdong Wuye Technology Co., Ltd.
E3-3H86	浙江恒田科技有限公司

## N1 号馆 (Hall N1)

N1-1A01	宁波佳音机电科技股份有限公司 NINGBO JIAYIN ELECTRO MECHANICAL TECHNOLOGY CO.,LTD
N1-1A08	宁波开乐电机有限公司 Ningbo Calla Motor Co., Ltd.
N1-1A12	广东易得电器有限公司 Guangdong Yide Electric Appliance Co., Ltd.
N1-1A15 1A16	广东东佳实业有限公司 Guangdong Dongjia Industrial Co.,Ltd
N1-1A17 1A18	广东祥基电器有限公司
N1-1A19	广东四季福燃气具有限公司
N1-1A20	宁波易居海澳斯环保有限公司 NINGBO YIJU HAI AOSH TECHNOLOGY CO.,LTD
N1-1A21	深圳市中科世纪科技有限公司 Shenzhen Zhongke Century Technology Co., Ltd.
N1-1A22	江阴市万华金属实业有限公司 Jiangyin Wanhua Metal Industry Co., Ltd
N1-1A23	冷镜科技 (深圳) 有限公司
N1-1A24	奥美森智能装备股份有限公司 OMS MACHINERY CO.,LTD
N1-1A25	慈溪万陇电器有限公司 Cixi Wanlong Electrical Co., Ltd
N1-1A26	宁波沃丰厨卫科技有限公司 Ningbo Woofun Kitchen And Bath Technology Co., Ltd.
N1-1A27	中山天立卫厨有限公司 Zhongshan TianLi Bath&Kitchen Co.,Ltd
N1-1A28	东莞市咖伦电子有限公司
N1-1A30 1A31	广东美苏智能科技有限公司 Guangdong Meisu Electrical Appliances Co.,Ltd
N1-1A33 1A34	广东建中王电器有限公司 HENRY WANG TRAVEL MUG MANUFACTORY CO.,LTD
N1-1A36	佛山市默尔电器有限公司 Foshan Mel-tech Electrical Appliances Co Ltd.
N1-1A37	常州富鸿达电子有限公司 Changzhou FHD Electronics Co.,Ltd.

## 参展商名录 (按展馆排序) / Hall Overview

N1-1A38	宁波舜韵电子有限公司
N1-1A40	东莞动源机电科技有限公司 Dongguan Dynamic Source Mechanical And Electrical Technology Co., Ltd.
N1-1A41	瑞安市威鹏家用电器有限公司 WEIPENG
N1-1A42	佛山市安净电器有限公司 Foshan anjing electrics co., ltd
N1-1A43 1A44	宁波安芯美半导体有限公司 NINGBO ANN SEMICONDUCTOR.,LTD
N1-1A45	宁波划一马达有限公司 Ningbo Huayi Motor Co.,Ltd
N1-1A46	青岛欧亚美化学科技发展有限公司 Qingdao Eurasia-American Chemical Technology Development Co .Ltd
N1-1A47	中山市德朗迪家用电器有限公司 ZHONGSHAN DERANDI ELECTRIC APPLIANCE CO., LTD.
N1-1B01	CSA 集团 CSA Group
N1-1B06	浙江达威电子股份有限公司 Zhejiang Dawei Electronic Co., Ltd.
N1-1B10	广东德琪电器实业有限公司 Guangdong Deqi Electrical Appliance Co.,Ltd.
N1-1B15	慈溪市超宇汽车配件有限公司
N1-1B16	智晶光电股份有限公司 WiseChip Semiconductor Inc.
N1-1B17	上海冠显光电科技有限公司 Shanghai Top Display Optoelectronics Technology Co., Ltd
N1-1B18	扬州宝珠电器有限公司 Yangzhou Baozhu Electric Appliance Co. LTD
N1-1B19	佛山市顺德区环威电器有限公司 Foshan Wellway Electric Appliance Co., Ltd.
N1-1B20	杭州凡诺电子有限公司 Fannal Electronics Co.,Ltd.
N1-1B21	温州美仕贸易有限公司 Wenzhou Meishi Trading Co., Ltd
N1-1B22	胜得莱国际股份有限公司 Sandalphon International Inc.

N1-1B23	金枫林电器(无锡)有限公司 Golden Maples Electric(Wuxi) Co.,LTD
N1-1B24 1B25	北京艾斯尔科技有限公司 Beijing SR Technology Ltd.
N1-1B26	佛山市顺德区格明电器实业有限公司 Foshan geming Electric Industrial Co., Ltd
N1-1B27	广东布雷斯特电器有限公司 Guangdong Brest Electrical Appliances Co., Ltd.
N1-1B28	佛山市德嵘电器有限公司
N1-1B30	苏州朗高智能科技有限公司
N1-1B31 1A32	宁波灵鸣达电器有限公司 Ningbo Lingmingdo Electric Appliance CO.,LTD
N1-1B32 1B33 1B34	中山市艾利普电器有限公司 ZHONGSHAN AILIPU ELECTRICAL APPLIANCE CO.LTD
N1-1B35	上海一分贸易有限公司
N1-1B36	鲁班到家 LB DJ
N1-1B37	金华依娃电器有限公司 Jinhua Yiwa Electric Appliance CO., LTD
N1-1B40	广东顺德迪泰隆电器有限公司 Guangdong Shunde Detlone Electrical Appliances Co.,Ltd
N1-1B41	佛山市顺德区科霸菱电机有限公司 KBL MOTOR CO.Ltd
N1-1B42	广东升威电子制品有限公司 SOUNDWELL ELECTRONIC PRODUCTS GUANGDONG CO.,LTD
N1-1B43	广德亚蕴申橡塑有限公司 Guangde YarwinSun Rubber & Plastic CO., Ltd.
N1-1B44	台州市铭佳电器有限公司 Taizhou MAJADE Electric Appliance Co., Ltd.
N1-1B45	东莞市乔顿电子有限公司 DONGGUAN JORDUN ELECTRONIC CO.,LTD
N1-1B46	扬州爱斯派电器有限公司 Yangzhou Aspriant Electric Appliance Co. ,Ltd
N1-1B47	余姚市斯博瑞净水设备有限公司 YUYAO SPRING WATER FILTER EQUIPMENT COMPANY

N1-1C01 1C11	恒洁卫浴集团有限公司 Guangdong HEGII Sanitary Wares Co., Ltd.
N1-1C21	上海林内有限公司
N1-1C31	肖特集团平板玻璃事业部 SCHOTT AG Flat Glass
N1-1C41	杭州德意智家股份有限公司
N1-1C51	浙江奥田电器股份有限公司
N1-1C61	广东康宝电器股份有限公司 Guangdong Canbo Electrical Co.,Ltd.
N1-1C71	迅达科技集团股份有限公司 Xunda Science & Technology Group Co., Ltd.,
N1-1C81	广州市红日燃具有限公司
N1-1C86	宁波天祺科技有限公司 Ning bo Tianqi Technology Co., Ltd
N1-1D71	中山市乐喜电子科技有限公司
N1-1D76	嘉兴海格电器有限公司
N1-1E21	肖特玻璃科技(苏州)有限公司 SCHOTT Glass Technologies (Suzhou) Co., Ltd.
N1-1E81	中山市荣星电器燃具有限公司 ZHONGSHAN CITY RONGXING ELECTRIC&CAS APPLIANCE CO.,LTD.
N1-1F01	宁波方太营销有限公司 - 米博 MIBOI
N1-1F11	宁波方太厨具有限公司 Ningbo Fotile Kitchen Ware Co.,Ltd.
N1-1F41	佛山市云米电器科技有限公司 Foshan Viomi Electrical Technology Co.,Ltd.
N1-1F61	箭牌家居集团股份有限公司 Arrow Home Group Co., Ltd
N1-1F71	能率(中国)投资有限公司 NORITZ (CHINA) CO.,LTD.
N1-1F81	威能(中国)供热制冷环境技术有限公司 Vaillant Group (China) Heating, Cooling and Enviromental Technology Co., Led



## N2 号馆 (Hall N2)

N2-2A01	深圳市宝嘉智能有限公司
N2-2A10	北京贝克巴斯科技发展有限公司 Becbas(Beijing)Science&Technology Development Co.,Ltd.
N2-2A15	浙江翔龙快洁智能环保科技有限公司 Zhejiang Xianglong Fast-Clean Intelligent Enviromental Protection Technology Co.,Ltd
N2-2A16	中山市快美特电器有限公司 KUAI MEI TE
N2-2A17	杭州西蒙电器有限公司 Hangzhou Simtone Electric Co. , Ltd.
N2-2A18	普泰法尔 (廊坊) 消防科技有限公司 Protecfire (Langfang) Fire Systems Technology Co., Ltd.
N2-2A19	中山市贵宝电器有限公司 ZHONGSHAN GUIBAO ELECTRICAL APPLIANCE CO., LTD
N2-2A20	中山市鑫虎生活电器有限公司 zhongshanshixinhushenghudianqiyouxiangongsi
N2-2A21	深圳市敏杰电子科技有限公司 Shenzhen Minjie Electronics Technology Co.,LTD.
N2-2A22	慈溪叁仁电器有限公司 CIXI SANREN ELECTRICAL APPLIANCE CO.,LTD.
N2-2A23	杭州三创有机硅有限公司 HANGZHOU SICN ORGANOSILICONE CO.,LTD.
N2-2A24 2A24	宁波龙巍环境科技有限公司 Ningbo Lonwe environment technology co., LTD
N2-2A26	上海烨映微电子科技股份有限公司 Shanghai Sunshine Technologies Co., Ltd
N2-2A27	慈溪市瑞峰管业有限公司 CIXI RUIFENG PLASTIC PIPES CO., LTD.
N2-2A28	杭州倾诚工业设计有限公司
N2-2A29	浙江爱尔卡智家科技有限公司
N2-2A30	浙江百悦康科技股份有限公司 Zhejiang Beyok Technology Co., Ltd.
N2-2A31 2A32	宁波巨江电器有限公司 Ningbo Jujiang Electric Appliance Co. , Ltd.

## 参展商名录 (按展馆排序) / Hall Overview

N2-2A33 2A34	佛山市百斯特电器科技有限公司 Foshan Best Electric Appliance and Technology Co., Ltd.
N2-2A35 2A36 2A37	WPC 无线充电联盟 WIRELESS POWER CONSORTIUM, INC.
N2-2A40	广东永衡良品科技有限公司 Zhongshan Yeshm Commodities Co., Ltd.
N2-2A41 2A42	江苏航嘉电器科技有限公司 (老火际智能无烟火锅)
N2-2A43	阿索泰珂干燥剂 (上海) 有限公司 Absortech Desiccant (Shanghai) Co., Ltd.
N2-2A45 2A44	武汉亿力电子科技有限公司 Wuhan Yili Electronic Co., Ltd
N2-2A46	中山市维塔普斯电器有限公司 Zhongshan Weplus Electric Appliance Co., LTD
N2-2A47	浙江梦享家电器有限公司
N2-2A50 2A51	中山市合硕高品电器有限公司 Zhongshan SUKIO Electric Appliance CO.,Ltd
N2-2A52	东莞智城创联科技有限公司 Dongguan Zhichengchuanglian Technology Co., Ltd
N2-2A53	中山奥维斯电器有限公司 Zhongshan Always Appliance CO.,LTD
N2-2A54	佛山市顺德区酷福电器有限公司 FOSHAN SHUNDE KUFU ELECTRIC APPLIANCES CO.,LTD.
N2-2A55 2A56	江苏顺发电器有限公司
N2-2A57	深圳市黑白灰通信技术有限公司 Shenzhen Black White Grey Communication Technology Co.,Ltd.
N2-2B01	中山市宏丞玻璃科技有限公司 ZhongshanHongheGlassTechnologyCo.Ltd
N2-2B08	东莞市深鹏电子有限公司 Dongguan Shenpeng Electronics Co., Ltd
N2-2B12	广东南星玻璃有限公司 Guangdong South Star Glass Limited
N2-2B15 2B16	浙江新帝电器制造有限公司 ZHEJIANG XINDI ELECTRICAL APPLIANCES MANUFACTURING CO.,LTD.
N2-2B17 2B18 2B19	佛山市创隆电器有限公司 Foshan Get Grand Electronic Appliance Co., Ltd

N2-2B20	溧阳康达威实业有限公司 Liyang kangdawei industrial Co.,Ltd
N2-2B21 2B22	重庆市迪山科技有限公司 Chongqing Dishan Technology Co., Ltd.
N2-2B23	温州太科电子有限公司 Tecoo Electronics Co., Ltd
N2-2B24 2B25	山东亨斯特智能科技有限公司 Shandong Hesite Intelligent Technology Co., Ltd
N2-2B26	广东小将电子技术有限公司 Guangdong Xiaojiang Technology Co., Ltd.
N2-2B27 2B28	宁波易科洛捷厨电有限公司
N2-2B29	常州申嘉金属制品有限公司 CHANGZHOU SHENJIA METAL PRODUCTS CO., LTD
N2-2B30	常州光太电子科技有限公司 LIGHTBEST CO., LTD.
N2-2B31	乐清市晶瀚电子有限公司 YUEQING JINGHAN ELECTRONIC CO.,LTD
N2-2B32	佛山市鹏兴智金属制品有限公司 FOSHAN PENGXINGZHI METAL PRODUCTS CO., LTD
N2-2B33 2B34	浙江绍兴吉柏尼智能电器有限公司
N2-2B36 2B37	内蒙古三众科技有限公司 Inner Mongolia Sanzhong Technology Ltd.
N2-2B38	富乐母南京贸易有限公司 FROM Nanjing Trade Co.,Ltd
N2-2B40 2B41 2B42	浙江中讯电子有限公司 Zhejiang Zhongxun Electronics Co., Ltd
N2-2B43 2B44 2B45 2B46	江苏国唯智能机器人有限公司 Jiangsu Guowei Intelligent Robot Co. LTD
N2-2B47	宁波市塞纳电热电器有限公司 Ningbo Sunny Electrical Heating Appliances Co.,Ltd.
N2-2B50	深圳市天翔宇科技有限公司 Shenzhen Safevalue Technology Co., Ltd.
N2-2B51	中山市华尊电机有限公司
N2-2B56	中山市凯腾电器有限公司
N2-2B57	浙江商林科技股份有限公司

N2-2C01 2C11	华帝股份有限公司 Vatti Corporation Limited
N2-2C21	广东万和新电气股份有限公司 GUANGDONG VANWARD NEW ELECTRIC CO.,LTD
N2-2C51	浙江美大实业股份有限公司 Zhejiang Meida Industrial Co.,ltd
N2-2C61	杭州名气电器有限公司 HANGZHOU MQ APPLIANCES CO.,LTD.
N2-2C71	浙江森歌智能厨电股份有限公司 Zhejiang Seng Smart Kitchen Appliance Co., Ltd
N2-2C81	莱梅娜(上海)建材有限公司
N2-2E81	深圳市凯度电器有限公司 Shenzhen Casdon Electric Appliance Co., LTD.
N2-2E91	易开得净水器 IKIDE
N2-2F01 2F11	杭州老板电器股份有限公司 Robam
N2-2F41	广东万家乐燃气具有限公司 GUANGDONG MACRO GAS APPLIANCE CO.,LTD.
N2-2F51	浙江帅丰电器股份有限公司
N2-2F61	火星厨具股份有限公司 Marsessenger Kitchenware Co., Ltd.
N2-2F71	浙江亿田智能厨电股份有限公司 ZHEJIANG ENTIVE SMART KITCHEN APPLIANCE CO.,LTD.
N2-2F81	浙江美多电器有限公司 medal
N2-2F91	宁波安佳卫厨电器有限公司 Ningbo Anjia Sanitary Kitchenware & Electrical Appliance Co., Ltd.
N2-2G91	宁波美高厨具有限公司 Ningbo Mengo Kitchen Equipm
N2-2H81	广东雅丽诗电器股份有限公司 YALICE
N2-2H86	中山市海瑜生活电器有限公司 Zhongshan Haiyu Electrical Appliance Co., Ltd.

## N3 号馆 (Hall N3)

N3-3A01	浙江乐太厨具有限公司 ZHEJIANG LATIM KITCHENWARE CO.,LTD
N3-3A08	杭州向田电器有限公司
N3-3A12	宁波市小蜂电器有限公司 Ningbo Bees Electric Appliance Co.,Ltd.
N3-3A15 3A16	漳州雅宝电子股份有限公司 Zhangzhou AUPO Electronics Co.,Ltd.
N3-3A17 3A18	深圳厨艺科技有限公司 Shenzhen Chuyi Technology Co., Ltd
N3-3A19	浙江金华富朗德工贸有限公司 Fulangde
N3-3A20	江门市竞晖电器实业有限公司 JIANGMEN KINGFAI ELECTRICAL APPLIANCE IND.CO., LTD
N3-3A21 3A22 3A23	浦美泰 primitalia
N3-3A24 3A25	杭州悦味家居有限公司 Hangzhou Yuewei Household co.,ltd
N3-3A26	上海乔脉电子科技有限公司
N3-3A27	宁波新红方环保科技有限公司 Ningbo Xinhongfang Environmental Protection Technology Co., Ltd
N3-3A28	佛山顺德歌林美电子产品有限公司 Shunde Golinmate Electronic Products Co.,LTD
N3-3A30 3A31	宁波航丰电器有限公司 Ningbo Hangfeng Electric Appliance Co.,Ltd.
N3-3A32	青岛萤光创新科技有限公司
N3-3A33 3A34	芜湖艾尔达科技有限责任公司 Wuhu Aldoc Technology Co.,Ltd
N3-3A35 3A36	惠州市富进贸易有限公司 Warran
N3-3A37	中山市千寿电器有限公司 ZHONGSHAN QIANSHOU ELECTRICAL APPLIANCE CO.,LTD
N3-3A38	宁波时荣电器科技有限公司 NINGBO SUNGROY ELECTRIC APPLIANCES TECH.CO.,LTD

## 参展商名录 (按展馆排序) / Hall Overview

N3-3A39	山东一腾小家电有限公司 Shandong Yiteng Small Appliance Co.,Ltd
N3-3A40	浙江桐晟来工贸有限公司
N3-3A41	苏州伊富斯电器有限公司 Suzhou YFS Electrical Appliance Co.,Ltd
N3-3A42	中山市尼克智能科技有限公司 Zhongshan Nick Smart Technology Limited
N3-3A43 3A44	中山市快特电器有限公司 ZhongShan Kuaite Electrical Co.,Ltd.
N3-3A45	英敏特信息咨询(上海)有限公司 Mintel Group Ltd
N3-3A46	宁波美格斯特电器科技有限公司 NINGBO MEIGESITE ELECTRICAL TECH. CO.,LTD
N3-3A47	橙品科技(北京)有限公司
N3-3A48	浙江冠宝电子有限公司 ZHEJIANG GUANBAO ELECTRONIC CO., LTD.
N3-3A49	广东顺德骏特电器股份有限公司 Junte Electrical Appliances Co., ltd.
N3-3A50	中山市小明电器有限公司
N3-3A51	上海厨创妈咪实业有限公司
N3-3A52	杭州钜宜科技有限公司 Hangzhou Juyi Technology Co., Ltd
N3-3A56	中山市越好电器有限公司 Zhongshan Better Home Appliance Co., Ltd.
N3-3B01	宁波维盛电器有限公司 NINGBO VASION ELECTRIC APPLIANCE CO.,LTD.
N3-3B08	广东钻厨电器有限公司 GUANGDONG SHINECHEF ELECTRIC APPLIANCE CO.,LTD
N3-3B10	中山市博恩电器有限公司
N3-3B15	中山喜之堂电器有限公司 Zhongshan Sitom Electric Co.,Ltd
N3-3B16	宁波广旭电器有限公司 Ningbo Guangxu Electric Appliances Co.,Ltd.
N3-3B17	宁波中乐环保科技有限公司



N3-3B18	宁波曼华电器有限公司 Ningbo Manhua Electrical Appliances CO., LTD
N3-3B19	中山市康拉德电器有限公司
N3-3B20	常州绍鼎密封科技有限公司 Sealdo Technologies Corporation
N3-3B21	奥力孚传动科技股份有限公司 ONLIVE TRANSMISSION TECHNOLOGY CO.LTD
N3-3B22	威派尔(广东)电器科技有限公司 Wipfel (Guangdong) Electrical Technology Co., LTD
N3-3B23	宁波佰森厨具有限公司 NINGBO BAISHEN KITCHENWARE CO.,LTD
N3-3B24 3B25	深圳市西啡科技有限公司 Shenzhen CINO Technology Co., Ltd
N3-3B26	慈溪市高美电器有限公司 Cixi Gaomei Electric Appliance Co., Ltd.
N3-3B27	慈溪吉星电器有限公司
N3-3B28	永康市超锐电器有限公司 YONGKANG SIPPON ELECTRIC CO., LTD
N3-3B32	深圳市添美特科技有限公司 TIMIT TECHNOLOGY CO.,LTD.
N3-3B35	中山市派优宜电器有限公司 Zhongshan PUE Electric Appliance Co.,Ltd
N3-3B36 3B37	深圳市新泰合电器科技有限公司 Homer Electrical Appliances Co., Ltd
N3-3B40	东莞市泽宝智能科技有限公司 Dongguan Zestbo Intelligent Technology Co. Ltd.
N3-3B41	宁波柏森智能科技有限公司 NINGBO BAISEN INTELLIGENT TECHNOLOGY CO.,LTD
N3-3B42	广东顺德奇伟电器科技有限公司
N3-3B43	佛山市泮隐茶具有限公司
N3-3B44	中山市柏侨电器实业有限公司 Zhongshan Baiqiao Electric Industrial Co., Ltd
N3-3B45	浙江群海电子科技有限公司 Zhejiang Qunhai Electronic Technology Co., Ltd.

N3-3B46	江门美兹智能科技有限公司 Jiangmen Mielux Intelligent and Technology Co., Ltd.
N3-3B47	诺凡赛尔(上海)保护膜有限公司 Novacel (Shanghai) Co., Ltd
N3-3B50	佛山市科桦电器有限公司 Foshan Kehua Electric Appliance Co.,Ltd
N3-3B51 52	广东长锦成智能制造有限公司 Guangdong ChangJinCheng Tech Co.,LTD
N3-3B53 3B54	宁波康茂智能科技有限公司 Ningbo Konmo Intelligent Technology Co., Ltd.
N3-3B55	帕恩检测技术(杭州)有限公司 Pioneer Testing Technology (Hangzhou) Co., Ltd
N3-3B56	深圳市鼎昇电器有限公司 Shenzhen Dingsheng Electric Appliance Co., LTD.
N3-3B57	鹤山市恒富微型电机有限公司 HESHAN CITY HENGFU MICRO MOTOR CO.,LTD
N3-3C01 3C11	金牌厨柜家居科技股份有限公司 GoldenHome Living Co.,Ltd.
N3-3C21	爱仕达股份有限公司 AISHADA CO.,LTD.
N3-3C31	广东善思科技有限公司 Guangdong Soseki Tech. Ltd., Co.
N3-3C41	宜盾普(广东)智能科技有限公司 Yidunpu (Guangdong) Intelligent Technology Co., Ltd
N3-3C51	北京利仁科技股份有限公司 BEIJING LIVEN TECHNOLOGY CO.,LTD
N3-3C61	溢泰(南京)环保科技有限公司 Kemflo (Nanjing) Environmental Technology Co.,Ltd
N3-3C71	浙江山本优选智能科技有限公司
N3-3C91	深圳市宜居云科技有限公司
N3-3C95	东莞市创明电池技术有限公司 DongGuan Cham Battery Technology Co.,Ltd.
N3-3C96	浙江艾克电器有限公司 Zhejiang Aike Appliances Co., Ltd.
N3-3D71	深圳国爱全电化智能科技有限公司

N3-3D76	广东合胜集成电气有限公司 Guangdong Hesheng Integrated Electric Co.,Ltd
N3-3D81	中山市莱普帝斯电器有限公司 Zhongshan leptus Electric Appliance Co., Ltd
N3-3D86	广东鸿智智能科技股份有限公司 Guangdong Hallsmart Intelligence Technology Corporation limited
N3-3D91	广东海客堡环境科技有限公司 GUANGDONG SGH ENVIRONMENTAL TECHNOLOGY CO., LTD.
N3-3D96	广州胜维电器制造有限公司 Guangzhou Shengwei Electric Manufacturing Company Limited
N3-3E41	米技电子电器(上海)有限公司 Miji Electronics and Appliances (Shanghai) Ltd.
N3-3E51	捷赛厨电(北京)科技有限公司 Gemside Kitchen Appliances (Beijing) Co., Ltd
N3-3E61	美而浦 MULTIPURE
N3-3E71	广东三角牌电器股份有限公司
N3-3E81	铂市(上海)智能科技有限公司 JOHNBOSS(SHANGHAI) INTELLIGENT TECHNOLOGY CO.,LTD
N3-3E91	浙江优食环境科技有限公司 Zhejiang UISH Environmental Technology Co.,Ltd.
N3-3F01	上海奔泰水处理设备有限公司 Shanghai Bentai Water Treatment Equipment Co., Ltd.
N3-3F06	中山市欧博尔电器有限公司 Zhongshan Aouball Electric Appliances Co.Ltd.
N3-3F11	九阳股份有限公司 Joyoung
N3-3F21	上海乐扣乐扣贸易有限公司 SHANGHAI LOCK&LOCK TRADING CO.,LTD
N3-3F31	添可电器有限公司 TINECO
N3-3F41	广东新宝电器股份有限公司 Guangdong Xinbao Electrical Appliances Holdings Co.,Ltd
N3-3F51	悠伴 Ningbo Upany Intelligent Technology Co., Ltd

N3-3F61	广东七彩叮当智能科技有限公司 URINGO
N3-3F71	美康雅国际贸易有限公司 Conair International Trading Limited
N3-3F81	海宁市水享净水设备有限公司
N3-3F91	余姚市富达电子有限公司 YUYAO CITY FUDA ELECTRONIC CO.,LTD
N3-3G81	浙江田螺云厨科技有限公司 Zhejiang Kitchen Idea Technology Co., Ltd.
N3-3G86	广东联塑科技实业有限公司
N3-3G96	浙江炊大王炊具有限公司 zhejiang cooker king cook co.,Ltd
N3-3H21	江苏伽合电器有限公司 Jiangsu Jiahe Electric Appliance Co., Ltd
N3-3H51	宁波迈臣科技有限公司 FAGOR.S.COOP
N3-3H71	广东天际健康电器有限公司 Guangdong TONZE Health Electric Appliance Co., LTD
N3-3H76	施威朗电器(深圳)有限公司 Severin Electric Appliance (Shenzhen) Co., Ltd.
N3-3H81	深圳市帝而的客科技有限公司
N3-3H91	中山市优益电器实业有限公司 Zhongshan yoice electric appliance co ltd
N3-3H96	宁波翱尔晟电器有限公司 Ningbo Awesome Electric Appliance Co., Ltd.

## N4 号馆 (Hall N4)

N4-4A01	浙江美国科技有限公司
N4-4A06	瑞是达电子贸易(上海)有限公司 RESTAR ELECTRONICS (SHANGHAI) CO.,LTD.
N4-4A10	大同电子科技(江苏)有限公司
N4-4A15 4A16	湖州越球电机有限公司 Huzhou Yueqiu Motor Co.,Ltd.

N4-4A17	绍兴光彩显示技术有限公司 SHAOXING GUANGCAI DISPLAY TECHNOLOGY CO.,LTD
N4-4A18	无锡好力泵业有限公司 WUXI HAOLI PUMPS INDUSTRIAL CO., LTD.
N4-4A19	上海捷涌科技有限公司 Shanghai Jieyong Technology Co.,Ltd.
N4-4A20	佛山市天朋温控器有限公司 FoShan TianPeng Thermostats Co.,LTD
N4-4A21 4A22	宁波华联电子科技有限公司 NingBo Hualian Electronic Science & Technology Co.,Ltd
N4-4A23 4A24 4A25	广东奥迪威传感科技股份有限公司 Audiowell Electronics (Guangdong) Co.,Ltd.
N4-4A26	青岛大东电子有限公司 QINGDAO DADONG ELECTRONICS CO., LTD.
N4-4A27	中山市稳信电器实业有限公司 Winson Electrical Industrial Co., Ltd.
N4-4A28	中山腾威电器有限公司
N4-4A30	接格 (上海) 贸易有限公司 John Guest (Shanghai) Trading Company Ltd.
N4-4A31 4A32	苏州稼祥新材料科技有限公司 SUZHOU JIAXIANG NEW MATERIALS TECHNOLOGY CO.,LTD
N4-4A33 4A34	湖北剑威电气科技有限公司 Hubei J&V Electric Technology Co., Ltd.
N4-4A35	玛堡工业元件 (上海) 有限公司
N4-4A37	深圳市瑞比德传感技术有限公司 Shenzhen RPD Sensor Technology Co., Ltd.
N4-4A38	广东维普电器有限公司 Well Precision Inc.(USA)
N4-4A42	德国法兹全屋净水 Germany FineSky Whole House Water Purification System
N4-4A43	苏州市伟克斯电器有限公司 Suzhou Vacs Electrical Co., Ltd.
N4-4A44	北京微吼时代科技有限公司 BEIJING VHALL TECHNOLOGY CO., LTD.
N4-4A45	深圳市欧蒂诺科技有限公司 Shenzhen odnoveo technology co., ltd

N4-4A46	深圳市森普高科电子有限公司 Shenzhen SUNGPO Hi-Tech Electronic Co.,LTD
N4-4A47	深圳市星合成科技有限公司 SHENZHEN STAR SYNTHETIC TECHNOLOGY CO.,LTD
N4-4B01	惠州市宏宇高科电子有限公司 HUIZHOU CITY HONGYU HIGH-TECH ELECTRONICS CO.,LTD
N4-4B06	广东耐思菲特电气有限公司
N4-4B12-1	深圳华星恒泰泵阀有限公司 SHENZHEN CNHT COMPANY LIMITED
N4-4B12-2	深圳力干连接器有限公司 Shenzhen Power Act Connectors Enterprises Limited
N4-4B12-3	广东顺德刚辉橡胶金属制品有限公司 Guangdong Shunde Kwongfai Rubber & Metal Ltd
N4-4B12-4	星辉电业 (东莞) 有限公司
N4-4B15 4B16 4B17	青岛拓普斯智能科技有限公司 Qingdao Tuopusi Intelligent Technology Co.,Ltd.
N4-4B18	杭州洲炬电子科技有限公司 HANGZHOU ZHOJU ELECTRONIC TECHNICAL CO.,LTD
N4-4B19	东莞市联晟精密科技有限公司 Dongguan Liansheng Precision Technology Co.,Ltd
N4-4B20	江西联创南分科技有限公司 Jiangxi Lianchuang South Branch Technology Co.,Ltd.
N4-4B21	江苏艾科赛特新材料有限公司 Jiangsu Aquaset New Materials Co., Ltd.
N4-4B22 4B23	广东思利科智能科技有限公司 Guangdong Sleek Intelligent Technology Co., Ltd.
N4-4B25	广东顺德汇德隆新型材料有限公司 Guangdong Shunde Huidelong New Material Co., Ltd
N4-4B26	赣州禾盈通用零部件有限公司 Ganzhou Heying Universal Parts Co. Ltd
N4-4B27 4B28	雅各布延森设计 Jacob Jensen Design
N4-4B30 4B31	中山市越海电器有限公司 Zhongshan Yehos Electrical Appliance Co., Ltd
N4-4B32	南京海川电子有限公司 NANJING HAICHUAN ELECTRONIC CO.,LTD.



- N4-4B33 4B34 美乐家咖啡(上海)有限公司  
Melitta Coffee (Shanghai) Ltd.
- N4-4B35 上海瓦雳智能科技有限公司  
Shanghai Wali Intelligent Technology Co., Ltd
- N4-4B36 海南瑞德利晨先进科技发展有限公司  
Hainan Ruidelichen Advanced Technology Company Limited
- N4-4B37 广东凯华电器股份有限公司  
GUANGDONG KAIHUA ELECTRIC APPLIANCE CO.,LTD.
- N4-4B40 桑能实业(上海)有限公司  
SHANGHAI SUNNER INDUSTRY CO.,LTD
- N4-4B41 帝泉(上海)贸易有限公司  
Vino Fontaine Pte Ltd
- N4-4B42 深圳梵尼诗留声机有限公司  
Shenzhen fennessy phonograph Co., Ltd
- N4-4B45 4B46 浙江畅洁电子科技有限公司  
Zhejiang Changjie Electronic Technology Co.,Ltd
- N4-4B47 江苏常胜电器股份有限公司  
Jiangsu Changsheng Electric Appliance Co.,Ltd
- N4-4C01 宁波联合众投供应链管理有限公司
- N4-4C11 博西家用电器(中国)有限公司  
BSH Home Appliances (China) Co., Ltd.
- N4-4C31 博西家用电器(中国)有限公司  
BSH Home Appliances (China) Co., Ltd.
- N4-4C51 广东格兰仕集团有限公司
- N4-4C51 惠而浦(中国)股份有限公司  
Whirlpool (China) Co., Ltd
- N4-4C61 浙江爱瑞卡普田电器有限公司  
Zhejiang elica putian electric Co., Ltd
- N4-4C71 阿奇立克日立家用电器(上海)有限公司  
Arcelik Hitachi Home Appliances (Shanghai) Co., Ltd.
- N4-4C81 德格国际贸易(上海)有限公司  
Teka Int. Trading (Shanghai) Co., Ltd.
- N4-4D71 斯宝亚创(天津)电器有限公司  
STIEBEL ELTRON (Tianjin) Electric Appliance Co., Ltd.
- N4-4F01 伟视得电子贸易(上海)有限公司  
VESTEL GROUP

- N4-4F11 松下家电(中国)有限公司  
Panasonic Appliances (China) Co., Ltd
- N4-4F31 伊莱克斯(中国)电器有限公司  
Electrolux (China) Home Appliance Co., Ltd.
- N4-4F61 4F71 美诺电器有限公司
- N4-4F81 阿兰斯洗涤设备(广州)有限公司  
Alliance Laundry Equipment (Guangzhou) Ltd
- N4-4F81 北京爵士汇商贸有限公司  
BEIJING FRESHWAY TRADING CO., LTD.
- N4-4F81 博塔桑尼(北京)厨房设备有限公司  
Bertazzoni (Beijing) Kitchen Appliances Co., Ltd.
- N4-4F81 利勃海尔(中国)有限公司  
Liebherr (China) Co., Ltd.

## N5 号馆 (Hall N5)

- N5 海尔智家股份有限公司  
Haier Smart Home Co., Ltd.

## W1 号馆 (Hall W1)

- W1-1A01 宁波乐士实业有限公司  
Ningbo Lesli Group Co.,LTD
- W1-1A04 TÜV 南德意志大中华集团  
Greater China
- W1-1A05 宁波划一马达有限公司  
Ningbo Huayi Motor Co.,Ltd
- W1-1A06 东莞市诚润电子科技有限公司  
DONG GUAN CHEVRON ELECTRONIC TECHNOLOGY CO,LTD
- W1-1A10 1A11 宁波翔荣精密模具有限公司  
Ningbo Xiangrong Precision Mold Co., Ltd
- W1-1A12 上品健康科技(广东)股份有限公司  
Topg Health Technology(Guang Dong)Co.,Ltd
- W1-1A13 浙江佰航电器有限公司  
ZHEJIANG BAIHANG ELECTRICAL APPLIANCE CO.,LTD
- W1-1A14 佛山市楼氏电子科技有限公司  
Foshan Loushi Electronic Technology Co., Ltd

W1-1A15	深圳市莱特兄弟科技有限公司 Shenzhen Wright Brothers Technology Co.,LTD
W1-1A16 1A17	深圳市三利达电器科技有限公司 Shenzhen Sanliida Electrical Technology Co., Ltd
W1-1A20	杭州士兰微电子股份有限公司 HANGZHOU SILAN MICROELECTRONICS CO., LTD
W1-1A25 1A26	广州市台博自动化设备有限公司 Guangzhou TaiBo Automatic Equipment Co.,Ltd
W1-1A40	深圳市顺章电器有限公司 Shenzhen Sunzone Electrical Appliances Ltd
W1-1A41	徐州通用高新磁电有限公司 Xuzhou general hi tech magnetoelectric Co., Ltd
W1-1A42 1A43	清洋流体科技(上海)有限公司 Cinyar Fluid Technology (Shanghai) Co., Ltd
W1-1A44	广州银冠温控器有限公司
W1-1A45	东莞市宏源净化设备有限公司 Dongguan Hongyuan Purification Equipment Co., Ltd.
W1-1A46	好利来(厦门)电路保护科技有限公司 Hollyland (Xiamen) Technology Corporation Limited
W1-1A47	宁波市海曙德瑞斯标识有限公司
W1-1A50	佛山美立三维科技有限公司 Trio Industrial Solutions
W1-1A51 1A52	广州海科电子科技有限公司 Guangzhou Haike Electronics Technology Co., Ltd
W1-1A53 1A54	江苏安惠医疗器械有限公司
W1-1A55 1A56	青岛沃尔特赫恩电子科技有限公司 QINGDAO WALTERHEEN ELECTROIRC TECHNOLOGY CO.LTD
W1-1A57	温州高巨标牌有限公司 Wenzhou Gaoju Sign Co.,Ltd.
W1-1B01	东莞市精锋智能玻璃有限公司 Dongguan Jimfuk Smart Glass Company Limited
W1-1B02	宁波海燕新材料有限公司 Ningbo Haiyan New Material Co.,Ltd.
W1-1B05	宁波顺和电子科技有限公司 Ningbo Shunhe Electronic Technology Co., LTD

W1-1B06	浙江正科电机有限公司
W1-1B10	江门吕泉记五金制品厂 LUI CHUEN KEE (JIANGMEN) METAL MANUFACTORY
W1-1B11	深圳市施威德自动化科技有限公司 Shenzhen SWIFT Automation Technology Co.,Ltd.
W1-1B12	昆山荣逸自动化设备有限公司
W1-1B13 1B14	深圳市爱博绿环保科技有限公司
W1-1B15	东莞市宝人电器科技有限公司
W1-1B20	东莞市耀和玻璃有限公司 Dongguan Yaohe Glass Co.,Ltd
W1-1B21	东莞厚博精密塑胶科技有限公司
W1-1B22	宁波宝亿德电器有限公司 ningboBalyideElectricApplianceCoLtd
W1-1B23	深圳市创启达科技开发有限公司 Shenzhen CQD Technology Development Co.,LTD
W1-1B24	佛山万马电子科技有限公司 Foshan Wanma Electronic Technology Co., LTD
W1-1B25	爱芯环保科技(厦门)股份有限公司
W1-1B26	深圳市构通科技有限公司 Gotong technology
W1-1B27	慈溪市天勤电器有限公司
W1-1B30	广东程视视觉科技股份有限公司 CHANCE3D
W1-1B40	深圳市森威尔科技开发股份有限公司 SHENZHEN SASWELL TECHNOLOGY INC.
W1-1B41	北京海研自动化科技有限公司
W1-1B42	广东固特科技有限公司
W1-1B43	圣戈班高性能塑料(上海)有限公司 Saint-Gobain Performance Plastics(Shanghai) Co., Ltd.
W1-1B44	深圳市普晟传感技术有限公司 ProSense Technologies Co., Ltd.
W1-1B45	宁波美煜电器有限公司 Ningbo Meiyu Electrical Appliance Co., Ltd.

W1-1B46	宁波夏康电器科技有限公司 NINGBO XIANKANG ELECTRICAL TECHNOLOGY CO.,LTD
W1-1B47	东莞市能博旺动力科技有限公司 DongGuan Nengbowang Power Technology Co.,Ltd.
W1-1B50	宁波宁蒸铝业有限公司 NINGBO NINGZHENG ALUMINUM INDUSTRY CO., LTD
W1-1B51	村田 (中国) 投资有限公司 Murata
W1-1B52	江苏华频电子科技有限公司 JIANGSU HOPRIO ELECTRONIC TECHNOLOGY CO.,LTD
W1-1B53	东莞慧迪智能科技有限公司 Dongguan Huidi Intelligent Technology Co.,Ltd
W1-1B54	广州市泰亨电子电器有限公司 GUANGZHOU TAIHENG ELECTRIC APPLIANCE CO., LTD
W1-1B55	宁波瑞狄安采暖科技有限公司 Ningbo Edeans Heating SYSTEMS Manufacturing Co., Ltd.
W1-1B56	惠州三华工业有限公司 HUIZHOU SANHUA INDUSTRIAL CO.,LTD
W1-1C11 1C31	北京京东世纪贸易有限公司
W1-1C51	江苏双鹿电器有限公司 Jiangsu SONLU Electric Appliance Co. , Ltd.
W1-1C61	佛山开彩科技有限公司
W1-1C66	苏州平云机电科技有限公司 PBM Motor and Fan (Suzhou) Co., Ltd
W1-1C71	东莞市旭恒电子有限公司 Dongguan Xuheng Electronics Co., Ltd
W1-1C76	海速芯 (杭州) 科技有限公司 Hitenx(Hangzhou)Technology Co.,Ltd
W1-1C81	美国国际铜专业协会上海代表处 International Copper Association
W1-1C91	苏州瑞禾信息科技有限公司 SUZHOU RUHE INFORMATION TECHNOLOGY CO.,LTD.
W1-1C92	江苏伟恒玻璃制造有限公司 Jiangsu Weiheng Glass Manufacturing Co.,Ltd
W1-1C93	成都派斯光科技有限公司 CHENGDU PULSE OPTICS-TECH CO.,LTD

W1-1C94	东莞市精联精密技术有限公司 Dongguan Jeolink Precision Technology Co.,Ltd
W1-1C95	东莞劲佳精密部件有限公司 Dongguan Jinjia Precision Parts Co., Ltd
W1-1C96 1C97	魔芯 (湖州) 科技有限公司 Moxin (Huzhou) Tech. Co., Ltd
W1-1C98	中山市知新玻璃科技有限公司 Zhong Shan Zhi Zin Glass Technology
W1-1D81	浙江银升新材料有限公司 ZHEJIANG YINSHENG NEW MATERIALS CO.,LTD.
W1-1D86	友贸电机 (深圳) 有限公司 Nichibo Motor(Shenzhen) Co.,Ltd
W1-1D91	红品晶英科技 (深圳) 有限公司 Hongpin Jingying Technology (Shenzhen) Co., Ltd.
W1-1D96	科泰模型科技 (苏州) 有限公司 COMOTEC (Suzhou) CORPORATION
W1-1D97	佛山市臻运制冷科技有限公司 Foshan Zhenyun Refrigeration Technology Co., Ltd.
W1-1D98	开平威镪电器有限公司
W1-1D99	苏州市沃旗电器有限公司 Suzhou Woqi Electric Appliance Co.,Ltd
W1-1E61	浙江中广电器集团股份有限公司 ZHEJIANG ZHONGGUANG ELECTRIC Co.,Ltd.
W1-1E81	尼得科全球电器 Nidec Global Appliance
W1-1F01 1F11 1F31 1F51 1F71	TCL 实业控股股份有限公司 TCL Industrial Holdings CO., LTD.

## W2 号馆 (Hall W2)

W2-2A01 2A02	广州亨龙智能装备股份有限公司 Heron Intelligent Equipment Co.,Ltd
W2-2A03	河源市信大石英电气有限公司 HeYuan XinDa quartz electric appliance Co.,Ltd.
W2-2A08	江苏雷利电机股份有限公司



W2-2A10	深圳市唯真电机发展有限公司 Shenzhen Weizhen Motor Development Co., Ltd
W2-2A11	苏州瑞泰克散热科技有限公司 JINAN RETEK INDUSTRIES INC
W2-2A12	浙江亿宝科技有限公司 ZHEJIANG YIBAO TECHNOLOY CO.,LTD
W2-2A13	东莞市本末科技有限公司 directdrivetech
W2-2A14	宁波轩畅电器有限公司 NINGBO XUANCHANG ELECTRIC CO.,LTD
W2-2A15	浙江大安电子科技有限公司 Zhejiang Daan Electronic Technology Co., Ltd.
W2-2A20 2A21	无锡中微爱芯电子有限公司 WUXI I-CORE ELECTRONICS CO., LTD
W2-2A22	深圳市蓝巨科技有限公司 SHENZHEN RAYSR TECH CO., LTD.
W2-2A23 2A24	中山市汇德温控器有限公司 Zhongshan Huide Thermostat Co., Ltd.
W2-2A25 2A26 2A27	瑞孚化工(上海)有限公司 Shrieve Chemical (Shanghai) Ltd
W2-2A30 2A31	东南电子股份有限公司 DONGNAN ELECTRONICS CO.,LTD
W2-2A32	佛山市九龙机器有限公司 Foshan city Jiulong Machinery Co., LTD
W2-2A33 2A34 2A35	兰溪市越强电器有限公司 LANXI YUEQIANG ELECTRICALAPPLIANCES CO.,LTD
W2-2A36	广州市聚赛龙工程塑料股份有限公司 SUPER-DRAGON ENGINEERING PLASTICS CO.,LTD
W2-2A37	上海肃菲电子科技有限公司 ShangHai SUP Electronic Technology CO., LTD
W2-2A40	无锡伏尔康科技有限公司 WUXI VULKAN Technologies Co., Ltd.
W2-2A41 2A42	慈溪久盈电器有限公司 CIXI JIUYING ELECTRICAL CO.,LTD.
W2-2A43	广东中宝温控科技股份有限公司 Guangdong Zhongbao Thermostat Technology Co., Ltd.

W2-2A44	广州安的电子技术有限公司 Safty Electronic Technology Co.,Limited
W2-2A45	东莞金坤新材料股份有限公司 Dongguan Jiconn New Material Holdings Co.,LTD
W2-2A46	佛山卢国辉电器实业有限公司 Foshan Luguohui Electric Industrial Co.,Ltd
W2-2A47	宁波市顺泰电器有限公司 NINGBO SUNTA ELECTRICAL APPLIANCE CO., LTD
W2-2B01	福建赛特新材股份有限公司 Fujian Supertech Advanced Material Co., Ltd.
W2-2B02	东莞市福恩电子有限公司 DONGGUAN FUEN ELECTRONICS CO.,LTD.
W2-2B03	深圳市永诚创科技有限公司 Shenzhen YCCFAN Technology Co.,Ltd.
W2-2B04	浙江蜂鸟新材料有限公司
W2-2B06 2B05	四川迈科隆真空新材料有限公司 Sichuan Micolon Vacuum New Material Co.,Ltd.
W2-2B10 2B11	佛山市川东磁电股份有限公司 Chuangdong Magnetic Electronics Co., Ltd.
W2-2B12	常州五王电机有限公司 Changzhou W&W Motor Co., Ltd.
W2-2B13	裕克施乐塑料制品(太仓)有限公司
W2-2B20 2B21 2B22 2B23	江苏百乐电器有限公司 Jiangsu
W2-2B24 2B25	慈溪市时代模具有限公司 CIXI SHIDAI MOULD CO.,LTD
W2-2B26	浙江百润轴承有限公司 ZheJiang Baron Bearing Co.,Ltd
W2-2B27	浙江易豪电子有限公司 ZHEJIANG YIHOO ELECTRIC CO., LTD
W2-2B30 2B31	宁波乐美佳电器科技有限公司 Ningbo Lemeijia Electric Equipment Technology Co.,Ltd
W2-2B32	广东雄润电业有限公司 Guangdong Xiongrun Electrical Co., Ltd.

W2-2B33 2B34	四方光电股份有限公司 2B35 2B36 Cubic Sensor and Instrument Co., Ltd.
W2-2B37	东莞市明盛电气有限公司   深圳市迈尔盛绝缘材料有限公司 DONGGUAN MYSUN ELECTRIC CO., LTD /SHENZHEN MYSUN INSULATION MATERIALS CO., LTD
W2-2B40	宁波铭瑞中兴电子科技有限公司 Ningbo Mingrui Zhongxing Electronic Technology Co., Ltd.
W2-2B41	中山市华尼斯电子有限公司 Zhongshan Huanisi Electronic co., Ltd
W2-2B42	中山市众安温控器有限公司 Zhongshan Zhongan temperature controller Co., Ltd
W2-2B43	苏州工业园区建维薄膜开关厂 Jianwei Membrane Switch
W2-2B44	江门市双杰电机有限公司 JiangMen SOJOTECH Motor Co., LTD.
W2-2B45	乐清市厦华电子有限公司
W2-2B46	广州恒星传导科技股份有限公司 HANSTAR WIRE AND CABLE TECHNOLOGY CO., LTD
W2-2B47	东莞市狮徕电子有限公司 DongGuan KingLion Electronics Co.,Ltd
W2-2C01	珠海格力电器股份有限公司 Gree Electric Appliances Inc. of Zhuhai
W2-2C11 2C31	珠海格力电器股份有限公司 Gree Electric Appliances, Inc. Of Zhuhai
W2-2C51	中山市一匠科技有限公司 ZhongshanYijiang Technology Co.,Ltd.
W2-2C61	厦门呼博仕智能健康科技股份有限公司 Xiamen BRI Environmental Industry Co.,Ltd.
W2-2C71	宁波灭霸康美科技有限公司 NINGBO MBV KANGMEI TECHNOLOGY CO.,LTD
W2-2C81	杭州星帅尔电器股份有限公司 Hangzhou Star Shuaier Electric Appliance Co., Ltd.
W2-2D51	宁波乐开宝电器有限公司 LUCKBOIL
W2-2D61	慈溪市夏蒙电器有限公司 CIXI CITY SHAR MOON ELECTRIC CO.,LTD.

W2-2D66	宁波鼎安电器有限公司 NINGBO DINGAN ELECTRIC APPLIANCE CO., LTD
W2-2D71	广东思诺得环保科技有限公司 Guangdong Cinotex Environmental Sci-Tech Co., Ltd.
W2-2D76	東洋桑工業科技(上海)有限公司 Toyosan Industrial Technology (Shanghai) Co., Ltd
W2-2D81	黄石东贝压缩机有限公司 Huangshi Donper Compressor Co., Ltd
W2-2E51	深圳市康弘智能健康科技股份有限公司 HEALTHLEAD COPORATION LIMITED
W2-2E61	广州东奥电气有限公司 Guangzhou Dongao electrical Co., Ltd.
W2-2E71	广东英为拓科技有限公司 Guangdong Invitop Technology Co., Ltd.
W2-2E81	杭州钱江制冷压缩机集团有限公司 Hangzhou Qianjiang Refrigeration Compressor Group Co.,Ltd.
W2-2F01	上海海立电器有限公司 Shanghai Highly Electrical Appliances Co., Ltd
W2-2F11	奥克斯空调股份有限公司 AUX
W2-2F31	广东奥马冰箱有限公司 Homa Appliances Co., Ltd.
W2-2F41	澳柯玛股份有限公司 AUCMA CO., LTD
W2-2F51	宁波德业日用电器科技有限公司
W2-2F61	舒乐氏 SoleusAir
W2-2F71	广东多乐信电器有限公司 DOROSIN
W2-2F81	加西贝拉压缩机有限公司 JIAXIPERA COMPRESSOR CO.,LTD.
W2-2G51	上海哈克过滤科技股份有限公司 Hawk Filtration Technology(Shanghai) Co.,Ltd
W2-2G61	青岛瑞智机电销售有限公司 Qingdao Rechi Electric Machinery Sales Co., Ltd.
W2-2G71	依哥智慧家居有限公司

W2-2G76	安徽乐金环境科技有限公司 LEKING
W2-2G81	常熟市天银机电股份有限公司
W2-2H51	宁波天瑞智能科技股份有限公司
W2-2H61	深圳市英维克健康环境科技有限公司 Shenzhen Envicool Health Environment Technology Co.,Ltd.
W2-2H71	青岛朗兹环保科技有限公司 Qingdao Londs Environmental Protection Technology Co., LTD.
W2-2H76	江苏黑森林环保科技有限公司 SCHWARZWALD TECH CO.LTD
W2-2H81	扎努西电气机械天津压缩机有限公司 Zanussi Elettromeccanica Tianjin Compressor Co.,Ltd

### W3 号馆 (Hall W3)

W3-3A01	宁波普尔机电制造有限公司 Ningbo Puer Mechanical Electrical Manufacturing Co.,Ltd.
W3-3A08	厦门市拙雅工业设计有限公司 Xia Men Joyatech Co.,Ltd.
W3-3A10 3A11	厦门赛尔特电子有限公司 Xiamen SET Electronics Co., Ltd.
W3-3A12	广东米德加德电器科技有限公司 GuangDong Midgard Electrical Appliance Co.,Ltd
W3-3A13	无锡芯感智半导体有限公司 Wuxi Sencoch Semiconductor Co.,Ltd
W3-3A14	巨福五金塑料(深圳)有限公司 GALFORD HARDWARES&PLASTIC (SHENZHEN) CO.,LTD
W3-3A15	东莞市凡睿电子科技有限公司 DONGGUAN FAN RUI ELECTRONICS & TECHNOLOGY CO.LTD
W3-3A20 3A21	上海永星电子开关有限公司 SHANGHAI YONGXING ELECTRONIC SWITCH CO.,LTD.
W3-3A22	广东捷容科技有限公司 Guangdong Jierong Technology Co., Ltd
W3-3A23	浙江弗里斯检测技术有限公司 Zhejiang Fries Testing Technology Co.,Ltd.

W3-3A24	台州威锦贸易有限公司 Taizhou Weijin Trade Co.,Ltd
W3-3A25	中山市汇贤智控科技有限公司
W3-3A26 3A27	中山拓飞电器科技有限公司
W3-3A30	长沙博安通软件科技有限公司 Changsha B&T Software Technology Co., Ltd.
W3-3A31	广东华九新材料科技有限公司 Guangdong Huajiu New Material Technology Co., Ltd.
W3-3A32	东莞龙基电子有限公司 longkey electronic(Dongguan) co.,ltd
W3-3A33 3A34	深圳市发掘科技有限公司 Discovery Technology(SHENZHEN) Co.LTD
W3-3A35	深圳市壹洁智能科技有限公司 Shenzhen ONEJ Technology Co., Ltd.
W3-3A36 3A37	广州奥松电子股份有限公司 Guangzhou Aosong Electronic Co., Ltd.
W3-3A40	浙江红星电业有限公司 ZHEJIANG HONGXING ELECTRICAL CO., LTD
W3-3A41 3A42	深圳市德诚旺科技有限公司 Shenzhen Dechengwang Technology Co., Ltd.
W3-3A43	无锡市万力粘材料股份有限公司
W3-3A44	中山市升平热保护器有限公司 ZHONGSHAN SHENG PING THERMAL PROTECTORS CO.,LTC
W3-3A45	山东正能电池有限公司 Shandong Zhengneng Battery Co. LTD
W3-3A46	上海牙酷牙碧科技有限公司 aquapick technology co.,ltd.
W3-3A47	深圳市云中飞电子有限公司 VVFLY Electronics Co., Ltd.
W3-3B01	镇江东方电热科技股份有限公司
W3-3B08	中山市力泰电子工业有限公司 Zhong Shan City Li Tai Electronic Industrial Co., Ltd
W3-3B10	宠米科技 & 上品设计 & 凡辉设计 MIPet&TOP Design&Fanhui Design



W3-3B11	杭州宇树科技 Unitree Robotics
W3-3B12	天长市泽创电子科技有限公司 TIANCHANG TRUMPPX ELECTRONIC TECHNOLOGY CO LTD
W3-3B13	苏州慧闻纳米科技有限公司 Suzhou Huiwen Nano S&T Co.,Ltd.
W3-3B14	浙江途康家居用品有限公司 ZHEJIANG IHOMEY HOUSEWARE CO., LTD
W3-3B15	深圳市天正达电子股份有限公司 Shenzhen Tianzhengda Electronics Co., LTD.
W3-3B20	浙江康尔乐电子有限公司
W3-3B21	依云智酷(北京)科技有限公司
W3-3B22	江阴佩尔科技有限公司 PEIERTECH
W3-3B23	杭州家吉宝科技有限公司
W3-3B24	南京欣威视通信息科技股份有限公司 Nanjing Signway Technology Co.,Ltd.
W3-3B25	廊坊瑞地新材料科技有限公司 Langfang Ruidi New Material Technology Co., Ltd.
W3-3B26	胜业电气股份有限公司 Sheng Ye Electric Co.,Ltd
W3-3B27	乐清市心牌电子科技有限公司 Yueqing city heart technology Co., Ltd.
W3-3B30	深圳市壹海智能有限公司 Shenzhen Yaohai Intelligent Co., Ltd
W3-3B31	广东顺德凝卓智能科技有限公司 Guangdong Shunde ningzhuo Intelligent Technology Co., Ltd
W3-3B32	乐磁电子有限公司
W3-3B33 3B34	江苏中信华电子科技有限公司 Jiansu Zhongxinhua EElectronics Co Ltd
W3-3B35 3B36	广云物联网科技(广州)有限公司 Granwin IoT Technology (Guang zhou) Co., Ltd
W3-3B37	广东天洋电机有限公司
W3-3B40 3B39	北京探境科技有限公司 Intengine Technology Co.,Ltd.

W3-3B41 3B42	四川千里倍益康医疗科技股份有限公司
W3-3B43 3B44	广东惠利普智能科技股份有限公司 Guangdong Huilipu Intelligent Technology Co., Ltd
W3-3B46	上海欣日科技股份有限公司 SHANGHAI YOUNG SUN SCIENCE&TECHNOLOGY CO.,LTD
W3-3C01	甄十信息科技(上海)有限公司 Zhenshi Information Technology (Shanghai) Company Limited
W3-3C11	康佳集团股份有限公司 KONKA Group Co., Ltd.
W3-3C51	德心智能科技(常州)有限公司 Definition Smart Technology (Changzhou) Co.,Ltd
W3-3C61	中山市众扬电器有限公司 Zhongshan City PeoFly Electric Co.,Ltd.
W3-3C62 3C63 3C64	湖州南洋电机有限公司 HUZHOU NANYANG ELECTRIC-MOTOR CO.,LTD
W3-3C65 3C66 3C67	三友联众集团股份有限公司 Sanyou Lianzhong Corporation Limited
W3-3C68	广东华声电器实业有限公司
W3-3C71	上海小燕科技有限公司
W3-3C76	上海庆科信息技术有限公司 Shanghai MXCHIP Information Technology Co., Ltd.
W3-3C100	山东圣阳锂电新能源有限公司
W3-3C106	一微半导体 Amicro
W3-3C110 3C111	中山市曼诺施电器有限公司
W3-3C112	宁波比爱她智能科技有限公司 Ningbo BAT-X Intelligent Technology Co., Ltd
W3-3C113	赛趋科软件(上海)有限公司 Centric Software (Shanghai) Co.,Ltd
W3-3C114	中山市胡博士电器科技有限公司
W3-3C115 3C116	慈溪市恒马电器科技有限公司
W3-3C117	杭州艾达普智能科技有限公司 Hangzhou Adaprox Intelligent Technology Co., Ltd.

W3-3C118 3C119	相與科技(上海)有限公司 Shanutec
W3-3D61	苏州索图智能物流设备有限公司
W3-3D66	安徽聆思智能科技有限公司
W3-3D110 3D111	上海迪勤智能科技有限公司 DST TECHNOLOGY
W3-3D112	艾尔玛科技股份有限公司 IMR Technology Co., LTD.
W3-3D113 3D114	武汉高德智感科技有限公司 Wuhan Guide Sensmart Tech Co.,Ltd
W3-3D115	宁波万事达综研电气有限公司 NINGBO MASTER SOKEN ELECTRICAL CO.LTD.
W3-3D116	宁波绿之品电器科技有限公司 NINGBO LVZHIPIN ELECTRICAL APPLIANCE SCIENCE AND TECHNOLOGY CO.,LTD.
W3-3D117	佛山市华满诚拓家居用品有限公司
W3-3D118	中山市南歌电子制造有限公司 Zhongshan Nange Electronic Manufacturing Co., LTD
W3-3D119	武汉灵途传感科技有限公司 WUHAN LINGTU SENSOR TECHNOLOGY CO.LTD
W3-3E01	杭州华橙网络科技有限公司 Hangzhou Huacheng Network Technology Co.,Ltd
W3-3E51	安徽扬子空调股份有限公司 Anhui Yangzi Air Conditioning Co., Ltd
W3-3E61	佛山市国星光电股份有限公司 FOSHAN NATIONSTAR OPTOELECTRONICS CO.,LTD
W3-3E71	思必驰科技股份有限公司 AI Speech Co., Ltd.
W3-3E81	杭州涂鸦信息技术有限公司 HangZhou Tuya Information Technology CO., LTD
W3-3E91	广州飒特红外股份有限公司 Guangzhou SAT Infrared Technology Co., Ltd.
W3-3E111	武汉优炜芯科技有限公司 WUHAN UVLEDTEK CO,LTD
W3-3F01	昆山怡口净水系统有限公司

W3-3F11	西屋电气公司 Westinghouse Electric Corporation
W3-3F31	山东小鸭控股集团有限公司 SHANDONG XIAOYA HOLDING GROUP CO., LTD
W3-3F41	橙色云互联网设计有限公司 Uniorange Internet Design Co., Ltd.
W3-3F71	科大讯飞股份有限公司 iFLYTEK CO., LTD.
W3-3F81	深圳市力合微电子股份有限公司 Leaguer MicroElectronics Corp.
W3-3F91	上海梦百合家居科技有限公司 SHANGHAI MLILY BEDDINGS CO., LTD.
W3-3F100	浙江聚倍科技集团股份有限公司 Zhejiang Jubei Technology Group Co., Ltd.
W3-3H41	汉王科技股份有限公司
W3-3H70	上海极音网络科技有限公司 Shengwang
W3-3H71	河南福申电子科技有限公司 Henan Fosen Electronics Technology Co., Ltd.
W3-3H72 3H73	佛山市顺德区欧开威电器有限公司 Foshan City Shunde District Oukaiwei Electric Appliance Co., Ltd.
W3-3H74	乐清市嘉信科技有限公司 YueQing Jiaxin Technology Co.,Ltd.
W3-3H75	广东德通电线有限公司 Guangdong Detong Electric Wire & Cable Co., Ltd.
W3-3H76	宁波莱悦电器有限公司 Ningbo Laiyue Electric Appliance Co., Ltd.
W3-3H81	中国船舶集团有限公司第七一八研究所 The 718th research institute of csic
W3-3H86	深圳市勤毅尚品电子有限公司
W3-3H87	东莞市欧斯凯健身器材科技有限公司 Dongguan Osky Fitness Equipment Co., Ltd
W3-3H88 3H89	佛山市诺伊达电器实业有限公司
W3-3H90	广东中健医疗器械有限公司

W3-3H91	深圳市集创兴科技有限公司 Shenzhen TCS Precision Technology Co.,Ltd
W3-3H92	湖南航天磁电有限责任公司 HUNAN AEROSPACE MAGNET & MAGNETO CO.,LTD.
W3-3H93	宁波胜航电器有限公司 Ningbo Shenghang Electric Appliance Co., Ltd.
W3-3H94	深圳市菲比斯科技有限公司 PROTECH INTERNATIONAL GROUP CO., LI
W3-3H95 3H96	苏州雪雁科技有限公司 Suzhou SnomGoose Technology Co.,Ltd
W3-3H97	浙江千云锂电气科技有限公司 Zhejiang Qianyunli Electric Technology Co.,LTD
W3-3H98	上海宝松包装材料有限公司 Shanghai Pouson Packing Material Co.,Ltd.
W3-3H99	中山市连想电器有限公司 ZHONGSHAN LIANXIANG ELECTRICAL APPLIANCE CO.,LTD
W3-3H111	精英汇信息科技(青岛)有限公司 Elitehui Information Technology Company

## W4 号馆 (Hall W4)

W4-4A01	上海侨亨实业有限公司
W4-4A08	广东美智智能科技有限公司 GUANGDONG MEZIC TECH.,LTD
W4-4A10 4A11	深圳市盈源电子有限公司 Shenzhen shi Yingyuan Electronics Co.,Ltd
W4-4A12	上海宸宫国际贸易有限公司 Dream innovative future corporation
W4-4A13	博流智能科技(南京)有限公司 Bouffalo Lab (Nanjing) Co.,Ltd
W4-4A14	上海志承新材料有限公司 SHANGHAI ZHICHENG NEW MATERIAL CO.,LTD
W4-4A15	东莞智信五金制品有限公司 DONGGUAN ZHIXIN METALLIC PRODUCTS CO., LTD.
W4-4A20 4A21	Vayyar

W4-4A22	深圳市三赢为电子科技有限公司 SANWIN ELECTRONIC TECHNOLOGY CO.,LTD
W4-4A23	浙江佳华精化股份有限公司 Zhejiang Java Specialty Chemical Co.,Ltd
W4-4A24	深圳市将帅科技有限公司 Shenzhen General Technology Co., Ltd
W4-4A25	江苏日成橡胶有限公司 Jiangsu Richeng Rubber Co., Ltd
W4-4A26 4A27	南京三头牛电子科技有限公司 Nanjing SANTNEW Tech Ltd
W4-4A30	中山市华塑塑胶科技有限公司 Zhongshan Huasu Plastics Technology Co.,Ltd
W4-4A31	上海华舍集良智能科技有限公司 Shanghai Hua She Ji Liang Intelligent Science and Technology Co., Ltd
W4-4A32	深圳市蓝宝安科电子有限公司 Shenzhen lanbao Anke Electronics Co., Ltd
W4-4A33 4A34	中山市乖致电器科技有限公司 Zhongshan City Guaizhi Electrical Technology Co., Ltd
W4-4A35	上海芯美电子科技有限公司 Shanghai Xinmei Electronic Technology Co.,Ltd.
W4-4A36	中山市域森电器有限公司 Zhongshan Yusen Electrical Co., LTD
W4-4A37	佛山市广源兴电子有限公司 Foshan Guangyuanxing Electronics Co., Ltd
W4-4A38	珠海市奥斯陆新材料有限公司 ZHUHAI OSLO NEW MATERIAL CO., LTD
W4-4A40	佛山御小兔科技有限公司 Foshan Ubunnys Technology Co., Ltd.
W4-4A41 4A42	杭州光粒科技有限公司 Hangzhou Guangli Technology Co., Ltd.
W4-4A50	东莞市东颂电子有限公司 DONGGUAN DONGSONG ELECTRONIC CO., LTD
W4-4A51	宁波市善纶电器有限公司 Ningbo Shanlun Electric Appliance Co.,Ltd
W4-4A52	余姚市天猫电器有限公司



W4-4A53	上海姿东智能科技有限公司 Shanghai Zidong Technology Co., Ltd.
W4-4A55	湖州乐通电子科技有限公司 Huzhou Lotto Electronic Technology Limited
W4-4A56	江西亨成实业有限公司 Jiangxi Hengcheng Industrial Co., Ltd
W4-4A57	上海迪捷通数字科技有限公司 Shanghai Digiotech Technology Co., Ltd
W4-4B01	环驰轴承集团有限公司 Huanchi Bearing Group Co., Ltd
W4-4B08	浙江达峰科技有限公司 Zhejiang Dafeng Technology Co., LTD
W4-4B10	上海嘉矿科技有限公司 XVGATE
W4-4B11	极电光能有限公司
W4-4B12	佛山市顺德区伊默特电机有限公司 FOSHAN SHUNDE E-MOTOR CO.,LTD.
W4-4B13	深圳市美思先端电子有限公司 Shenzhen MFrontier Electronics Co.,Ltd.
W4-4B14	宁波德茨工业科技有限公司 NINGBO TEXZE INDUSTRIAL TECHNOLOGY CO., LTD
W4-4B15	GapGun (China) & PPS
W4-4B20	仕达利恩(惠州)电子有限公司 STARION (H.Z)ELECTRONICS CO.,LTD
W4-4B21	通城县大鑫智能传感科技有限公司 Tongcheng Daxin Intelligent Sensor Technology Co.,Ltd.
W4-4B22	库贝化学(上海)有限公司 Kuberd Chemicals (Shanghai) Co.,Ltd
W4-4B23 4B24	温州市铭源标牌有限公司 WenZhou City Mingyuan Sign Co.,Ltd
W4-4B25	福州三立电子有限公司 FUZHOU SWELL ELECTRONIC CO., LTD
W4-4B26	广东丘比尔实业有限公司 GUANGDONG QBILL INDUSTRIAL CO.,LTD.
W4-4B27	深圳市冒险岛工业设计有限公司 MAOOXD

W4-4B30 4B31	东莞市铱鑫电子科技有限公司
W4-4B32	青岛杰生电气有限公司 Qingdao Jason Electric Co., Ltd.
W4-4B33 4B34	澳汰尔工程软件(上海)有限公司 Altair Engineering Software (Shanghai), Ltd.
W4-4B35	东莞市成东电子科技有限公司 THE DONGGUAN CHENGDONG ELECTRONIC TECHNOLOGY CO., LTD
W4-4B36	广东众能物联科技有限公司
W4-4B37	深圳市雅贝康科技有限公司 ShenzhenYabeikangTechnologyCo.,Ltd
W4-4B38	宁波佳迈智能科技有限公司 Ningbo Ubetter Intelligent Technology Co.,Ltd.
W4-4B39	深圳市欢创科技有限公司 Shenzhen Camsense Technology Co., Ltd.)
W4-4B40	科尤特软件(上海)有限公司 Qt Group
W4-4B41	上海熠速信息技术有限公司 Shanghai YISU Information Technologies Co.,Ltd.
W4-4B42	福州格麟机电技术有限公司 Fuzhou Green Mechanical and Electrical Technology Co.,LTD
W4-4B43	云帆瑞达科技(深圳)有限公司 Micradar Technology (Shenzhen) Co., LTD
W4-4B44	深圳市优奕视界有限公司 SHENZHEN VIEWE TECHNOLOGY CO.LTD
W4-4B47	上海印梦智能科技有限公司 Shanghai Prindream Intelligent Technology Co.,Ltd.
W4-4B50	宁波应拓科技有限公司 Ningbo Inventor Technology Co., Ltd.
W4-4B52	中山市稳升电器有限公司 Zhongshan Wensheng Electric Appliance Co., Ltd
W4-4B53	广州市远威实业有限公司 Triumphy Electronics Co., Ltd
W4-4B54	浙江柔星科技有限公司
W4-4B55 4B56	广东梵吉尼科技有限公司

W4-4B57	温州市爱哈标牌有限公司 Wenzhou AiHan sign Co., LTD.
W4-4C81	深圳市科力尔运动控制技术有限公司 Shenzhen Keli Motion Control Technology Ltd.
W4-4C86	广州机智云物联网科技有限公司 Guangzhou Gizwits IoT Technology Co., Ltd.
W4-4D80	上海炉石信息科技有限公司 Loostone
W4-4D81	广州金升阳科技有限公司 MORNSUN Guangzhou Science & Technology Co., Ltd.
W4-4D86	深圳乐动机器人股份有限公司 SHENZHEN LDROBOT CO.,LTD
W4-4E01	中关村在线 ZOL
W4-4E11	北京森博明德营销管理顾问股份有限公司 Cenbo Marketing
W4-4E21	夏普科技(深圳)有限公司 Sharp Tech (Shenzhen) Co., Ltd
W4-4E31	索尼(中国有限公司) Sony (China) Ltd
W4-4E51 4E71	创维集团有限公司 Skyworth Group Co.,Ltd
W4-4E81	凤凰光学股份有限公司 Phenix Optics Co.,Ltd.
W4-4F01	杭州金松优诺电器有限公司 Hangzhou Jinsong EUNA Electrical Appliances Co.,Ltd
W4-4F11	华为终端有限公司 Huawei Device Co., Ltd.
W4-4F31 4H51	三星(中国)投资有限公司 SAMSUNG (CHINA) INVESTMENT CO., LIMITED
W4-4F61	六安索伊电器制造有限公司 Lu'an Soyea ElectricL Manufacturing Co., Ltd.
W4-4F71	深圳市佳简几何工业设计有限公司 Shenzhen XIVO Design Co., Ltd.
W4-4F81	瑞昱半导体 Realtek Semiconductor Corp.

W4-4G71	广东瑞德智能科技股份有限公司 Guangdong Real-Design Intelligent Technology Co., Ltd.
W4-4G81	深圳市韶音科技有限公司 Shenzhen Shokz Co., Ltd.
W4-4G86	东莞市徕芬电子科技有限公司 Dongguan Laifen Electronic Technology Co., Ltd.
W4-4H01	江苏达伦电子股份有限公司 Jiangsu Dalen Electronics Co., Ltd.
W4-4H61	江西格林循环产业股份有限公司 Jiangxi Green Recycling Co.,Ltd.
W4-4H66	广州鹏辉能源科技股份有限公司 Guangzhou Great Power Energy & Technology CO., LTD.
W4-4H71	嘉兴劲峰智能科技有限公司 Jia Xing King-Top Intelligent Tech . Ltd
W4-4H76	深圳市启明云端科技有限公司 Wireless-Tag Technology Co., Ltd.
W4-4H86	中山市卓杰奥电器有限公司
W5-5A01 5A02 5A03	南南铝业股份有限公司
W5-5A04	昆山王子过滤制品有限公司 KunShan Oji Filter Co.,Ltd
W5-5A05	上海华工艾马尔新材料有限公司 Shanghai Huagong Amar New Material Co.,Ltd
W5-5A06	汉洋(博罗)电子有限公司 Han Yang (Boluo) Electronics Ltd.
W5-5A10	慈溪市兴泓电器有限公司
W5-5A11	上海御牧贸易有限公司 MIMAKI
W5-5A12	南京熊猫电子制造有限公司 Nanjing Panda Electronics Manufacturing Co.,Ltd.
W5-5A13 5A14	长沙多浦乐泵业科技有限公司 TOPS Industry and Technology CO., Ltd
W5-5A15	法诺设计 FONU
W5-5A20	佛山市南海区松岗东华田金属制品厂 Foshan Nanhai District Songgang Donghuan Metal Products Factory

W5-5A21	广州市狮霸电器制造有限公司 Guangzhou siber Electric Mfg. Ltd
W5-5A22	宁波杉君电器有限公司
W5-5A23 5A24	慈溪市众邦电器有限公司 CIXI ZHONGBANG ELECTRIC APPLIANCE CO.,LTD.
W5-5A25	佛山市顺德区飞湃科技有限公司 FoShan ShunDe Feipai Technology Co. Ltd.
W5-5A26	厦门科司特电子工业有限公司 Xiamen Castec Electronic Industry Co., Ltd.
W5-5A27	深圳市好运达电器有限公司 Shenzhen Luckystar Electrical CO., LTD.
W5-5A30	佛山市通宝华通控制器有限公司 Foshan Tongbao-Huatong Controls Co., Ltd.
W5-5A32	华祥检测机构 Ningbo HATEK Co., Ltd
W5-5A33	上海家用电器行业协会
W5-5A36	广东天物新材料科技有限公司
W5-5A37	芜湖华族环境技术股份有限公司
W5-5A40	东莞市国研电热材料有限公司 Key Material Co.,Ltd.
W5-5A41	浙江清越科技有限公司 PeroPure.Inc
W5-5A42	浙江佳龙电子有限公司 Zhejiang Jialong Electron Co.,Ltd
W5-5A43	苏州八爪鱼机器人有限公司
W5-5A46 5A45 5A44	中山雅岚电器有限公司 Artair International Co., Ltd.
W5-5A47	广东酷宁电器科技有限公司
W5-5B01	佛山市顺德区恒维电子科技有限公司 Kingway (Foshan) Electronic Technology Co.Ltd
W5-5B03 5B04	深圳市安拓浦科技有限公司 SHENZHEN ANTOP TECHNOLOGY CO., LTD
W5-5B05	北京与光科技有限公司 Beijing Seetrum Technology Co., Ltd.

W5-5B06	鉴衡巍德谊(浙江)检测认证有限公司 VDE CGC (Zhejiang) Testing and Certification Co., Ltd.
W5-5B10 5B11	东莞航电新能源科技有限公司 Dongguan Hangdian New Energy Technology Co.,Ltd
W5-5B12	佛山市顺德区通昊电器有限公司 FOSHAN SHUNDE MAXCAN ELECTRICAL APPLIANCES CO.,LTD
W5-5B13	中山市洁鼎过滤制品有限公司 J&D Activated Carbon Filter Co.,Ltd.
W5-5B15 5B14	浙江探享家智能科技有限公司
W5-5B20	捷和环境科技(深圳)有限公司 Chiaphua Environmental Technology (Shenzhen) Co.,Ltd
W5-5B21	苏州苏大维格科技集团股份有限公司 SVG tech Group
W5-5B22	深圳市佰太科技有限公司 SHENZHEN BAITAI TECHNOLOGIES CO. LTD.
W5-5B23 5B23 5B24	浙江欣轮(智能科技)集团
W5-5B25	广州市微生物研究所集团股份有限公司 Guangzhou Institute of Microbiology Group Co., Ltd.
W5-5B26 5B27	深圳朝典科技有限公司
W5-5B30 5B31	宁波飞芯电子科技有限公司 Ningbo ABAX Sensing Electronic Technology Co., Ltd.
W5-5B32 5B33 5B34 5B35	广东天骏智能科技有限公司 Guangdong Tjump Intelligent Technology Appliance co., LTD
W5-5B36 5B37	上海捷宝金属集团有限公司 Shanghai Jiebao Metal Group Co., Ltd
W5-5B40	厚联环境科技(上海)有限公司 Holarn Enviromental Technology
W5-5B41	江苏瓦恩新材料科技有限公司 Jiangsu Waen New Material Technology Co., Ltd
W5-5B42	宁波欧胜电器有限公司 NINGBO OUSHENG ELECTRIC CO.,LTD.
W5-5B43	上海松山电子有限公司 Shanghai Songshan Electronics Co., Ltd.
W5-5B44	青岛鸿博新能源有限公司 Qingdao Hongbo New Energy Co.,Ltd.



W5-5B45	浙江致广科技有限公司 ZheJiang ZhiGuang Technology CO.,LTD
W5-5B46	湖南正申科技有限公司 HUNAN ZENNZE TECHNOLOGY LIMITED
W5-5B47	宁波波康照明电器有限公司 NINGBO UCOME LIGHTING CO., LTD.
W5-5C11 5B02	四川长虹电器股份有限公司 Sichuan Changhong Electric Co.,Ltd
W5-5C31	广州万宝家电控股有限公司 Guangzhou Wanbao Household Electric Appliances Holding Co., Ltd.
W5-5C41	3M 中国有限公司 3M China limited
W5-5C51	永林电子股份有限公司 Y.LIN ELECTRONICS.,LTD.
W5-5C61 5C62	浙江鹏孚隆新材料有限公司 Zhejiang Pfluon New Materials Co., Ltd.
W5-5C63	宁波杰世米电器有限公司 NINGBO JASMINE ELECTRICAL APPLIANCE CO., LTD
W5-5C64	东莞市奇光电子有限公司 DONGGUAN SPAR ELECTRONISC CO., LTD.
W5-5C65	中山市博安泰电器科技有限公司 Zhongshan boantai electric technology co., ltd
W5-5C66	佛山市欧亿电器有限公司 FoShan OE Electrical Appliance Co., Ltd.
W5-5C67 5C68	深圳市甲由设计顾问机构有限公司 Jaudesign Agency
W5-5C71	肇庆晟辉电子科技有限公司
W5-5C81	深圳市东芯电控技术有限公司 Shenzhen Dongxin Electric Control Technology Co., Ltd
W5-5C82	上海三间维科技有限公司 Shanghai Sanjianwei Technology Company LTD.
W5-5C83	思微自控科技(乐清)有限公司 iSwell AutoControl Technology (Yueqing) Co., Ltd.
W5-5C85	九霄鹿 airdeer

W5-5C86	中山市迪高诺电器科技发展有限公司
W5-5D51	浙江多迪斯泰保健器材有限公司 Zhejiang Dotast Healthcare Equipment Co.,Ltd
W5-5D71	东莞市银泰丰光学科技有限公司 Yin Tai Feng(Dong Guan City)Optical Technology Co.,Ltd.
W5-5D81	上海环世物流(集团)有限公司 Worldwide logistics Group
W5-5D86	苏州益而益电器制造有限公司 ELEGRP
W5-5E41	美芝 & 威灵 GMCC&Welling
W5-5E51	广东哈士奇制冷科技股份有限公司 HCK Refrigeration Tech.,Inc
W5-5E61	安徽万朗磁塑股份有限公司 ANHUI HIGASKET PLASTICS CO.,LTD
W5-5E71	德国库尔兹集团 KURZ GROUP
W5-5E81	江苏稳润光电有限公司 Jiangsu Wenrun Optoelectronic Co., Ltd.
W5-5E86	四川丹甫环境科技有限公司 Sichuan Danfu Environment Technology Co.,Ltd
W5-5F01 5F11 5F31 5F51 5F71	海信集团控股股份有限公司 Hisense

# AWE 2023

APPLIANCE&ELECTRONICS  
WORLD EXPO

中国家电及消费电子博览会

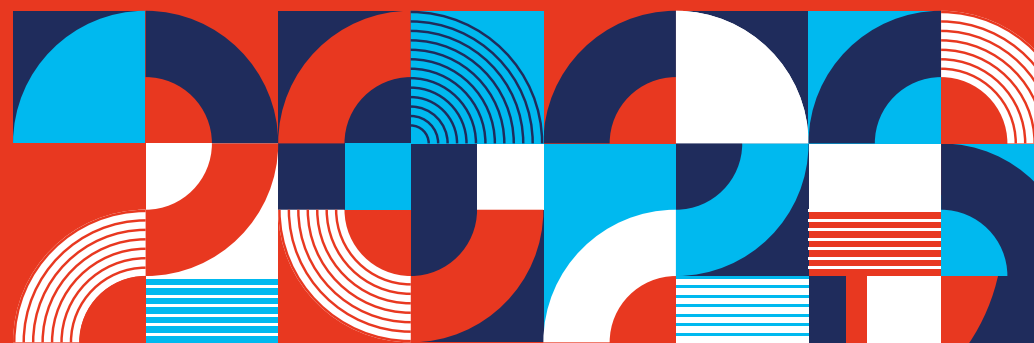

参展商名录 (按展馆排序)

Hall Overview

**参展商名录** (按字母排序)

Alphabetical List of Exhibitors

中山市家用电器行业协会，成立于2008年9月，由本市从事家用电器研制、开发生产、技术推广应用等单位自愿组成的，具有社团法人资格的全市家用电器行业协会，是地方性、行业性、非营利性的社会团体。协会致力于为全市家电企业传递行业资讯，组织商贸洽谈，搭建融资平台，开展活动交流，拓展产品市场，提供政策指导等全方面服务，是连接企业和政府之间的重要桥梁。中山市家用电器行业协会依托中山市家电创新中心公共技术平台，为企业提供工业设计、产品研发、检测认证、计量监检、技术培训、信息服务、法律服务、专利商标、知识产权、进出口服务等，为构建国内外经济双循环发展新格局，加快中山家电现代化产业体系建设，助推行业高质量发展贡献力量！

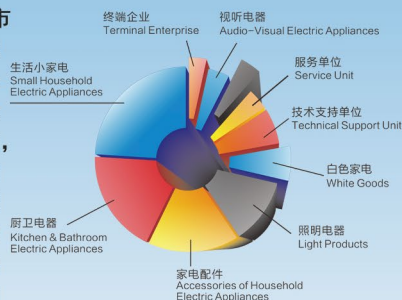

Zhongshan Household Electrical Appliances Association, founded in September, 2008, is made up of voluntary units specialize in a wide range of fields such as research, development and production, and technical promotion and application in terms of household electric appliances. The municipal association, which is a local, industry-based and non-profit social organization, possesses the qualification of Aggregate Corporation. It devotes to overall services like transferring industry information to local household electric appliance enterprises, organizing business negotiation, establishing financing platform, carrying out activities and exchanges, expanding product market and providing policy guidance, and has been considered as an important bridge which connects enterprises and government. The association relies on the public technology platform of the Household Electric Appliances Innovation Center, providing industrial design, product development, testing and certification, measurement and supervisory inspection, technical training, information services, legal services, patents and trademarks, intellectual property rights and import and export services. In order to build a new pattern of double cycle development of domestic and foreign economy, accelerate the construction of modern industrial system of Zhongshan household appliances, and boost the high-quality development of the industry!

**联系方式**

联系人：霍先生、罗小姐、刘小姐  
电话：0760-22519221、22519223、22519228  
邮箱：zsjdxh@163.com  
网站：www.zsjdxh.org  
地址：广东省中山市南头镇南头大道中59号三楼



**3M 中国有限公司**  
**3M China limited**

**W5-5C41**

地址：上海市虹桥开发区兴义路8号万都中心38楼 (200336)  
Add: 3M China, 38/F, Maxdo Center, 8 Xing Yi Rd, Shanghai  
电话 /Tel: 86-21-62753535  
传真 /Fax: 86-21-62752343  
网址 /Web: <https://www.3m.com.cn/>

3M 公司创建于 1902 年，全球总部位于美国明尼苏达州的圣保罗市。作为一家世界领先的多元化科技创新企业，3M 的产品和技术早已深深地融入人们的生活。100 多年以来，3M 开发了六万多种产品，从家庭用品到医疗产品，从运输、建筑到商业、教育和电子、通信等各个领域。3M 中国于 1984 年 11 月在中国注册成立，是在深圳经济特区外成立的中国第一家外商独资企业。

Founded in 1902, 3M is headquartered in St. Paul, Minnesota, USA. As a world-leading innovative corporation, 3M has developed a wide range of technologies and products that improve our daily lives. Total more than 60,000 high-quality products over the course of 100plus years, 3M's products range from household to healthcare, from transportation, construction to business, education, electronics and telecommunication, and so on. Registered in China in November 1984, 3M China was the first wholly foreign-invested enterprise established outside the Shenzhen Special Economic Zone. As one of the first foreign-invested enterprises registered in China, 3M China has achieved rapid growth over the past 30 years, in tune with the rhythm of China's economic development.

主要展品 /Products  
胶带和胶粘剂  
Tape and Adhesive



**CSA 集团**  
**CSA Group**

**N1-1B01**

地址：广东省广州市黄埔区科研路10号 (510663)  
Add: 10 Keyan Rd., Huangpu District, Guangzhou, China.  
电话 /Tel: 86-20-87320648  
传真 /Fax: 86-20-87320306  
网址 /Web: [www.csagroup.org](http://www.csagroup.org)

CSA 集团成立于 1919 年，是国际公认的标准开发、测试与认证权威机构，目前在北美、欧洲、亚太等地均设有办事机构。CSA 集团传承百年经验，是您可信赖的国际合作伙伴。我们早年间为铁路开发标准，时至今日，我们随着技术更迭不断与时俱进，始终秉持为最前沿的科学技术制定标准，并开发相应的测试与认证服务。我们拥有众多资质，坚持以人为本，从而可为客户提供定制化的测试、认证解决方案，助力您前瞻标准，远瞩未来。

Founded in 1919, CSA Group is a global organization dedicated to safety, social good and sustainability. We are a leader in Standards Development and in Testing, Inspection and





Certification around the world including Canada, the U.S., Europe and Asia. Rely on an internationally recognized company with over 100 years of expertise and knowledge. From our early beginnings developing standards for railway, bridges to today's latest sustainable technologies, we're always looking forward and developing innovative standards and testing programs for the most advanced and emerging technologies. Drawing on our industry accreditations, our customer-focused experts can create custom solutions that meet your unique testing, inspection, and certification needs. That's how we're holding the future to a higher standard.

#### 主要展品 /Products

我们可以提供的产品包括:

燃气具测试与认证;  
暖通产品测试与认证  
智能卫浴及水处理测试与认证  
功能安排评估与认证  
GMA 全球市场准入及多国认证

We can test and certify the following products:

Gas appliance  
HVAC/R  
Smart appliance  
Plumbing products  
Functional safety  
Global Market Access



#### GapGun (China) & PPS

W4-4B15

地址: 深圳福田区园岭街道华林社区八卦三路八卦岭工业区 423 栋 509,11-13 (518029)

电话 /Tel: 0755-82267222

传真 /Fax: 0755-82267333

网址 /Web: www.supertooling.com

“高精达”始于 1976 年,四十多年至今,不懈致力为中国制造业提供世界前沿测量产品和转移高新测量技术,包括精密计量工具、特殊应用传感器、精密加工耗材和技术等,业务涵盖航空航天、汽车工业、医疗康复、消费电子产品等。

高精达提供突破性的“触感测量”传感器和设计方案,让人手触感得以数字化。从诊断的科技化到产品手感的量化,高精达为医疗及康复行业带来崭新的产品开发手段和开拓传统 TCM 的科技化产品。

#### 主要展品 /Products

TactileHead 耳机触感分布测试仪  
TactileHead

## JOOSUNG

### JOOSUNG

E1-1E86

地址: 浙江省慈溪高新技术产业开发区新兴一路

电话 /Tel: 0574-63403925

JOOSUNG 成立于 2020 年,位于浙江省宁波市,是一家以从事电气机械和器材制造业为主的企业,集研发、生产、销售于一体的国家高新技术企业,主营小家电产品,产品出口至全球 40 多个国家和地区,ODM/OEM 出口销量稳居前列,在国内主流电商平台和线下商超等铺设销售渠道。

#### 主要展品 /Products

小家电



### TCL 实业控股股份有限公司

W1-1F01 1F11 1F31 1F51 1F71

### TCL Industrial Holdings CO., LTD.

地址: 惠州仲恺高新区惠风三路 17 号 TCL 科技大厦 22 层 (516001)

Add: 22nd Floor, TCL Technology Building, No.17 Huifeng Third Road,  
Zhongkai High-tech Zone, Huizhou

电话 /Tel: 18928440486

传真 /Fax: 0752-2278018

网址 /Web: www.tcl.com

TCL 创立于 1981 年,前身为中国首批合资企业之一——TTK 家庭电器(惠州)有限公司,从最初从事磁带的生产制造到布局电话、电视、手机、冰箱、洗衣机、空调、液晶面板等领域,业务范围不断拓展。

2019 年, TCL 拆分为 TCL 科技集团股份有限公司(简称“TCL 科技”)和 TCL 实业控股股份有限公司(简称“TCL 实业”)。至今业务遍及全球 160 多个国家和地区,成长为具有全球影响力的领先企业。

TCL was established in 1981 as TTK Home Appliances (Huizhou) Co., Ltd., and was one of China's first joint venture companies. It started with producing magnetic tape and eventually moved on to produce telephones, televisions, mobile phones, refrigerators, washing machines, air conditioners, LCD display panels, etc., and its scope of business is constantly expanding. In 2019, TCL completed the handover of major assets in a restructuring and was split into TCL Technology Group Corporation (TCL Technology) and TCL Industrial Holdings (TCL Industrials). TCL Technology focuses on the semi-conductor display and materials industry and is supported by industrial finance & investment business and venture capital investment to accelerate its transformation into a technology & capital-intensive high tech industrial group. As of today, TCL operates in over 160 countries and regions around the world. It has grown to become a leading company with global influence.

#### 主要展品 /Products

TCL 从最初从事磁带的生产制造到布局电话、电视、手机、冰箱、洗衣机、空调、液晶面板等领域,业务范围不断拓展。2019 年, TCL 完成资产重组,拆分为 TCL 科技集团股份有限公司(简称“TCL 科技”)和 TCL 实业控股股份有限公司(简称“TCL 实业”)。TCL 科技聚焦半导体显示及材料产业,以产业金融与投资创投支持主业发展,加速向技术/资本密集型的高科技产业集团转型。



TCL started with producing magnetic tape and eventually moved on to produce telephones, televisions, mobile phones, refrigerators, washing machines, air conditioners, LCD display panels, etc., and its scope of business is constantly expanding. In 2019, TCL completed the handover of major assets in a restructuring and was split into TCL Technology Group Corporation (TCL Technology) and TCL Industrial Holdings (TCL Industrials). TCL Technology focuses on the semi-conductor display and materials industry and is supported by industrial finance & investment business and venture capital investment to accelerate its transformation into a technology & capital-intensive high tech industrial group.



**TÜV 南德意志大中华集团  
Greater China**

**W1-1A04**

地址: 上海市恒通路 151 号  
电话 /Tel: 021-61410123  
网址 /Web: www.tuvsud.cn

TÜV 南德意志集团成立于 1866 年, 前身为蒸汽锅炉检验协会。发展至今, 已成为了全球化的机构。TÜV 南德意志集团在 50 个国家设立了 1,000 多个分支机构, 拥有 25,000 多名员工, 致力于不断地提高自身的技术、体系及专业知识。集团的技术专家在工业 4.0、自动驾驶及可再生能源的安全与可靠性方面均作出了显著的技术创新。

**主要展品 /Products**

家用和商用大家电认证服务  
智能家电产品网络安全测评服务  
China Mark 认证标志



**Vayyar**

**W4-4A20 4A21**

地址: 江苏省苏州市苏州工业园区时代广场 24 栋 A 座 3 楼 (215021)  
电话 /Tel: 13771706727  
传真 /Fax: 0519-85866616  
网址 /Web: www.vayyar.com.cn

Vayyar 是一家专注于毫米波高分辨率射频成像技术的以色列高科技公司, 其研发的片上射频成像传感系统, 可以在保护隐私的前提下, 采集重要的生命数据, 为智能家居、长者照护、交通出行、智能零售、安检安防等领域提供解决方案。

Vayyar 致力于研发更先进、更小型、性价比更高及用途更广泛的传感技术, 关注每个人的生活, 进而打造一个更加智能、安全、和谐的社会。

Vayyar, the leader in 4D imaging radar, supplies the world's most advanced radar-on-chip platforms and multilayered software to gather life's essential data, providing solutions for sectors including senior care, automotive, retail, security, medical, and robotics.

Vayyar's mission is to deliver the next generation of sensing technology that is miniature, affordable, and versatile enough to impact everyone's lives, enabling a safer world.

**主要展品 /Products**

Vayyar 射频成像模组, 是一种新型的基于无线电射频传感技术的“智能摄像头”, 在火柴盒大小的尺寸上集成了高达 46 根收发天线, 通过一片自研的高集成度片上射频系统芯片 VYYR7201 驱动, 可提供几十倍于传统雷达的分辨率, 实现存在检测、人体跟踪、跌倒姿态、生命体征检测等高级探测应用。该模组将芯片、DSP 处理器、天线和算法集成在一起, 可帮助客户克服复杂性, 快速进行评估和开发, 加速产品上市。

**WIRELESS POWER**

**CONSORTIUM**

**WPC 无线充电联盟  
WIRELESS POWER CONSORTIUM, INC.**

**N2-2A35 2A36 2A37**

地址: 美国新泽西州, WPC c/o ISTO, 445 Hoes Lane, Piscataway,  
Add: WPC c/o ISTO, 445 Hoes Lane, Piscataway, NJ 08854, USA  
电话 /Tel: 0017324655843  
网址 /Web: www.wirelesspowerconsortium.com

WPC 无线充电联盟是世界领先的无线充电标准化组织, 为消费者、零售商和制造商提供通用、可互操作的无线充电设备标准和认证。通过严格的测试和认证, 这家全球机构致力确保无线充电和无线电源的安全性、高效性和互操作性。WPC 无线充电联盟全球的近 300 家会员单位制定并使用了现行的 Qi 标准, 同时也正在开发 Ki 无线厨房、轻型电动车、和工业机器人等标准来支持无线充电的创新应用。

The Wireless Power Consortium leads the world in ensuring consumers, retailers and manufacturers that they can rely on universal, interoperable standards and certifications for wireless devices. Through rigorous testing and certifications, the global body is dedicated to ensuring safe, efficient, and interoperable wireless charging and wireless power. The WPC's more than 300 member organizations established and support the current Qi standard and are developing standards for innovative new applications of wireless power including the Ki Cordless Kitchen, LEV and Industry.

**主要展品 /Products**

Qi 标准, Ki 标准, 轻型电动车无线充电标准, 工业机器无线充电人标准。  
Qi standard, Ki standard, LEV, Industry standards.

# airapex

阿尔卡司

阿尔卡司(成都)空气净化技术有限公司

E2-2G86

地址: 四川省成都市高新区益州大道北段布鲁明顿 A 座 402 (610000)

电话 /Tel: 028-88451919

传真 /Fax: 028-88451919

airapex 阿尔卡司

阿尔卡司是全球领先的空气健康与安全领域的创新型科技公司。阿尔卡司自研“水体门控”空气净化技术,运用多层复合 HEPA 滤芯 +T 形水洗净化滤芯的空气净化方式,能够一次性将空气中的物理性污染物质、化学性污染物质、生物性污染物质,一体化治理完成。旨在为您创造,更好的空气,更好的生活。

主要展品 /Products

T7pro 水洗空气净化器

R8 空气消毒净化机器人



阿兰斯洗涤设备(广州)有限公司

N4-4F81

Alliance Laundry Equipment (Guangzhou) Ltd

地址: 中国广东广州市荔湾区龙溪中路 48 号之二 (510378)

Add: No.48-2 Longxizhong Road, Liwan District, Guangzhou 510378, China

电话 /Tel: +86 (020) 8141 5566

阿兰斯洗衣设备公司始于 1908 年,总部设于美国,是享誉全球的商用洗衣设备生产商和服务供应商。作为全球商用洗衣领域的全球领导者,Alliance 拥有市场上最广泛和完整的产品系列,旗下知名品牌包括: Speed Queen、UniMac、Primus、Huebsch 和 IPSO,生产各类型洗衣机、烘干机和熨烫设备。其设备广泛应用于专业洗衣房,自助洗衣,公寓式洗衣,家用洗衣等多种领域,服务于如酒店、洗衣工厂、自助洗衣房、学校、医院、物业、餐馆、家用、军营、消防等几乎所有行业。

Established in 1908 and with headquarters in Wisconsin, Alliance Laundry Systems LLC is the largest commercial laundry equipment company in the world. As the world leader in commercial laundry, Alliance offers the widest, most complete range of laundry products and solutions, which are distributed under the brands and Speed Queen, UniMac, Primus, Huebsch and IPSO. Widest range and reach to serve the demands of on-premises laundry, vended, multi-housing and home laundries, our products are popular with all industries such as Hospitality, Healthcare, Laundromat, Multi-housing, Facilities, Restaurants, Home, Marine, and Fire etc..

主要展品 /Products

产品涵盖各类型商用洗衣机、烘干机、熨烫机以及高端家用洗衣机、烘干机及衣物护理柜等,容量从 10Kg-200Kg 全系列。

Products cover all types of commercial washers, dryers, ironing machines and high-end home washers, dryers and laundry care cabinets, with capacities ranging from 10Kg-200Kg.

# HITACHI

阿奇立克日立家用电器(上海)有限公司

N4-4C71

Arcelik Hitachi Home Appliances (Shanghai) Co., Ltd.

地址: 中国(上海)自由贸易试验区金湘路 1100 号 (201206)

电话 /Tel: 008602151782188

传真 /Fax: 51782100

网址 /Web: <https://www.hitachi-homeappliances.com.cn/>

阿奇立克日立家用电器(上海)有限公司是 Arçelik Hitachi Home Appliances 在中国市场的下属企业。

其中 Arçelik Hitachi Home Appliances 成立于 2021 年 7 月 1 日,是 Arçelik 与 Hitachi Global Life Solutions, Inc. 的合资企业, Arçelik Hitachi Home Appliances was established on July 1st, 2021 as a joint venture between Arçelik and Hitachi Global Life Solutions, Inc.

主要展品 /Products

在全球范围内生产、销售冰箱、洗衣机、吸尘器日立品牌家电并提供售后服务(日本市场以外)。

To manufacture, sell and provide after-sales services of Hitachi branded home appliances including refrigerators, washing machines, vacuum cleaners globally (outside of the Japanese market).



阿索泰珂干燥剂(上海)有限公司

N2-2A43

Absortech Desiccant (Shanghai) Co., Ltd.

地址: 闵行区顾戴路 2337 号维璟中心 B 栋 12 层 B2C1 单元 (201199)

Add: B2C1, Building B, #2337 Gudai Road, Minhang District, Shanghai

电话 /Tel: 021-67681621

传真 /Fax: 021-67681622

网址 /Web: [www.absortech.com](http://www.absortech.com)

Absortech 公司潜心专注于帮助全球客户避免潮湿货损。自 1996 年以来,我们开发了 AbsorRange 系列干燥剂产品,我们为集装箱内、包装袋内以及家用环境提供创新的防潮保护技术。从用户的产品开发、制造、运输的全过程进行把控,确保在正确的地点交付高品质的干燥剂产品。公司拥有丰富的解决方案,帮助客户控制潮湿货损相关问题。我司集装箱干燥剂系列已经全部实现了碳中和,助力客户实现供应链减碳目标。

Ever since we were founded in Sweden in 1996, we have been driven by innovation. Initially, by developing desiccants based on calcium chloride as the absorbing agent. Recently, and increasingly important, we have developed a toolbox of services outlining which measures to take to prevent moisture damage. Correct use of desiccants reduces the environmental impact as a result of decreased scrapping or questionable pre- or re-work. What's more, most of our products in AbsorRange™ are now CO2-neutral. The calculations are 3rd party validated and the unavoidable CO2 is offset via Gold Standard-certified projects.

Today, Absortech is a truly global company. This means we can offer our products from seven



Absortech locations or via our global network of partners and distributors. Furthermore, a solid solution requires being present at both the departure and the arrival harbors, and this makes us the ideal partner for larger corporations.

#### 主要展品 /Products

AbsorGel Hanging  
AbsorGel Blanket  
AbsorGel Max  
AbsorGel Pouch  
AbsorGel Hanging  
AbsorGel Blanket  
AbsorGel Max  
AbsorGel Pouch

## IDEEDO

艾迪宝

艾迪宝科技  
IDEEDO

E1-1H21

地址：深圳市龙华区龙华街道油松社区黄贝岭靖轩工业园7栋4层 (518000)

Add: Floor 4, Building 7, Jingxuan Industrial Park, Huangbeiling, Longhua District, Shenzhen

电话 /Tel: 075523779283

传真 /Fax: 075523779283

网址 /Web: <https://www.ideedo.com/>

IDEEDO 艾迪宝是一家专注于以创新科技提升消费者家庭幸福感的创新公司。倡导“化繁为简 轻松爱家”的理念。以成为智能家庭清洁的优质国民品牌作为前进动力。艾迪宝深耕高端生活电器领域，主打家居智能清洁电器、环境电器等产品，致力于为消费者改善居家生活环境，提升用户家庭生活品质。艾迪宝洗地机等产品上市后即深受广大用户赞誉。

IDEEDO is an innovative company focusing on improving consumers' family happiness with innovative technologies. Advocate the concept of "simplify and love your family". To become the intelligent household cleaning quality national brand as the driving force. Aidibao is deeply engaged in the field of high-end household appliances, focusing on intelligent household cleaning appliances, environmental appliances and other products, and is committed to improving the home living environment for consumers and enhancing the quality of family life. Aidibao washing machine and other products after the market is praised by the majority of users.

#### 主要展品 /Products

艾迪宝 T60、艾迪宝 T70、艾迪宝 T80、艾迪宝 V50 PRO  
ideedoT60、ideedoT70、ideedoT80、ideedoV50 PRO



艾尔玛科技股份有限公司  
IMR Technology Co., LTD.

W3-3D112

地址：东莞市长安镇广安路5号

Add: No. 5 Guang'an Road, Chang'an Town, Dongguan City

电话 /Tel: 0769-39009111

网址 /Web: [www.imr.cc](http://www.imr.cc)

艾尔玛科技股份有限公司 (IMR)，提供卓越的智能表面装饰方案，塑造美好生活；专注 IMS 工艺整体配套，IMR 转写箔、专用注塑模具开发与研究，已成为众多世界 500 强企业的战略合作伙伴。

公司安全运营 17 年 +，于全球 7 个国家的 16 个地区设立生产基地及分支机构；公司占地面积超过 20000m<sup>2</sup>，拥有现代化无尘生产车间、恒温恒湿量测室，配备欧、美、日进口高端专业生产和检测设备。

IMR Technology Co., LTD. (IMR) specializes in providing intelligent surface decoration solutions; focusing on the overall supporting of IMS technology, the development and research of IMR transfer foil and special injection molds, it has become a strategic partner of many Fortune 500 companies.

The company has been operating safely for 17+ years, and has established production bases and branches in 16 regions in 7 countries around the world; the company covers an area of more than 20,000m<sup>2</sup>, has a modern dust-free workshop, a constant temperature and humidity measurement room, and is equipped with Europe, the United States, and Japan. Imported high-end professional production and testing equipment.

#### 主要展品 /Products

智能扫地机面板，热水器面板，空调面板

Smart sweeper panel, water heater panel, air conditioner panel



AIRMATE 艾美特

艾美特电器 (深圳) 有限公司  
AIRMATE ELECTRIC (Shenzhen) Co., LTD.

E1-1E41

地址：深圳市宝安区石岩街道办黄峰岭工业区 (518108)

Add: Shenzhen Baoan District Shiyuan street Huangfengling industrial zone

电话 /Tel: 13510870525

传真 /Fax: 0755-2765988-8060

网址 /Web: <https://www.airmate-china.com>

艾美特 1973 年创始于中国台湾，深耕小家电领域 49 年，是一家以电风扇、电暖气等空气改善类产品为核心，全方位打造舒适家居生活的小家电品牌。

品牌灵感源于“AirMate- 空气伴侣”。以“空气”为品牌基因，致力于为每个家庭提供专业、安全、品质的空气环境解决方案。

艾美特拥有来自全球 600 多人的研发精英及工业设计师团队、60 多条组装生产线，产品覆盖中国、韩国、日本、欧洲、美洲等全球 100 多个国家和地区。

AIRMATE founded in 1973 in Taiwan, China, has been deeply engaged in the field of small

household appliances for 49 years. Emmett is a small household appliance brand focusing on air improvement products such as electric fans, electric heaters and so on.

Brand inspiration comes from "AirMate- Air companion". With "air" as the brand gene, we are committed to providing professional, safe and high-quality air environment solutions for every family.

AIRMATE has more than 600 R&D elites and industrial designers from all over the world, more than 60 assembly lines, products cover China, South Korea, Japan, Europe, America and other more than 100 countries and regions.

#### 主要展品 /Products

电风扇 空气循环扇 塔扇 吊扇 工业扇 排风扇 移动地暖 暖风机 油汀 电热毯 电暖桌 吹风机 直发梳 干衣机 烘被机 吸尘器 除螨仪 蒸汽拖把 烤箱 电烤炉 电热水壶 破壁机 榨汁机 空气炸锅 电烧烤炉 足浴盆 加湿器 除湿机

Electric fan, air circulation fan, tower fan, ceiling fan, industrial fan, exhaust fan, mobile floor heater, tinting electric blanket, electric warming table, hairdryer, straight hair comb, clothes dryer, dryer, vacuum cleaner, dehumidifier, steam mop oven, electric oven, electric kettle, wall breaker, juicer, air fryer, electric oven, electric oven, foot bath, humidifier, dehumidifier



**imask**

**爱马斯克 (深圳) 科技有限公司**

**E3-3H71**

**Imask (Shenzhen) Technology Co., Ltd.**

地址: 广东深圳市宝安区西乡街道盐田社区银田路路华丰宝安智谷科技创新园 F 座 301-305 (518000)

Add: Room 301-305, Block F, Huafeng Baoan Zhigu Science and Technology Innovation Park,

No. 4 Yintian Road, Yantian Community, Xixiang Street, Bao'an District,

电话 /Tel: 86-0755-38625555

传真 /Fax: 86-0755-33576666

网址 /Web: www.imask.com.cn

imask 是一家专注于个人护理产品及周边电子电器产品的研发和生产的公司, 公司地址位于深圳, imask 的设计、研发、生产团队均是各自领域的专家。对于 imask 来说, 坚固好用的产品才是用户需要的。imask 不会随便去制造一款产品, 至少需要 1-3 年的时间来验证, 确保用户获得最好的使用体验。

Imask is a company specializing in the development and production of personal care products and peripheral electronic and electrical products. The company is located in Shenzhen. The design, development, and production teams of imask are experts in their respective fields. For imask, a robust and easy-to-use product is what users need. Imask does not randomly manufacture a product, and it takes at least 1-3 years to validate it to ensure that users obtain the best user experience.

#### 主要展品 /Products

imask LX 电动牙刷; imask LX BOX 电动牙刷; imask LS 电动牙刷; imask LS BOX 电动牙刷;

imask LM 电动牙刷; imask LM MAX 电动牙刷;

imask LX ; imask LX BOX; imask LS ; imask LS BOX; imask LM ; imask LM MAX;

**ASD 爱仕达**

**爱仕达股份有限公司**

**N3-3C21**

**AISHADA CO.,LTD.**

地址: 浙江省台州市温岭市东部新区第四街 1 号 (317500)

Add: NO.1,4THSTREEI,EAST NEW DISTRICT,WENLING CITY,ZHEJIANG,CHINA

电话 /Tel: 0576-86199888

传真 /Fax: 0576-86199000

网址 /Web: www.chinaasd.com

创建于 1978 年, 生产基地占地面积达 80 万平方米, 2010 年深交所上市, 8000 万套的巨大产能能力将会成为世界炊具行业最大制造商之一, 国内厨房小家电行业前列, 为打造中国炊具行业第一品牌奠定强大的制造基础, 收购钱江机器人、上海松盛、上海索鲁馨、宁波江晨、广州统一等机器公司, 布局智能制造战略格局; 参股平湖嘉特, 整合智能制造与智能家居产业; 参股前海再保险公司, 作为战略发展项目。

Founded in 1978, Involving cookware, kitchen appliances, cooking utensils and other related business, The production base covers an area of 800,000 square meters, and list in ShenZhen Stock Exchange in 2010.

The huge production capacity make it one of the leading manufacturers possible, ranking top of the household electrical appliances. All these lay a solid manufacturing foundation for the first brand of Chinese cookware field.

ASD has bought some famous machine companies including QianJiang Robot, SongSheng and SuoLuQin in ShangHai, Jiangchen in NingBo, Tongyi in Guangzhou and so on. Formulating an intellectual manufacturing strategic lay out.

ASD also buys stocks of JiaTe in PingHu, integrating intellectual manufacturing and intellectual household industry as one.

ASD takes part in the reinsurance in QianHai as its strategic development project.

#### 主要展品 /Products

金刚旋风炒锅、油里控炒锅、IH 电饭煲

King Kong whirlwind wok, Control the wok in the oil, IH cooker



**爱芯环保科技 (厦门) 股份有限公司**

**W1-1B25**

地址: 厦门同安区西柯镇福明路 288 号

电话 /Tel: 05925700568

传真 /Fax: 05925711198

网址 /Web: http://www.airfc.com/

爱芯环保科技 (厦门) 股份有限公司 (证券代码: 832095) 成立于 2007 年, 始终专注空气净化与智慧物联系统的研究与探索, 致力于为消费者提供高标准室内空气解决方案, 是一家集智能空气净化设备研发、生产、销售、服务于一体的国家高新技术企业。拥有面积超过 12000 m<sup>2</sup> 的标准化生产基地, 率先在空净行业建立 10 万级无尘无菌生产车间, 建立空气净化技术产学研合作基地, 可进行多个项目的检测。



#### 主要展品 / Products

静电除菌空调滤芯、静电除醛空调滤芯、静电除菌空气净化器和、静电除醛空气净化器和、静电除菌中央空气净化器和、静电除醛中央空气净化器和、低阻中效过滤器



#### 安徽乐金环境科技有限公司 LEKING

W2-2G76

地址: 安徽省芜湖市鸠江区富强路 58 号 (241000)

电话 /Tel: 17856699568

传真 /Fax: 0553-2307751

网址 /Web: www.lekingwellness.com

安徽乐金环境科技有限公司基于对空气污染的深入研究,我们首创“极度净化”的产品理念,产品覆盖从商用、医疗、家用、桌面到车内全空间净化产品线。

未来五年,我们仍将致力于以空气净化和水净化为核心,辐射智能卫浴、垃圾厨余处理等健康绿色家电产品。力争成为世界健康和环保家电行业的领导者!

#### 主要展品 / Products

空气净化器 / 空气消毒机 / 加湿器 / 除湿机



#### 聆思科技 LISTENAI

#### 安徽聆思智能科技有限公司

W3-3D66

地址: 安徽省合肥市经济技术开发区宿松路 3963 号智能科技园 E 栋 403 室

电话 /Tel: 055165309986

网址 /Web: www.listenai.com

安徽聆思智能科技有限公司(以下简称“聆思”)是一家专注提供智能终端系统级(SoC)芯片的高科技企业,产品可广泛应用于家居家电、教育办公、消费电子、智能车载等领域。公司自成立以来,持续致力于将全球前沿的人工智能算法与自主领先的芯片设计深度耦合,打造极致性价比的单芯片解决方案,推动万物智联时代的真正来临。

#### 主要展品 / Products

CSK6002 是新一代的 AI 芯片 SoC 产品系列,  
MCU+DSP+NPU 三核异构设计,专核专用;  
内置 ARM Star MCU,可运行应用逻辑,主频最高 300MHz;  
搭载自研 NPU,实现算力升级;  
大容量内存资源,内置 8MB Flash;  
完整的音视频接口,满足人工智能算法需求;  
丰富接口,可实现灵活配置;  
内置自研电源管理系统,功耗可降低 50%,适用于语音、图像、视觉等综合全场景。



#### 安徽万朗磁塑股份有限公司 ANHUI HIGASKET PLASTICS CO.,LTD

W5-5E61

地址: 安徽省合肥市经济技术开发区汤口路 678 号 (230601)

Add: NO.678 Tangkou Road,National Hefei Economic&Technological Development Zone,  
Anhui Province,China

电话 /Tel: 0551-63829988

传真 /Fax: 0551-63829977

网址 /Web: http://www.higasket.com

安徽万朗磁塑股份有限公司是冰箱门封领域的标杆性企业,成立于 1999 年,主要从事家电零部件的研发、生产和销售,主要产品包括冰箱门封、吸塑产品、组件部装产品和注塑产品等,其中冰箱门封条在规模品质、产业链布局、研发实力等方面具有显著领先优势,荣膺工信部“单项冠军产品”称号。

#### 主要展品 / Products

冰箱门封、吸塑产品、组件部装产品和注塑产品等



#### 安徽扬子空调股份有限公司 Anhui Yangzi Air Conditioning Co., Ltd

W3-3E51

地址: 安徽省滁州市经济技术开发区上海北路 588 号

电话 /Tel: 4008877000

网址 /Web: www.yair.com.cn

安徽扬子空调股份有限公司成立于 1988 年,是国内较早的空调生产企业之一,拥有三十余年持续市场服务能力。公司位于安徽省滁州市经济技术开发区,占地面积 500 亩、员工 1500 人,主营家用空调、中央空调和空气源采暖等系列产品,长期致力于人工环境工程研究和舒适性技术研究,是专业的暖通和制冷设备制造制造企业之一。

#### 主要展品 / Products

家用柜挂式空调、家用风管式空调、嵌入式空调、模块式机组、热泵热水机组、空气源采暖机组、末端机组、特种空调等一大批科技含量高、综合性能优异的产品,并在全国各地建立起数百个样板工程。



#### 昂特华德(上海)品牌管理有限公司 ernte Co.,Ltd

E2-2H51

地址: 中国(上海)自由贸易试验区芳春路 400 号 1 幢 3 层 301-228 室 (201200)

Add: Rm301-228, 3th floor, building 1, #400, Fangchun Road, Free Trade Zone, Shanghai, China

电话 /Tel: 13506551782

传真 /Fax: 400-6288-392

网址 /Web: https://www.ernte-cn.com





昂特华德(上海)品牌管理有限公司成立于2020年9月,主要运营ERNTE(昂特)品牌小家电。ERNTE以“Combine Beauty With Simplicity”(中文翻译:与美融合、与简获美)作为品牌理念,在为客户

提供高品质产品的同时,注重客户的使用体验及客户的反馈意见,为客户提供优质的一体化服务。2019年,昂特华德(上海)品牌管理有限公司正式将“ERNTE”引进中国。  
ERNTE Co.,Ltd is established in Sep, 2020, who is mainly operate the ERNTE brand products line. ERNTE slogan “Combine Beauty With Simplicity”, as the brand concept, ERNTE aims to bring good quality products to user, at the same time, ERNTE focus on better client experience and feedback for all products, to improve the products all the time.  
By 2019, ERNTE Co., Ltd release ERNTE full line into China market

#### 主要展品 /Products

电火锅、三明治机、单层烤箱、双层烤箱、手冲壶、多功能料理锅、全自动咖啡机等厨房小家电。  
Main items: Hot pot, sandwich maker, toaster oven, coffee maker and so on.



#### 傲胜 OSIM

E2-2F21

地址:上海市浦东新区国展路1529号天安金融大厦10楼(200125)  
Add: No.1529, GuoZhan Road, Pudong, Shanghai, China  
电话 /Tel: 18701895149  
传真 /Fax: 021-51962880  
网址 /Web: <https://www.osim.com.cn/>

新加坡品牌 OSIM 傲胜是致力于激励健康生活,打造全球优质生活及健康生活产品的推进者。创建于1979年,傲胜不断提升创新技能,推广卓越设计、优异性能与出色质量的产品。

傲胜的业务涵盖四大范畴:「放松+舒缓」、「健康+塑身」、「清新+净化」及「检查+测量」,多年来傲胜已推出一系列享誉业界的创新按摩椅,如养身椅、百变小天后、电竞天王椅,并且成功地将这些产品推广到市场。

OSIM is a global leader in branded healthy lifestyle products. Established in 1979, OSIM is a brand management and niche marketing company with a focus on the well-being of consumers. The Group is innovation-driven and is an IP (intellectual property) developer. OSIM uses innovative retail concepts and constantly enhances its research and development capabilities to produce the most successful well-being products with superior designs, technologies and quality. OSIM's core business currently comes under four complementary categories of well-being: Relax and Relief, Tone and Shape, Clean and Purify, Check and Measure. Each category carries the fundamental theme of well-being, lifestyle and positive attitude. Together, they reflect OSIM's holistic and integrated approach to a healthy lifestyle. Known for its range of innovative massage chairs, OSIM has produced some of the most iconic products such as uDream, uDiva 3 and uThrone, and successfully market these products to the masses.

#### 主要展品 /Products

5感养身椅:AI压力监测,定制专属5感舒压按摩体验  
百变小天后:好沙发会按摩,灵活百变的时尚智能沙发  
电竞天王椅:能按摩的电竞椅,工作、娱乐的间隙,助你充电注能

OSIM uDream: 5-Senses well-being chair, uDream innovative AI-powered technologies to lower body tense, measure, monitor, manage stress.  
OSIM uDiva3: the smart sofa designed for work, play and rest, uDiva3 comes with a range of smart functions to maximize your lifestyle enjoyment, such as full app control, 8 transformations.  
OSIM uThrone: Gaming massage chair. Level up your game with comfort and massage .

## OGNAL - 奥戈那 -

### 奥戈那(西安)贸易有限公司 OGNAL TRADING CO., LIMITED

E1-1G76

地址:陕西省西安市国际港务区港务大道9号C座1602室(710026)  
Add: Xi'an International Port and Logistics District, Shaanxi Province  
电话 /Tel: 029-88083656  
传真 /Fax: 00000000  
网址 /Web: <http://www.ognal.com.cn/>

奥戈那(西安)贸易有限公司,专注设计空气设备类产品的优秀企业,致力于改变全球家庭的室内环境。公司生产研发基地涉及欧洲及亚洲国家,众多高端商超百货都能看到他们的身影。OGNAL带有可供全屋室内空气四季使用方案,包含循环扇、除湿机、取暖器等改善室内空气的可移动设备。OGNAL所有产品在上市前都会经过严格的市场调研和用户测试,所以OGNAL的产品更有力量,更人性化,为对生活品质有更高要求的人设计。

OGNAL TRADING CO., LIMITED, focusing on the design of air equipment products outstanding enterprises, is committed to changing the indoor environment of global families. The company's production and development base involves European and Asian countries, many high-end department stores can see their presence. OGNAL has four seasons of indoor air for the whole house, including circulating fans, dehumidifiers, heaters and other mobile equipment to improve indoor air. OGNAL all products before the market will go through strict market research and user testing, so OGNAL products are more powerful, more humanized, for the quality of life has higher requirements of people design.

#### 主要展品 /Products

取暖器、除湿机、风扇、电热毛巾架等生活电器  
Heaters, dehumidifiers, fans, electric towel racks and other household appliances

## AUX 奥克斯

### 奥克斯空调股份有限公司 AUX

W2-2F11

地址:浙江省宁波市鄞州区姜山镇明光北路1166号(315100)  
电话 /Tel: 0574-88072685  
传真 /Fax: 0574-88072685  
网址 /Web: [www.auxgroup.com](http://www.auxgroup.com)

奥克斯拥有宁波(鄞州区、高新区)、南昌、天津、马鞍山、泰国六个产业基地,在建郑州产业基地,在宁波、珠海、日本建有三个研发中心。拥有强大的研发能力,在变频控制、舒适健康技术、智能前瞻

技术领域处于行业先进水平。近三年在品质创新上累计投入超 30 亿,智能化产品占比达 80%。

2018-2020 年三年空调累计销量全球前三,销售遍布 100 多个国家和地区,并成为 2022 年杭州第 19 届亚运会官方空调独家供应商。

#### 主要展品 /Products

家用空调、中央空调

## ONLIVE

### 奥力孚传动科技股份有限公司 ONLIVE TRANSMISSION TECHNOLOGY CO., LTD

N3-3B21

地址: 浙江台州市三门县朝阳路 11 号 (317100)

Add: 1#Chaoyang Road, Sanmen Industry Zone, 317100 CHINA

电话 /Tel: 13968505126

传真 /Fax: 0576-83310062

网址 /Web: <http://www.cnaolifu.com>

奥力孚传动科技股份有限公司成立于 1980 年,具有 40 年的从事生产同步带的经验。旗下设:浙江马赫传动科技有限公司,盖特鲁传动系统(亚洲)有限公司。公司技术实力雄厚、设备先进、模具精密、检测严格,率先通过了 ISO9001 国际质量体系认证,拥有国内多项专利,是国家高新技术企业。

Onlive was established in 1980, which is the leader in the development and production of polyurethane belts. Professionalism, experience and reliability make Onlive the ideal partner to find solutions for simple or complex applications in linear motion, precise and synchronized transportation, lifting and power transmission

In Onlive, quality is a word not limited to the product but to the whole system. The certification ISO 9001 of our quality system confirms awareness of the quality concept at every level (managerial as well as productive).

#### 主要展品 /Products

聚氨酯同步带,橡胶同步带,同步带轮,齿轮,滚筒,自动化设备,五金件,橡塑制品

Polyurethane synchronous belt, rubber synchronous belt, synchronous belt pulley, gear, drum, automation equipment, hardware, rubber and plastic products



### 奥美森智能装备股份有限公司 OMS MACHINERY CO.,LTD

N1-1A24

地址: 广东省中山市南区大新路 1 号 (528400)

Add: No. 1, Daxin Road, South District, Zhongshan City, Guangdong Province

电话 /Tel: 0760-88885860

传真 /Fax: 0760-88885870

网址 /Web: [www.china-oms.com](http://www.china-oms.com)

奥美森智能装备股份有限公司位于广东省中山市,是从事研发制造自动化、数字化、智能化装备的高新技术企业。

公司产品主要包括管路加工类、换热器加工类、环保节能类、工业机器人、非标自动化生产线等设备。是国内空调换热器生产专用设备的企业。产品具有高精度、高效率、节能、节材等优点,并以优美的外观、

卓越的性能、人性化的操作等特点赢得了海内外广大用户的青睐,用户遍布全球。

OMS Machinery Co.,Ltd. is a High-Tech company, dedicated to the development and production of automatization, digitalization, and intelligentization equipment. Located in Zhongshan, Guangdong.

The company's business is comprised of the following: tube and heat exchanger processing machines, environmental equipment, custom machines, industrial robots, new energy equipment, etc. In China, OMS stands as the leading company in the intelligentization equipment industry, and the largest machinery supplier for air conditioning heat exchanger production. OMS products with feature of high precision, high efficiency, energy and resource saving, and have been highly rated for the exquisite design, outstanding performance, and user-friendliness by customers around the world.

#### 主要展品 /Products

数控开料套螺母弯管一体机,无收缩胀管机,长 U 弯管机,两器折弯机,数控弯管机  
CNC CUTTING AND NUT INSERTED INTEGRATED MACHINE, TUBE EXPANDER, HAIRPIN BENDER, HEAT EXCHANGER FORMING MACHINE, CNC TUBE BENDER

## AUCMA 澳柯玛

### 澳柯玛股份有限公司 AUCMA CO., LTD

W2-2F41

地址: 青岛市西海岸新区太行山路 2 号 (266510)

Add: No.2 Taihangshan Road Qingdao,China

电话 /Tel: 0532-86763023

传真 /Fax: 0532-86760825

网址 /Web: [www.aucma.com](http://www.aucma.com)

澳柯玛创立于 1987 年,是全球领先的制冷家电和冷链设备制造商,是中国制造业 500 强企业、中国轻工业百强企业。澳柯玛研发制造冷柜、冰箱、商用冷链产品、医用冷链设备、生物样本冷库、超低温冷冻设备、冷链物流车、物联网冷链管理系统等全冷链产品和设备,拥有先进的研发中心和智能制造互联工厂,是一个以"全冷链+互联网"为战略目标的企业集团。近年来,澳柯玛进入集成电路、机器人等新兴产业,成为澳柯玛集团的创新业务。

Aucma is a world-renowned equipment suppliers in the fields of refrigeration, Aucma is one of the leading manufacturers in the fields of global refrigeration appliance, home appliances and Environmentally electric vehicle.

Our company's mission is "create a better product, 'Made in China' win the respect of the world". Our goal is to become the industry leader and the growth excellent enterprise, We are a multi-layered, multi-gradient large-scale comprehensive modern enterprise group, We continue to optimize the industrial structure and product structure, and gradually formed a refrigeration appliance as the core business, electric vehicle, the life of electrical appliances, washing machines, vending machines, medical freezer is our emerging businesses, Electric vehicles, marine biology, new energy appliances are our future business.

#### 主要展品 /Products

冷柜、冰箱、电动车、生活电器、洗衣机,自动售货机,超低温冷冻设备等。

Chest freezer, Refrigerator, Electric Vehicle, Home appliances, Washing machine, Vending machine,Ultra low temperature freezing machines etc.

**OLANSI 澳兰斯****澳兰斯健康产业有限公司****Aolans Health industry Co., LTD****E1-1C81**

地址: 广东省广州市南沙区榄核镇海义街 1 号 (511430)

Add: 1 Haiyi Street, Lanhe Town, Nansha District, Guangzhou city, Guangdong Province

电话 /Tel: 020-39906719

传真 /Fax: 020-39906719

网址 /Web: http://www.gzolansi.com

澳兰斯创立于 2009 年, 是一家集健康家电的研发设计、生产销售与售后服务为一体的高科技新型企业。“澳兰斯”品牌, 已连续多年荣膺健康产业十大影响力品牌等多项荣誉, 产品及服务遍布全球 30 多个国家和地区。

**主要展品 /Products**

澳兰斯秉承绿色科技的理念, 持续加大研发投入, 如今, 专利授权超过 100 余项。自主研发生产空气净化系列、净水器系列、富氢水系列、果蔬机系列等健康家电产品。未来, 澳兰斯产品将覆盖环保、医疗、美容、养生、智能家居等健康家电领域, 让全世界用户享受健康美好的品质生活!

**澳汰尔工程软件 (上海) 有限公司****Altair Engineering Software (Shanghai), Ltd.****W4-4B33 4B34**

地址: 上海市静安区恒通路 268 号凯德星贸大厦 2803 (200070)

Add: Room 2803, Capital Square, 268 Heng Tong Road, Shanghai

电话 /Tel: 021-61171666

传真 /Fax: 021-61176188

网址 /Web: www.altair.com.cn

Altair (纳斯达克股票代码: ALTR) 是一家全球技术公司, 在仿真、高性能计算 (HPC) 和人工智能 (AI) 等领域提供软件和云解决方案。Altair 能使跨越广泛行业的企业们在连接的世界中更高效地竞争, 并创造更可持续的未来。公司总部位于美国密歇根州, 服务于 12000 多家全球企业, 应用行业包括汽车、消费电子、航空航天、能源、机车车辆、造船、国防军工、金融、零售等。

Altair is a global leader in computational science and artificial intelligence (AI) and provides software and cloud solutions in design and simulation, high-performance computing (HPC), and data analytics. We enable organizations across all industries to compete more effectively and drive smarter decisions in an increasingly connected world – all while creating a more sustainable future.

**主要展品 /Products**

Altair 多体动力解决方案 /Altair 低频电磁解决方案 /Altair 跌落运输冲击解决方案 /Altair 高频电磁解决方案 /Altair 多学科系统解决方案 /Altair 结构 / 优化解决方案 /Altair 工业设计 / 制造解决方案 /Altair 多学科协同仿真平台 /Altair CFD/ 热分析

Altair® MotionSolve®/Altair® Flux®/Altair® Radioss®/Altair® Feko®/Altair Activate®/Altair® OptiStruct®/Altair® Inspire™/Altair® SimLab®/Altair® AcuSolve®

MICROKILLER  
无机银系抗菌剂**北京艾斯尔科技有限公司****Beijing SR Technology Ltd.****N1-1B24 1B25**

地址: 上海市松江区九亭镇中心路 1158 号 7 号楼 101 室 (201615)

Add: 7#101, NO.1158 Zhongxin Road, Songjiang District, Shanghai, China

电话 /Tel: 021-64700358

传真 /Fax: 021-64706540

网址 /Web: Http://www.sr-business.com

北京艾斯尔科技有限公司成立于 2003 年。公司本着致力于推广环境友好, 降低能耗以及新技术功能性产品的经营理念, 在中国销售国外高端的化工、电子、IT 等行业产品。Microkiller® 为公司的注册商标。Microkiller® 是我们优良稳定的品质, 全力服务的承诺。北京艾斯尔科技有限公司的日本关联公司 SR 商事株式会社是一家致力于发展中日两国友好贸易往来的专业贸易公司, 总部位于日本国东京都新宿。

**主要展品 /Products**

Microkiller® 无机银系抗菌剂、抗菌防霉剂、抗病毒剂、IXE 离子捕捉剂、ARONVIS 聚丙烯酸钠、KESMON 除臭剂、Aron Alpha 粘结剂、OCM 链条等

**北京贝克斯巴斯科技发展有限公司****Becbas(Beijing)Science&Technology Development Co.,Ltd.****N2-2A10**

地址: 北京市朝阳区北苑路 58 号楼 13 层 1305 房间 (100012)

Add: Room 1305, Floor 13, Building 58, Beiyuan Road, Chaoyang District, Beijing

电话 /Tel: 010-64251281

传真 /Fax: 010-64251281

网址 /Web: www.becbas.com.cn

贝克斯巴斯成立于 1998 年, 产品首批获得中青联认证中心“A+ 产品性能”认证, 获得了中国家用电器检测所五级处理能力 (最高级) 认证, 贝克斯巴斯产品还通过了 UL、CSA、ESP、CQC、CE、ROHS、SASO、ISO9001 质量管理体系认证等国内外权威认证, 在上海市消保委 30 个主流垃圾处理品牌品牌的横向评测中研磨能力唯一达到全五星成绩的品牌。

Becbas was founded in 1998, Through UL CSA ESP CQC CE ROHS SASO ISO9001 quality management system certification and other authoritative certification at home and abroad.

**主要展品 /Products**

贝克斯巴斯积极对旗下产品进行革新换代, 推出智能化新品, 创新功能如下:

- ①根据负载智能调节转速, 使静音和速度二者兼得。
- ②智能检测处理数据 (非计时器), 工作完成自动关机。
- ③检测负载判断是否卡机, 智能反转解决卡机。
- ④与天猫精灵、鸿蒙等智能家居平台 IoT 互联。

Becbas is actively innovating and upgrading its products and introducing new intelligent products





## HIYAN海研

### 北京海研自动化科技有限公司

W1-1B41

地址: 北京市顺义区天竺空港工业区融慧园 26-2 四楼

电话 /Tel: 010-64326402

网址 /Web: <http://www.hiyantech.com>

公司成立于 2015 年, 是全球领先的工业视觉与人工智能产品专家, 是国内最早将 5G 和边缘计算创新应用于工业制造的科技企业。

我们始终坚持以领先的自研技术赋能工业“智造”, 目前, 我们已为海尔、美的、格力、海信、老板、方太、博世、奔驰、长城、志邦、我乐等 30 多家全球知名企业提供智能服务, 为十余座“全球灯塔工厂”提供智慧驱动, 家电行业视觉检测应用占有率最高, 并正在加速机器视觉在更多工业领域的产业应用。

#### 主要展品 /Products

公司致力于用领先的机器视觉、深度学习、人工智能、自动化、大数据等技术赋能工业“智造”, 我们始终坚持以创新、扎根一线, 为复杂工业制造领域提供高稳定、高精度、高柔性的数字化云平台 +AI 视觉解决方案, 主要产品包括: 视觉产品 (外观检测、智能防错、尺寸测量、行为识别)、自控产品 (自动贴敷、自动装配、自动检漏、自动锁付)、HiEdgeMind 数字化云平台。



## 北京赫特智慧科技有限公司

E1-1E61

### Beijing Hutt Intelligent Technology Co.,Ltd.

地址: 北京市朝阳区曙光西里甲 6 号时间国际 8 号楼南座 1909 (100027)

Add: 1909, SouthBlock, Building 8, Time International, No. 6 Shuguang Xili A,

Chaoyang District, Beijing

电话 /Tel: 010-58678776

传真 /Fax: 010-58678776

网址 /Web: <http://www.huttwisdom.com/>

北京赫特智慧科技有限公司成立于 2018 年 6 月 25 日, 是一家专注于立面清洁智能产品的研发制造公司, 主要产品为智能擦窗机器人。公司致力于研究家庭环境立面清洁需求, 力求用高品质产品为全球消费者提供优秀的智能清洁服务。

Hutt Wisdom Technology Co., Ltd. was established on June 25, 2018. It is a R&D and manufacturing company focusing on smart facade cleaning products. The main product is smart window cleaning robots. The company is committed to studying the cleaning needs of the home environment, and strives to provide global consumers with excellent smart cleaning services with high-quality products.

#### 主要展品 /Products

赫特变频擦窗机器人 W66

Hutt window cleaning robot W66



## 北京京东世纪贸易有限公司

W1-1C11 1C31

地址: 北京市北京经济技术开发区科创十一街 18 号院 C 座 2 层 201 室 (101111)

电话 /Tel: 010-89126954

传真 /Fax: 010-89126954

网址 /Web: [www.jd.com](http://www.jd.com)

京东集团于 2004 年正式涉足电商领域, 定位于“以供应链为基础的技术与服务企业”, 目前业务已涉及零售、科技、物流、健康、保险、产发和海外等领域。作为同时具备实体企业基因和属性、拥有数字技术和能力的新型实体企业, 京东在各项实体业务上全面推进, 并以扎实、创新的新型实体企业发展经验助力实体经济高质量发展, 筑就持续增长力。

JD.com is a leading supply chain-based technology and service provider. The company's cutting-edge retail infrastructure seeks to enable consumers to buy whatever they want, whenever and wherever they want it. The company has opened its technology and infrastructure to partners, brands and other sectors, as part of its Retail as a Service offering to help drive productivity and innovation across a range of industries.

#### 主要展品 /Products

家用电器, 包括电视、冰箱、洗衣机、空调、小家电等;

Household appliances, including TV, refrigerator, washing machine, air conditioner, small household appliances, etc.



## 北京爵士汇商贸有限公司

N4-4F81

### BEIJING FRESHWAY TRADING CO., LTD.

地址: 北京市密云区鼓楼东大街 3 号山水大厦 3 层 313 室 -3486

(云创谷经理开发中心集中办公室) (101500)

Add: Room 313-3486, Shanshui Building No.3, Gulou East Street, Miyun District, Beijing, 101500, P.R.China

电话 /Tel: 010-62120450

传真 /Fax: 010-62120450

网址 /Web: [www.kitchen.com.cn](http://www.kitchen.com.cn)

北京爵士汇商贸有限公司是一家经销进口家电的专业公司, 与全球各大品牌家电集团、家用电器生产集团、国内各大型百货公司、建材装饰城和房地产开发商有近 20 多年的合作经验, 在行业中享有很高盛誉。

经过 20 多年的发展, 公司现已在全国 58 个省会城市和重点城市发展有 70 余家省市特级经销商, 开设进口电器专卖店约 300 家, 在全国有近 2000 个销售点, 连续 10 多年占有中国进口家电市场的重要领导地位。

Beijing Freshway Trading Co., Ltd. is a professional company distributing imported home appliances. It has nearly 20 years of cooperation experience with the world's major brand home appliance groups, home appliance production groups, domestic large department stores, building materials decoration city and real estate developers, and enjoys a high reputation in the industry.

After more than 20 years of development, the company has now developed more than 70 provincial and municipal premium dealers in 58 provincial capitals and key cities, opened about 300 imported electrical stores, and has nearly 2000 points of sale in the country, occupying an important leading position in China's imported electrical appliances market for more than 10 consecutive years.

#### 主要展品 /Products

吸油烟机, 燃气灶, 电磁炉, 烤箱, 冰箱, 洗衣机, 干衣机, 咖啡机, 洗碗机等。

Range hood, Hob, induction cooker, oven, refrigerator, Washing machine, Dryer, Coffee machine, Dishwasher, etc.

## LIVEN 利仁

北京利仁科技股份有限公司  
BEIJING LIVEN TECHNOLOGY CO.,LTD

N3-3C51

地址: 北京市西城区阜外大街甲 28 号京润大厦四楼 (100032)

Add: 4th Floor, Jingrun Building, No. 28, Fuwai Street, Xicheng District, Beijing

电话 /Tel: 010-68042011

传真 /Fax: 010-68042012

网址 /Web: www.l-rem.com.cn

北京利仁科技股份有限公司成立于 1995 年, 是国内首台电饼铛的创造者, 公司总部位于北京, 致力于小家电产品的研究与开发, 以研发生产小家电为核心内容。并获得发明、外观、实用新型等专利技术 600 多项。形成完善的产品研发、生产、营销、服务体系。

公司通过不断的技术升级, 向消费者推出精致、创新、健康的小家电产品, 努力为消费者提供更好、更便捷的厨房生活解决方案。

Established in 1995 and headquartered in Beijing, Beijing Liven Technology Co., LTD., as the creator of domestically initiated electric baking pan, applies itself to research and development of small home appliances products, which is also its core domain. In addition, the company has been honorably awarded with patents of invention, appearance, utility model and some other of more than 600 in past few years. It totally forms a service system regarding to perfect product research and development, production, as well as marketing. By the way of continuous technological upgrading, the company dedicates to render delicate, innovative along with wholesome small household appliances to consumers, so as to provide consumers with better and more convenient solutions for kitchen life.

#### 主要展品 /Products

公司业务范围包括: 电饼铛、电火锅、空气炸锅、电饭煲、电压力锅、电水壶、多士炉、早餐机、绞肉机、菜馅机、厨师机、真不锈御铁炒锅、煎锅、汤锅、炖锅、加湿器、暖风机、水暖毯、挂烫机、蒸汽熨斗、蒸汽拖把等几十个产品品类。

## NROBOT

北京牛特机器人科技有限公司

E1-1C21

地址: 北京市朝阳区高碑店镇四惠东惠河南街 1111 号龙源通惠大厦 4 层 402 室 (100000)

电话 /Tel: 15110313486

传真 /Fax: 010-52470488

网址 /Web: http://www.nrobot-bj.com

北京牛特机器人科技有限公司是一家专注于研发和销售家用智能科技产品的新兴创业公司。作为智能清洁领域的新兴企业, 能敏锐掌握市场动向, 不断的创新新技术, 先后与国际先进的韩国 EVERYBOT 研发团队、台湾 HOBOT 两个研发团队达成合作; 学习深造让自身时刻处于智能产品技术的前端水平。

公司致力于将优质的智能科技产品带进千家万户, 为用户提供全新的智能生活体验, 提高我们的生活品质。

Beijing Niute Robot Technology Co., Ltd. is an emerging start-up company focusing on R & D and sales of household intelligent technology products. As an emerging enterprise in the field of intelligent cleaning, it can keenly grasp the market trend and constantly innovate new technologies, and has successively reached cooperation with the internationally advanced R & D teams of everybot in Korea and hobot in Taiwan; Study further and keep yourself at the front-end level of intelligent product technology all the time.

The company is committed to bringing high-quality intelligent technology products to thousands of households, providing users with a new intelligent life experience and improving our quality of life.

#### 主要展品 /Products

玻妞擦窗机

雷姬擦地机

洒拖吸拖一体机

Boniu window cleaning machine

Reggie sweeper

Spray drag suction drag integrated machine

## Cenbo 森博营销

北京森博明德营销管理顾问股份有限公司

W4-4E11

Cenbo Marketing

地址: 北京市朝阳区建国路 77 号华贸中心 3 号写字楼 2905 (100025)

Add: L2905, Tower 3, China Central Place 77 Jianguo Road, ChaoYang District Beijing, 10025, China

电话 /Tel: 010-85888330

传真 /Fax: 010-85888330

网址 /Web: www.cenbo.cc

森博营销专注于智慧家庭领域, 让消费者更高效的理解、接受、应用智慧生活解决方案和产品, 以推动智慧生活时代进程。

森博营销分为咨询、营销产品、整合营销三大体系, 其中咨询业务包含: 品牌战略咨询、产品创新咨询、整合营销咨询三大服务; 整合营销业务包含: PR&Social 营销、事件与体验营销板块、电商整合营销板块、视频与直播营销板块四大板块; 营销产品包含三合一、新门店赋能、数字人产品、NFT、虚拟空间等。

Cenbo marketing focuses on the field of smart family, allowing consumers to more efficiently

understand, accept and apply smart life solutions and products, so as to promote the process of the age of smart life.

cenbo marketing is divided into three systems: consulting, marketing products, and integrated marketing. The consulting business includes three services: brand strategy consulting, products innovation consulting, and integrated marketing consulting; Integrated marketing business includes: PR & social marketing, event and experience marketing, e-commerce integrated marketing, video, and live marketing; Marketing products include brand union, new store empowerment, virtual characters, NFT, virtual space products, etc.

#### 主要展品 /Products

基于元宇宙时代,探索未来数字生活对智慧家庭带来的变革。构建智慧家庭元宇宙,通过人、物、环境三要素研究对产业及消费者生活带来的改变。进一步助推智慧家庭元宇宙时代的到来。

人:数字人产品。包含企业数字代言人、数字主播、数字人智慧中控。

物:NFT。包含万物皆可 NFT、联名 IP 发行 NFT。

Based on Metaverse, explore the changes brought by future digital life to smart homes. Build a smart home metaverse, and study the changes in the industry and consumers' lives through the three elements of people, objects, and space. Further, boost the arrival of the era of the smart home metaverse.

People: digital people. Including corporate digital spokesperson, digital anchor, and digital human intelligence central control.

Object: NFT. Including everything can be NFT, NFT joint IP issuance.

Space: C-MetaHome. Including branded virtual space and C-MetaHome.



## 石头科技

### 北京石头世纪科技股份有限公司

E1-1E11

地址:北京市昌平区安居路17号院3号楼石头科技大厦

电话 /Tel: 01053241660

石头科技于2014年7月在北京成立,是一家专注于智能清洁机器人及其他智能电器研发和生产的公司。

石头集结了一群有梦想的科技实干家,在人工智能、软件算法、电子工程、机械结构与供应链管理等多个领域拥有丰富的创新和实践经验。

如今,石头已经成长为一家人全球性公司,产品遍布全球100多个国家和地区,并于2020年2月登陆上交所科创板。未来,石头科技持续探索改善人类生活的前沿科技,致力于用创新简化生活。

#### 主要展品 /Products

石头自清洁扫拖机器人 G20 系列

石头自清洁扫拖机器人 P10 系列

石头自清洁扫拖机器人 G10S Pure 系列

石头自清洁扫拖机器人 G10S 系列

石头自清洁扫拖机器人 G10 系列

石头扫拖机器人 T8 系列

石头分子筛洗烘一体机 H1 全自动家用 12KG 大容量滚筒洗衣机

石头智能洗地机 A10 Plus

石头智能洗地机 A10



探境科技  
INTENGINE

### 北京探境科技有限公司

W3-3B40 3B39

#### Intengine Technology Co.,Ltd.

地址:北京市朝阳区望京宏泰西街博泰大厦5层(100102)

电话 /Tel: 010-62952712

网址 /Web: <https://www.intenginetech.com>

探境科技是一家极具创新力的 AI 边缘芯片领导企业,探境针对智能家电推出的 AI 语音方案,无需联网,无需开发 APP,也无需考虑生态环境,单机即智能,通电即用,将从根本上提升最终的用户体验,大大降低终端消费者的使用门槛。探境的端侧语音方案,与传统 MCU 导入流程相同,且性价比很高,价格几乎与普通 MCU 持平,已覆盖大多数家电产品,为家电产品赋能,为厂商节省时间与研发成本,实现快速智能化,进一步抢占市场先机。

#### 主要展品 /Products

探境智能语音芯片拥有出色的抗噪能力和高精度的语音识别能力,主要有音旋风一代 VOI611;音旋风二代轻量版 VOI311、升级版 VOI621、增强版 VOI721。

探境首款结合公司自研 NLP2.0 算法的 VOI811 芯片,用户无需记忆固定命令词就可以在不联网的情况下,通过自然语言的方式控制目标电器设备,执行既定的操作行为,实现离线 NLP 语音识别与控制。



企业级互动视频云平台

### 北京微吼时代科技有限公司

N4-4A44

#### BEIJING VHALL TECHNOLOGY CO., LTD.

地址:北京朝阳区建国路27号紫檀大厦3层(100000)

Add: 3 / F, red sandalwood building, 27 Jianguo Road, Chaoyang District, Beijing

电话 /Tel: 010-53520909

传真 /Fax: 010-53520909

网址 /Web: <https://www.vhall.com>

微吼创立于2010年,是全球领先的互动视频云平台,一站式互动视频解决方案服务商。目前,微吼已经为40万+行业标杆及企业客户提供了超过2000万次企业直播服务,用户覆盖2.5亿商务人群,应用场景包括数字化直播营销、企业培训、大型峰会现场等,覆盖快消、IT互联网、金融、医疗等数十个垂直行业。其中,世界500强企业中有16%是微吼服务的客户,福布斯-全球品牌价值100强中有35%是微吼服务的客户。

Established in 2010, Vhall is the leading interactive webinar marketing platform in China with over 250 million users. Vhall has currently provided over 20 million webinars for more than 400,000 corporate customers, in corporate training and industry summits, and in areas such as FMCG, IT, Healthcare and Finance. Vhall has provided state-of-the-art webinar services for 16% of the Fortune Global 500 companies and 35% of The World's 100 Most Valuable Brands including Microsoft, Apple, Google, Amazon, AstraZeneca, Nestle, Amway, NIKE etc.

#### 主要展品 /Products

微吼直播、微吼知客、微吼企培、微吼云

Vhall Webcast, Vhall Zhike, Vhall Enterprise Training, Vhall Cloud





与光科技

— SEETRUM —

北京与光科技有限公司

Beijing Seetrum Technology Co., Ltd.

W5-5B05

地址：北京市海淀区清华园街道搜狐网络大厦 5 层 501

Add: 501, 5 / F, Sohu network building, Qinghuayuan street, Haidian District, Beijing

电话 /Tel: 4008898506

网址 /Web: www.seetrum.com

北京与光科技有限公司 (Seetrum) 专注于为全球客户提供先进的光谱芯片、AI 算法和智慧感知方案，为行业赋能，支撑客户高效发展。与光科技由长江学者特聘教授领衔，是一家清华大学科研成果转化的高科技公司。我们的创新性成果快照式 CMOS 超光谱成像芯片具有精度高、成本低、可量产的优势，将为智能手机、医疗器械、机器视觉、增强现实、自动驾驶、智慧城市等行业拓展新的传感维度。与光科技，让光谱感知无处不在。

Seetrum is committed to providing advanced spectral chips, AI algorithms, and intelligent sensing solutions, empowering the industries and supporting our customers' efficient development. We are a high-tech company that originated from Tsinghua University. We have innovated a snapshot CMOS hyperspectral imaging chip with high resolution, low cost, and massive production ability, which will expand sensing applications in smartphone, medical device, machine vision, AR, autopilot, smart city, etc. We are making spectral sensing everywhere.

**主要展品 /Products**

复虹 @ 光谱传感

复虹 @ 系列光谱传感产品是一种可在线检测、环境适应性强、支持大批量生产的新型光学传感方案，可用于环境光或人造光源、颜色和物质的检测分析，支撑进一步实现精细化管理、分级分类、质量控制等应用。复虹系列产品包括多波段可选的传感器 IC、可集成模组式产品组合及相关算法和软件，适用于便携、手持或小型化设备，赋能客户实现光谱传感分析类应用开发。

COCLEAN

北京众清科技有限公司

CoClean Technologies Co., Ltd.

E1-1F81

地址：北京市海淀区农大南路 1 号院 8 号楼 1 层 101-1004 (100089)

Add: Guigu building in Haidian district, Beijing | Tianji building in Baoan district, Shenzhen | Longxi buliding in Wuzhong district, Suzhou

电话 /Tel: 15810516482

网址 /Web: www.coclean.com

众清科技是一家致力于“用科技改善人居环境”的全球化科技公司，由来自清华大学的科学家和全球资深工程师共同创立，为个人及公共空间的清洁和舒适提供创新型的消费电器产品和技术解决方案。众清科技在全球拥有 70 余项专利，核心技术涉及颗粒物空气动力学、空气洁净技术及室内环境控制算法等领域，在室内清洁度和热舒适度的改善方面不断革新，让人们的生活环境更健康、更环保、更

安全、更舒适，创造人人可享的智能美好人居环境。

CoClean is a global technology company dedicated to "using technologies to improve the living environment". Founded by scientists from world top universities and global senior engineers, CoClean provides innovative electrical consumer products and technical solutions for the cleanness and comfort of personal and public spaces. Boasting more than 70 patents around the globe, our core technologies involve particle aerodynamics, air cleaning technology and indoor environment control algorithms. Moreover, we have been consistently innovating to make the living environment healthier, more environmentally friendly, safer, and more comfortable.

**主要展品 /Products**

无线吸尘器，随手吸尘器，车载吸尘器，水离子杀菌除味杯，静音无耗材空气净化器，除醛空气净化器，除醛锰炭包。

Cordless Vacuum Cleaner, Portable Vacuum Cleaner, Car Vacuum Cleaner, Water Ion Air Purifier, Quiet Air Purifier, Formaldehyde Removal Air Purifier-Warrior, Manganese Charcoal Package for Formaldehyde Removal.

beici 蓓慈

蓓慈电器有限公司

Beici Electric Co., Ltd

E3-3H21

地址：芜湖经济技术开发区赤铸山路 88 号 (241000)

电话 /Tel: 0553-5689095

传真 /Fax: 0553-5689030

网址 /Web: www.beici.com

蓓慈电器有限公司，2014 年创立于安徽芜湖经济技术开发区。蓓慈是一家专注于健康按摩小家电和个护小家电的创新型科技企业。主营产品：足浴器、护眼仪、按摩仪、剃须刀、电动牙刷等。蓓慈品牌始终以消费者需求和市场竞争为导向，致力于持续创新研发与高品质保障，为消费者提供优质使用体验的产品。我们希望拥有蓓慈，消费者可以享受更轻松的生活体验。

BEICI, FREE YOUR LIFE.

**主要展品 /Products**

足浴器、护眼仪、按摩仪、剃须刀、电动牙刷

Bissell® 必胜

必胜益康 (上海) 智能科技有限公司

BISSELL (Shanghai) Innovation Technology Co. Ltd.

E1-1F31

地址：上海市静安区南京西路 1168 号中信泰富 15F-1507 必胜 (200040)

Add: NO. 1168 Nanjing West Road, Jing'an District, Shanghai 15F-1507

电话 /Tel: 0755-89497831

传真 /Fax: 0755-89497831

网址 /Web: http://www.bissell.cn/

BISSELL 必胜作为全球家居清洁领导品牌，研发力量雄厚，全球拥有三大研发中心。在 1876 年发明了世界上第一台地毯清扫机之后，BISSELL 必胜持续引领全球行业，开创深度清洁领域，推出包



括突破性的 CrossWave® 多地面吸尘洗地机、布艺清洁、蒸汽清洁、空气净化等多条产品线，全面覆盖家居清洁场景，为消费者提供更多创新高效的清洁解决方案。

The BISSELL® goal is to help you improve the ways you take care of your home, right down to the microscopic irritants. Since 1876, we've spent years developing cleaning tools designed to keep your living environment up to the highest standards.

Here at BISSELL, we're working on not sweating the small stuff—the spilled cereal, the muddy puppy prints, or that overturned glass of wine. After all, we've spent 140 years crafting premium cleaning products that exceed your standards of cleanliness while still leaving you lots of time to enjoy your home, its wonderful occupants and their myriad messes.

#### 主要展品 /Products

洗地机 / 布艺清洗机 / 多功能宠物清洁机 / 蒸汽拖把 / 空气净化器  
CrossWave® /Spot Clean/BARKBATH™ /PowerFresh/ Air Purifier

## Johnboss铂市

铂市 (上海) 智能科技有限公司

N3-3E81

JOHNBOS(SHANGHAI) INTELLIGENT TECHNOLOGY CO.,LTD

地址: 上海市闵行区吴中路 1238 号 7 楼铂市宝客

电话 /Tel: 021-33508535

网址 /Web: <http://www.baoke18.com/>

铂市 (上海) 智能科技有限公司, 专注精致潮流生活领域, 致力于为消费者带来潮流、精致、富有个性创意、功能多样性的厨房及生活小家电潮品。公司携手故宫文化、环球小黄人、变形金刚、小马宝莉等众多顶级知名 IP, 由红点奖、IF 奖的顶尖设计师团队亲自操刀, 将科技产品与 IP 创意相结合, 为消费者打造全新的产品盛宴。

#### 主要展品 /Products

铂市潮嗨锅 铂市小白鲸厨师机 铂市奶油小方微蒸烘烤一体机 铂市星光便携电热水杯 铂市缤纷桶空气炸锅 铂市双子星果蔬清洗机 铂市小热吧即热饮水机



博皓

E3-3D81

prooral

地址: 深圳市龙岗区平湖街道禾花社区富康路 6 号深业物流平湖中心厂房 B  
(宝能智创谷 B 栋) 418 (518000)

Add: 418, building B, Baoneng Zhichuang Valley, Pinghu street, Longgang District, Shenzhen

电话 /Tel: 4000-188-920

网址 /Web: <http://www.prooral.com.cn/index.aspx>

博皓 (prooral) 是瑞圣特科技 (RISUNTECH) 旗下的专业口腔护理品牌, 是国内较早进入口腔护理领域的品牌之一, 十五年来, 博皓一直以深度清洁牙齿和有效的牙龈保健功效为口腔健康保驾护航。博皓品牌产品包含声波电动牙刷、冲牙器、牙齿美白仪等, 是《电动牙刷》团体标准起草单位之一。

Prooral, a professional oral care brand under risontech, is one of the earliest brands to enter the field of oral care in China. Over the past 15 years, prooral has been escorting oral health with

deep tooth cleaning and effective gum health care. Its brand products include acoustic electric toothbrush, tooth flushing device, tooth whitening instrument, etc One of the drafting units of the group standard for electric toothbrush.

#### 主要展品 /Products

冲牙器、电动牙刷

Oral irrigator, Electric toothbrush



博流智能  
Bouffalo Lab

博流智能科技 (南京) 有限公司

W4-4A13

Bouffalo Lab (Nanjing) Co.,Ltd

地址: 南京市江北新区研创园云政街 9 号共享空间大厦 A 座 5 楼 (211800)

电话 /Tel: 025-58280211

传真 /Fax: 025-58280211

网址 /Web: [www.bouffalolab.com](http://www.bouffalolab.com)

博流智能科技 (Bouffalo Lab) 是一家专注于研发业界领先的超低功耗、多协议互联 (WiFi/BLE/Zigbee/Thread/Matter)、高性能音视频边缘计算和智能网关 SOC 的芯片设计公司。凭借丰富的软件和硬件专业能力, 能够为智能家居和各种 AIoT 应用提供全面解决方案。

Bouffalo Lab is a fabless IC design house specialized in both ultra-low power multi-mode(WiFi/BLE/Zigbee/Thread/Matter) wireless AIoT terminal chips and high performance edge computing & smart gateway SOC chips. With our rich HW and SW expertise, Bouffalo Lab is able to provide total solutions for smart home and various AIoT applications.

#### 主要展品 /Products

多模无线全集成 WiFi-6 芯片 ---BL616/618

多模无线全集成边缘计算单芯片 ---BL606P

高性能、低功耗、高安全 WiFi Bluetooth LE Combo--- BL602

高性能、低功耗、多接口 BLE 和 IEEE802.15.4Combo--- BL702/BL706

Multi-mode Wireless Fully Integrated Edge Computing Chip with WiFi-6

Multi-mode Wireless Fully Integrated Edge Computing Chip--- BL606P

High performance, low power, high degree of safetyWiFi Bluetooth LE Combo--- BL602

High performance, low power, multiple interfacesBLE 和 IEEE802.15.4Combo ---BL702/BL706



### 博塔桑尼 (北京) 厨房设备有限公司 Bertazzoni (Beijing) Kitchen Appliances Co., Ltd,

N4-4F81

地址: 北京市朝阳区农展馆南路 13 号瑞辰国际中心 807 (100125)

Add: 807 Richen International Center, 13 South RD of Agriculture Exhibition Center, Chaoyang District, Beijing

电话 /Tel: 010-65000410

网址 /Web: <https://cn.bertazzoni.com/>

意大利高端厨电品牌 BERTAZZONI 博塔桑尼始于 1882 年, 经六代人传承, 至今已有 141 年历史, 产品的设计与技术享誉全球。博塔桑尼起源于意大利北部的艾米利亚-罗马涅地区, 家庭、美食、精工, 是博塔桑尼品牌的三大支柱, 也是一切行动的初心。品牌始终以提升人们的生活品质为使命, 采用先进的工程技术结合独特的饮食文化, 打造人们心目中完美的厨房电器。秉承高级工艺, 精工制造的产品销往 60 多个国家。

Italian high-end kitchen appliance brand BERTAZZONI started in 1882 and has been passed down through six generations, with a history of 141 years. The design and technology of the products are renowned worldwide. Bertazzoni originated in the Emilia-Romagna region in northern Italy. Family, food and engineering are the three pillars of the Bertazzoni, and the original intention of its all actions. The brand always takes the mission of improving people's quality of life, using advanced engineering technology combined with unique food culture to create the perfect kitchen appliances. The finely manufactured products are sold to more than 60 countries.

#### 主要展品 /Products

烤箱、烤箱灶、灶台、烟机、冰箱、洗碗机、酒柜等

Ovens, oven ranges, cooktops, hoods, refrigerators, dishwashers, wine coolers, etc.



### 博西家用电器 (中国) 有限公司 BSH Home Appliances (China) Co., Ltd.

N4-4C31

地址: 江苏省南京市鼓楼区清江南路 18 号鼓楼创新广场 3 栋 8 层 (210000)

Add: 8F Drum Tower Innovation Square No.18 Qingjiang South Road Nanjing Jiangsu

电话 /Tel: 02587762653

传真 /Fax: 02587762653

网址 /Web: <http://www.bosch-home.cn/>

博西家用电器集团是全球领先的家电制造商之一。集团成立于 1967 年, 由最初罗伯特·博世有限公司和西门子股份公司共同组建。自 2015 年初, 博西家用电器集团正式成为博世集团的全资子公司。1994 年进入中国, 历经数十年发展, 目前中国已成为集团在全球最重要的市场之一。博西家电大中华区总部位于南京, 目前在华共投资成立了 7 家子公司, 建立了分别位于滁州和南京的 2 个生产基地, 拥有 1 个全球研发中心及亚太数据交换中心。

BSH Home Appliances Group (BSH Hausgeräte GmbH) is one of the world's leading home appliance manufacturers. The group was founded in 1967 as a joint venture between Robert

Bosch GmbH (Stuttgart) and Siemens AG (Munich). Since the beginning of 2015, BSH exclusively belongs to the Bosch Group. Since BSH's entry into the China market in 1994, and over decades of fast growth, China has become one of the most important markets for the Group worldwide. Headquartered in Nanjing, BSH China holds seven branch companies, operates two production bases in Chuzhou and Nanjing, and has a research and development center and Asia-Pacific data exchange center in Nanjing.

#### 主要展品 /Products

你知道吗? 普通冰箱内每平方厘米就含有 1900 多种多达 114 万个细菌。当你闻到冰箱中的异味时, 说明冰箱内的细菌生长早已失控。博世活氧净对开门冰箱具备最新三重除菌技术, 守护您的健康饮食。搭载德国博世 Sentsortec 专利 VOC 探测器的活氧净模块能够 24 小时检测冰箱腐烂食材, 有效祛除异味, 迅速有效杀灭 99.999% 的细菌。有了它, 您再也不必担心冰箱里的腐坏、异味以及细菌问题, 守护您的健康饮食。

Did you know it has 1.14 million bacteria of 1900 varieties per square centimeter in a normal fridge? When you smell the odor in the fridge, it means bacteria growth already out of control. Now introducing the new Triple Hygiene Guard refrigerator that has the latest hygiene features to protect your diet health. It has German patented VOC gas sensor timely monitors the decay of food, smartly starts purification to removes odor effectively, in the end Active Oxygen kills up to 99.999% bacteria immediately.

By doing so, you don't have to worry about the spoilage, odor and bacteria in the refrigerator any more, helping you protect your healthy cuisines.

## SIEMENS

### 博西家用电器 (中国) 有限公司 BSH Home Appliances (China) Co., Ltd.

N4-4C11

地址: 江苏省南京市鼓楼区清江南路 18 号鼓楼创新广场 3 栋 8 层 (210000)

Add: 8F Drum Tower Innovation Square No.18 Qingjiang South Road Nanjing Jiangsu

电话 /Tel: 18652092868

网址 /Web: <https://www.siemens-home.bsh-group.cn/>

博西家用电器集团是全球领先的家电制造商之一。成立于 1967 年, 由最初罗伯特·博世有限公司和西门子股份公司共同组建。自 2015 年初, 博西家用电器集团正式成为博世集团的全资子公司。1994 年进入中国, 历经数十年的快速发展, 目前中国市场已成为最重要的市场之一。博西家电的大中华区总部位于南京, 目前在华共投资成立了 7 家子公司, 建立了分别位于滁州和南京的 2 个生产基地, 拥有 1 个全球研发中心及亚太数据交换中心。

BSH Home Appliances Group (BSH Hausgeräte GmbH) is one of the world's leading home appliance manufacturers. The group was founded in 1967 as a joint venture between Robert Bosch GmbH (Stuttgart) and Siemens AG (Munich). Since the beginning of 2015, BSH exclusively belongs to the Bosch Group.

Since BSH's entry into the China market in 1994, and over decades of fast growth, China has become one of the most important markets for the Group worldwide.

Headquartered in Nanjing, BSH China holds seven branch companies, operates two production bases in Chuzhou and Nanjing, and has a research and development center and Asia-Pacific data exchange center in Nanjing.



### 主要展品 /Products

全新新门子智感恒鲜多门冰箱，搭载创新 smartGuard 智感恒鲜杀菌技术，内置的 e-nose 传感器可以有效探知食材新鲜度变化，并在食材开始腐败时，自动开启净化功能，延缓腐败食材对其他食材的影响。同时，该产品搭载了西门子零度生物保鲜和百变储鲜功能，满足用户对保鲜的苛刻要求。

The brand new Siemens smart guard series multi-door refrigerator is the first platform equipped with smart guard technology which could detect food freshness status and purify the indoor environment to prolong freshness fully automatically. Thanks to the integrated e-nose sensor, the smart guard system could find the food spoilage from beginning stage and start the purification to kill bacteria and remove bad odor to minimize the impacts on other foods. Meanwhile, this new product is equipped with Siemens iconic hyperFresh technology, plus the new flexFresh tech, satisfy any strict requirement on freshness extension.



### 常熟市天银机电股份有限公司

W2-2G81

地址：常熟市碧溪街道电厂路 19 号 (215513)

电话 /Tel: 0512-52691035

传真 /Fax: 0512-52691888

网址 /Web: www.tyjdc.cc

常熟市天银机电股份有限公司专注于节能节材型冰箱压缩机零部件的研发、生产和销售，是国内颇具规模的水箱压缩机起动机、吸气消音器和热保护器生产厂商，是全球唯一的大批量无功耗类起动机供应商，拥有 80 多项国内外专利，技术创新和研究开发走在国内外同行业前列。公司于 2012 年 7 月 26 日在深圳交易所上市，以企业战略为方向、以观念创新为先导、以机制创新为重点、以市场效果为目标、全方位实现客户要求、不断创造自身价值。

### 主要展品 /Products

冰箱压缩机起动机、吸气消音器和热保护器



### 常州富鸿达电子有限公司

N1-1A37

ChangZhou FHD Electronics Co.,Ltd.

地址：江苏省常州市天宁区郑陆镇工业大道 2 号 (213000)

Add: No.2, Industry Road, ZhengLu town, ChangZhou City, JiangSu Province, China

电话 /Tel: 0519-83822009

传真 /Fax: 0519-88739926

网址 /Web: www.czfhdc.com

常州富鸿达电子有限公司，成立于 2010 年，是一家专业制造蜂鸣器，喇叭，报警器，传感器等电声器件的生产型企业。坐落于江苏常州，占地 5 千平方米，

2011 年已通过 ISO9001 和 TS16949 认证，2013 年拥有自己的注塑车间，SMD 系列，报警器系列，普通电磁式与压电式系列等 10 条生产线以及 2 条喇叭自动线，雇员 2000 人，其中研发 10 人，品质 13 人。公司成立以来，已获取 25 项专利，有两项发明专利。

Changzhou FHD electronics Co.,Ltd is a production-oriented enterprise, which is established in 2010. We are specialized in producing buzzers, speakers, alarms, microphones and other electric acoustic devices. So far there are about 200 employees in our company. We passed the certifications of ISO9001 and IATF16949 in 2011, we've got 22 patent certificates. we set up injection mould workshop, 3D printer and 3 meter Anechoic room. We have ten fully automated piezo buzzer (spring contact) production machines, from feeding materials to fully tested finish product in a single fully automated machine, and it's daily capacity exceed 360,000 pieces. Besides we've got 13 Automated winding machine and several Automated grinding magnet ring machine, Automated diaphragm installation, Automated cover installation, Automated Visual Gluing Machine, Automated Visual Micro Spot Welding Machine, Automatic positioning glue machine, to improve Automated Production Process.

### 主要展品 /Products

蜂鸣器，喇叭，报警器，传感器，雾化片，电感

buzzer, speaker, alarm, sensor, Piezo Atomizer, inductance



### 常州光太电子科技有限公司

N2-2B30

LIGHTBEST CO., LTD.

地址：常州市新北区典雅商业广场 1 幢 424 室 (213022)

Add: No.424, Building 1, DianYa Commercial Plaza, Xinbei District, Changzhou, Jiangsu, China

电话 /Tel: 86-519-85528180

传真 /Fax: 86-519-85528180

网址 /Web: www.light-best.com

常州光太电子科技有限公司，专业生产紫外线杀菌灯、配套供应电子镇流器、紫外线水处理杀菌器，紫外线空气净化器等产品，工厂通过 ISO9001-2015、SGS 认证、消毒产品卫生许可证，产品有消毒产品卫生安全评价报告备案登记，CE、UKCA、Rohs、FCC、UL 认证，广泛应用于光氧催化除臭，空气净化，净水系统，消毒器械，商用及家用智能健康电器等领域的水、空气和物表消毒，为客户提供一站式的解决方案和服务。

Lightbest focus on the manufacturing, R&D and sales of uvc lamps, uvc disinfection equipment, related ballast, uvc water sterilizer, uvc air purifier products. the factory has passed the ISO9001-2015, SGS certification, Disinfection Product Sanitation License, products has disinfection product sanitation and safety evaluation report registration, CE, UKCA, Rohs, FCC, UL certification, widely used in photooxygen catalytic deodorization, air purification, water purification system, disinfection equipment, commercial and household smart health appliances and other fields of water, air and surface disinfection, to provide customers with one-stop solutions and services.

### 主要展品 /Products

紫外线杀菌消毒灯管，电子镇流器，石英套管，紫外线水处理杀菌消毒器，紫外线空气净化器  
uvc germicidal lamp, electronic ballast, quartz sleeve, uv water sterilizer, uv air purifier



**常州科能电子有限公司**

**CHANGZHOU KENNON ELECTRONICS CO.,LTD.**

**E1-1A22**

地址: 江苏省常州市武进高新区西湖路 118 号 (213167)

Add: NO.118,XIHU ROAD,WUJIN,HIGH-NEW TECHNOLOGY DISTRICT JIANGSU,P.R.CHINA

电话 /Tel: 0086-519-86461533

传真 /Fax: 0086-519-86462341

网址 /Web: <http://www.czkennon.com>

常州科能电子有限公司是专业生产各类碳膜电位器、开关、编码器的股份制企业。已有近 20 年的生产经营历史。目前我厂生产的产品有 30 多个系列, 300 多个规格。年生产力达到 8000 万只以上。公司注重质量和环境管理, 已通过 ISO9001:2000 质量管理体系和 ISO14001:2004 环境管理体系的认证。本厂以“品质卓越, 交货快捷, 服务优良”为宗旨。价格合理、诚实守信, 努力使客户满意。

Changzhou Keneng Electronics Co., Ltd. is a joint-stock enterprise specializing in the production of all kinds of carbon film potentiometers, switches and encoders. It has a production and operation history of nearly 20 years. At present, our products have more than 30 series and more than 300 specifications. The annual productivity reached more than 80 million. Focusing on quality and environmental management, the company has passed the certification of ISO9001:2000 quality management system and ISO14001:2004 environmental management system. Our tenet is "excellent quality, fast delivery and excellent service". Reasonable price, honesty and trustworthiness, and strive to satisfy customers.

**主要展品 /Products**

电子元件、电子器件。

Electronic components, electronic devices.



**SEALDO 绍鼎**

**常州绍鼎密封科技有限公司**

**Sealdo Technologies Corporation**

**N3-3B20**

地址: 江苏省常州市新北区玉龙中路 60 号 (213022)

电话 /Tel: 0519-81581893

传真 /Fax: 0519-81581883

网址 /Web: [www.sealdo.com](http://www.sealdo.com)

常州绍鼎密封科技有限公司是一家创新性的高科技企业, 专业从事密封件及各种精密橡胶制品的设计、生产、销售和服务, 致力于通过创新研发和定制化方案为各个工业类客户提供满足其要求的密封元件和高分子材料制品。

Sealdo Technologies Corporation is an innovative high-tech enterprise, specializing in the design, production, sales and service of seals and all kinds of precision rubber parts. Sealdo is committed to providing sealing components for the power and transmission parts of various industrial customers' products through innovative R & D and customized solutions, so as to

continuously improve the competitiveness of customers' products, and at the same time, to ensure the continuous satisfaction of customers by improving their products performance, Sealdo has carried out continuous and long-term R & D investment in the fields of new compound, sealing elements and new functional polymer products.

**主要展品 /Products**

绍鼎的主要产品有: 油封, 橡胶杂件, O 型圈等等。绍鼎生产的产品广泛应用于家电、液压、工程机械和汽车等行业。



**常州申嘉金属制品有限公司**

**CHANGZHOU SHENJIA METAL PRODUCTS CO., LTD**

**N2-2B29**

地址: 江苏省常州金坛区兴辰路 8 号

电话 /Tel: 18136642696

常州申嘉金属制品有限公司, 位于中国长江三角的核心区域, 美丽的龙城—常州, 公是国内最大生产排烟管企业之一。

公司已通过 ISO9001 质量体系认证, 参与制定了住建部 CJ/T199-2018《燃烧器具用给排气管》的标准。

未来, 常州申嘉将以中国式的成本, 世界级的技术和质量, 为全球壁挂炉和热水器客户提供更可信的优质产品和优良服务, 实现公司更大跨越的发展。

**主要展品 /Products**

燃烧器具用给排气管!



**常州五王电机有限公司**

**Changzhou W&W Motor Co., Ltd.**

**W2-2B12**

地址: 江苏常州市新北区春江镇花港路 8 号 (213033)

Add: No.8 Taohuagang Road, Weitang Industrial Zone, Chunjiang Town, Xinbei District, Changzhou City China

电话 /Tel: 86-579-85770033

传真 /Fax: 86-579-85770808

网址 /Web: [www.wuwang.com](http://www.wuwang.com)

五王电机是专业单相罩极异步电动机及相关电气产品的制造商, 以系列罩极电机、轴流风机、水泵电机、贯流风机、罩极水泵为主要产品, 配套家用电器、厨卫电器、医疗器械、工业机械等各类产品, 形成了行业内最为完善的系列罩极电机产品线, 多年来, 公司一直致力于产品的精耕细作, 以品种最全、规格最多、开发最快、服务最优在行业内树立了优良的企业形象, 在罩极电机领域取得了不俗业绩, 获得了国内外用户一致好评。

Changzhou W&W Motor Co., Ltd. which located in Xinbei District of Changzhou, which in the junction of Hu-Ning Expressway, Tongjiang Avenue and 338 Provincial road. We are 16 km

from Changzhou downtown area, and 19 km to Changzhou Airport, and 8 km to Hu-Ning Expressway, and nearly 10 km to Changzhou Station (Shanghai-Nanjing railway). It enjoys the advantage of geography and developed communications by land and air.

#### 主要展品 /Products

罩极电机、轴流风机、水泵电机、贯流风机、罩极水泵



PULSE Optical

### 成都派斯光科技有限公司 CHENGDU PULSE OPTICS-TECH CO.,LTD

W1-1C93

地址：成都蛟龙工业港双流园区水口路1座386号

电话 /Tel: 028-85730267

网址 /Web: www.pulse-gp.com

成都派斯光科技是一家集产品设计、模具加工、生产销售为一体的高新技术企业，公司拥有专业的研发团队、高精密度模具生产设备、十万级无尘净化车间及家电整机组装车间，专业从事空气质量传感器产品研发、生产及销售，主要产品涵盖激光粉尘传感器 (PM2.5、PM10)、CO2 传感器、TVOC 检测模组、甲醛传感器、多合一检测模组。我们致力于将先进的传感技术运用于环境监测，智能家居，工业控制，汽车等领域，服务全球客户。

CHENGDU PULSE OPTICS-TECH CO.,LTD is a national high-tech enterprise integrating product design, mold processing, production and sales, with imported mold processing, thousands of dust-free injection molding, high-precision testing equipments and high-precision design and technical processing team. Specializing in the design, research and development, manufacture of biological laboratory consumables, air quality sensors, intelligent home appliances and related products. CHENGDU PULSE OPTICS-TECH CO.,LTD- Sensor division specializing in the development, production and sales of air quality sensor products, the main products cover laser dust sensor (PM2.5, PM10), CO2 sensor, TVOC detection module, formaldehyde sensor, multi-in-one detection module. We are committed to the application of the advanced sensor technology in environmental monitoring, smart home appliances, industrial control, automotive and other fields, serving customers around the world.

#### 主要展品 /Products

传感器事业部：专业从事传感器研发与制造

主要产品涵盖：

粉尘传感器、CO2 传感器、TVOC 检测模组、甲醛传感器、多合一检测模组。

产品应用领域：

智能家居、环境监测、汽车电子。

PULSE Sensor--Specializing in air quality sensors design、R&D and manufacturing.

Main products:

GAS sensor(Carbon dioxide sensor, TVOC detection module, Formaldehyde sensor).

Particle dust sensor(Laser PM2.5 sensor, Laser PM10 sensor、Infrared dust sensor、Large particulate matter(BSP) sensor).

Multi-function air quality detection module

Application:

Intelligent home appliances, Environmental monitoring, Automotive electronics

## CHANCOO

### 橙厨

#### 橙品科技(北京)有限公司

N3-3A47

地址：北京市朝阳区黄厂路锦珑文创意园 8321 室

电话 /Tel: 010-85705207

「CHANCOO 橙厨」由屡获德国 IF、德国红点、美国 IDEA 等 50 余项国际大奖的工业设计团队创立，专注于都市年轻女性打造兼具美学与性能的高颜值厨电产品。

在「CHANCOO 橙厨」眼中，家电不只是冰冷的工具，更是能够装点生活空间的精美艺术品。每一优雅的曲线，到每一处精益求精的细节，都是一份对于理想生活的美好愿景。

主要展品 /Products

「CHANCOO 橙厨」以水桶包为灵感创作出美感与性能兼具的便携榨汁机，为便携易用设计的 C 型圆润提手，巧妙贯穿整套产品，视觉美感高度统一的同时也带来了更便捷、更优雅的移动体验。以性感的实用主义，致敬大胆时尚、热爱生活的女孩们。

## Uniorange 橙色云

#### 橙色云互联网设计有限公司

W3-3F41

#### Uniorange Internet Design Co., Ltd.

地址：山东省烟台市莱山区山海路 113 号橙色科技大厦 (264003)

Add: O-tech Building, 113 Shanhai Road, Laishan District, Yantai, China

电话 /Tel: 0535-6768301

传真 /Fax: 0535-6723172

网址 /Web: <https://www.orangecds.com/>

橙色云互联网设计有限公司是杰瑞集团旗下独立运营公司，承载了杰瑞集团进入开放竞争领域和大众消费刚需市场，汇聚全球 32 万研发工程师，致力于让全球用户享有更智慧、更高效、更环保的科技成果，引领协同生态、奉献智慧产品、缔造美好生活。2021 年，橙色云着力布局橙色云生态链版图，通过与工程师及中小微企业利润分成的模式，帮助中小微企业成长，工程师创业。目前橙色云生态链产品已覆盖美妆个护，清洁家电等多个领域。

Founded in 1999, Jerih Group is an innovation-driven diversified corporation. Nearly 7,000 employees with great expertise are working diligently in over 70 countries and regions around the world.

Uniorange Internet Design Co., Ltd., an independent subsidiary of Jerih Group, was established in 2015 and headquartered in Yantai China. With the "super brains" technical team consisting of experts and doctors from various majors and fields, and the great capacity in integrating the supply chain system in China, Uniorange can convert the ideas, proposals and drawings into products in the shortest time. Up to now, our product lines have covered many fields such as beauty, personal care, cleaning appliances and so on.

#### 主要展品 /Products

橙色云研发的产品包括：美妆个护类产品和家庭清洁类产品，其中美妆个护类包括：超静音高速吹风机、超氧冲牙器、胶囊冲牙器、贝壳冲牙器、大肚瓶冲牙器、冰激凌系列电动牙刷、极光系列电动牙刷；家庭清洁类产品包括：智能洗地机 P1、双滚刷洗地机 P2、智能扫拖机器人 i1、智能扫拖机器人 i2。

Intelligent Robot Vacuum and Mop Cleaner

① vacuum and mop 2 in 1 ② automatic mop washing ③ automatic water refilling and drain ④ automatic dust collection ⑤ automatic identification of carpet ⑥ automatic base cleaning ⑦ hot air drying for mop ⑧ electrolytic water sterilization

Double Roller Brush Cordless Wet & Dry Vacuum Cleaner

True double roller brushes, much cleaner!

- ① Two-way automatic traction Saving efforts in pushing and pulling ② Intelligent identification of dirt Variable frequency cleaning ③ Dual airflow for efficient suction to clean out dirt instantly Ultra Silent High Speed Hair Dryer  
① 110,000rpm High Speed BLDC ② 100,000,000+ Negative Ions/m<sup>3</sup> ③ 4 Precise Heat Settings  
④ 3 Precise Speed Settings ⑤ 57dB Low Noise ⑥ 390g Lightweight ⑦ One Button Self-cleaning  
⑧ Alternating Mode of Cold and Hot Air  
Electric Toothbrush  
① Powerful stain removal, 42,000 vibrations per minute ② Soft care, Only 0.15mm per DuPont bristle ③ Battery capacity 2000mAh, charge once a year



前沿科技品牌设计

### 宠米科技 & 上品设计 & 凡辉设计

W3-3B10

#### MIPet & TOP Design & Fanhui Design

地址: 北京东城区崇文门新世界中心写字楼 A 座 1118 室 (100062)

Add: Room 1118, Building A, Chongwenmen New World Center office building, Dongcheng District, Beijing

电话 /Tel: 010-67083007

传真 /Fax: 010-67083007

网址 /Web: <http://www.fanhuidesign.com/>

宠米科技: 用设计创造价值, 主打艺术家居, 宠物用品在家的空间中和谐与装饰。IP 艺术设计的衍生品设计, 可米生活联合设计系列智能家居设备。

上品设计: 知名的工业设计咨询与服务机构, 成立至今曾服务全球品牌超 1000 家, 项目超 3000 个; 荣获设计奖项近 300 个, 合作企业包括戴姆勒奔驰、特斯拉等。

凡辉设计: 自初创以来, 致力前沿科技趋势的研究与设计, 坚持“快速、跨界、高端”理念, 为现代企业提供贴身式设计服务。

Mipet: create value with design, the main is art home, pet supplies in the home space harmony and decoration. IP art design derivative design, Kome Life joint design of a series of smart home equipment. Top Design: Well-known industrial design consulting and service institutions, established so far has served more than 1000 domestic and foreign brands, completed more than 3000 projects; He has won nearly 300 design awards, and cooperated with Daimler Benz, Tesla and other fortune 500 companies.

Fanhui Design: Since its inception, it has been committed to the research and design of cutting-edge scientific and technological trends, adhered to the concept of "fast, cross-border and high-end", and provided intimate design services for modern enterprises.

#### 主要展品 /Products

宠米科技: 宠物智能家居设计, 文化用品设计, IP 形象衍生品设计。

上品设计: 品牌策略、ID 设计、MD 设计、硬件研发、样机生产、模具生产等。

凡辉设计: 品牌战略定位, 平面设计, 产品设计, 空间设计, 用户体验设计。

Mipet: Pet smart home design, cultural articles design, IP image derivative design.

Top Design: Brand strategy, ID design, MD design, hardware research and development, prototype production, mold production.

Fanhui Design: Brand strategy, PI design, Graphic design, Space design, User experience design.

## SKYWORTH

### 创维

创维集团有限公司

W4-4E51 4E71

Skyworth Group Co., Ltd

地址: 中国广东省深圳市南山区高新南四道创维半导体设计大厦东座 22 楼 (518057)

Add: 22F East Tower, Skyworth Semiconductor Design Building, High-Tech South 4th Rd, Nanshan, Shenzhen, China

电话 /Tel: 0755-26010001

传真 /Fax: 0755-26010001

网址 /Web: [www.skyworth.com](http://www.skyworth.com)

创维集团有限公司 (Skyworth Group Co., Ltd) 成立于 1988 年, 主要从事多媒体业务 (智能电视系统、酷开系统的互联网增值服务等)、智能系统技术业务 (家庭接入系统、智能制造、汽车电子系统及其他电子产品等)、智能电器业务 (智能空调、智能冰箱、智能洗衣机、智能厨卫等)、现代服务业业务 (家电保养维修、大物流服务业、对外贸易、建设发展、融资租赁、园区物业经营等) 等四大业务。

Skyworth Group Co., Ltd. was founded in 1988, mainly engaged in multimedia business (smart TV system, COOCAA system Internet value-added services, etc.), smart system technology business (home access system, smart manufacturing, automotive Electronic systems and other electronic products, etc.), smart electrical appliances business (smart air conditioners, smart refrigerators, smart washing machines, smart kitchens, etc.), modern service business (home appliance maintenance and repair, large logistics service industry, foreign trade, construction and development, financial leasing, Park property management, etc.) and other four major businesses, the group has two listed companies, Skyworth Group (HK00751) and Skyworth Digital (000810), several high-tech enterprises, with a national enterprise technology center, a national industrial design center, it is the first batch of demonstration units of "Made in China 2025".

#### 主要展品 /Products

多媒体业务 (智能电视系统、酷开系统的互联网增值服务等)、智能系统技术业务 (家庭接入系统、智能制造、汽车电子系统及其他电子产品等)、智能电器业务 (智能空调、智能冰箱、智能洗衣机、智能厨卫等)、现代服务业业务 (家电保养维修、大物流服务业、对外贸易、建设发展、融资租赁、园区物业经营等)。

Skyworth Group Co., Ltd. was founded in 1988, mainly engaged in multimedia business (smart TV system, COOCAA system Internet value-added services, etc.), smart system technology business (home access system, smart manufacturing, automotive Electronic system)



慈溪恒宁电器有限公司

E3-3B43

Cixi Henning Electric Appliance Co., LTD

地址: 浙江省慈溪市周巷镇周浒公路 528 号 (315325)

Add: 528 Zhouhu Road, Zhouxiang Town, Cixi City, Zhejiang Province

电话 /Tel: 0574-63451800

传真 /Fax: 0574-63451822



浙江慈溪恒宁电器有限公司，是一家专注于智能无线充电吹风机、母婴儿童恒温吹风机系列产品研发设计、生产和销售为一体的综合型企业，厂房占地面积 13000 平方米，员工 150 余人。公司坚持“产品创新、诚信为本”的经营理念，广纳社会各界英才，为全球消费者打造舒适和健康的环境而努力，公司通过 ISO9001:2008 质量管理体系，3C 认证，产品获得外观和实用专利。

Zhejiang Cixi Hengning Electric Appliance Co., Ltd. is a comprehensive enterprise focusing on the research and development, design, production and sales of intelligent wireless charging hair dryer, maternal and child constant temperature hair dryer series products. The factory covers an area of 13,000 square meters and has more than 150 employees. The company adheres to the business philosophy of "product innovation, integrity-based", inviting talents from all walks of life, and making efforts to create a comfortable and healthy environment for global consumers. The company has passed ISO9001:2008 quality management system, 3C certification, and obtained appearance and utility patents for its products.

#### 主要展品 /Products

LY-A2000 锤子款 / HN-W101 火炬款 / HN-W301 婴童款

LY-A2000 Hammer model / HN-W101 Torch model / HN-W301 Baby model



歙悦

XIN YUE

#### 慈溪吉星电器有限公司

N3-3B27

地址：慈溪市崇寿工业区经七路 111 号 (315300)

电话 /Tel: 13884446300

网址 /Web: www.nbgstar.com

慈溪市吉星有限公司成立于 2009 年，位于慈溪市崇寿工业区经七路 111 号，是以生产厨房小家电，厨房小工具为主，工贸一体的企业。

公司建筑面积 15000 多平方米，技术力量雄厚，可为客户提供产品和模具设计、模具制造、塑件生产等一系列服务。

公司主导产品有搅拌机、电动切菜机，空气炸锅，打蛋机等，产品远销欧美、东南亚等 30 多个国家和地区，公司拥有多项国内外专利，并通过 CE、GS、ETL 等国际安规认证。

Our leading products include mixer, electric vegetable cutter, air fryer, egg beater, etc. Our products are exported to more than 30 countries and regions, such as Europe, America, Southeast Asia, etc. We have many domestic and foreign patents and have passed CE, GS, ETL and other international safety certifications.

#### 主要展品 /Products

搅拌机、电动切菜机，空气炸锅，打蛋机等

mixer, electric vegetable cutter, air fryer, egg beater, etc.

## JOEYING®

慈溪久盈电器有限公司

W2-2A41 2A42

CIXI JIUYING ELECTRICAL CO.,LTD.

地址：浙江省宁波市慈溪市横河镇镇埋马村罗家路 1 号 (315318)

Add: No.1 Luojia Rd, Maima Village, Henghe Town, Cixi, Ningbo, China

电话 /Tel: 0574-63831536

传真 /Fax: 0574-63831536

网址 /Web: www.joeying.cn

慈溪久盈电器有限公司成立于 2013 年，致力于生产高质量、智能化的取暖器。公司专注于取暖器的设计、研发、生产与销售，拥有平板取暖器、户外取暖器、工业取暖器、干鞋机、毛巾架等多个类别的产品。通过 ISO9001 和 BSCI 认证，拥有 GS、CE、ETL、SAA、EMC、REACH、RoHS 等证书，产品销往欧美的多个国家和地区。

Cixi Jiuying Electrical Co., Ltd., established in 2013, is committed to producing high-quality and intelligent heaters. Our company focuses on the design, development, production and sales of heaters. We have many categories of products, such as panel heater, outdoor heater, industrial heater, shoe dryer, towel rail and so on. We have ISO9001 and BSCI certification, our products have GS, CE, ETL, SAA, EMC, REACH, RoHS and other certificates. Our products are sold to many countries and regions in Europe and America.

#### 主要展品 /Products

户外取暖器、平板取暖器、对流取暖器、工业取暖器、干鞋机、毛巾架等

Outdoor Heater, Panel Heater, Convector Heater, Industrial Heater, Shoe Dryer, Tower Rail

#### 慈溪叁仁电器有限公司

N2-2A22

CIXI SANREN ELECTRICAL APPLIANCE CO.,LTD.

地址：浙江省宁波市慈溪市观海卫镇罗鸣南路 95-2 号 (315315)

Add: No.95-2, Luoming South Road, Guanhaiwei Town, Cixi, Ningbo, China

电话 /Tel: 17771516909

传真 /Fax: 057463745888

网址 /Web: www.cxsanren.com

慈溪叁仁电器有限公司(前身为宁波采臣电器)是一家专门从事于高品质生活电器制造的生产企业。企业秉承“为品质生活而生”的理念，为消费者提供高性价比的家用电器产品。企业从建立开始就不断的加强和优化各项管理，从产品研发、检验、生产、成品出货到售后服务，建立了一整套的质量控制体系。同时企业也非常注重售后信息反馈和建议并应用到产品的改善。经过几年的努力和发展，已经和世界各国的客商建立了良好合作关系。

CIXI SANREN ELECTRICAL APPLIANCE CO.,LTD.

#### 主要展品 /Products

榨汁机、原汁机

JUICER

**BEILIAN**  
贝联电器**慈溪市贝联电器有限公司**  
**Cixi Beilian Electrical Appliance Co., Ltd.**

地址: 慈溪市观海卫镇卫西村

电话 /Tel: 0574-63631975

慈溪市贝联电器有限公司成立于 2011 年, 全国小家电之乡。目前贝联电器拥有产品研发、模具开发、塑料注塑、产品组装等专业制造设备, 已发展成为设计研发、生产、销售于一体的综合性工贸企业, 并与众多国内外知名 OEM 品牌企业合作, 如霍尼维尔、海尔、美的、等国内外知名品牌。目前公司年空气净化器产能已达 3 百万台以上。

**主要展品 /Products**

空气净化器 空气加湿器 空气炸锅

**E2-2B20 2B21****宁波超宇阀门科技**  
**Ningbo Chaoyu Valve Technology Co., Ltd.****慈溪市超宇汽车配件有限公司**

地址: 浙江省慈溪市长河镇沧大公路 333 号

电话 /Tel: 0574--63406343

网址 /Web: <http://www.cxchaoyu.cn/>

本公司专业生产各种排烟气防火止回阀, 有款式六十余种, 产品配套宁波方太厨具, 杭州老板电器, 广东华帝股份, 广东欧派美家居, 浙江帅康电器, 浙江帅丰电器, 广东万家乐电器等知名电器公司, 本企业是住建部住房协会会员企业, 是国家排气管道专利联盟企业, 本公司防火止回阀共有六十余项国家专利, 欢迎全国各地的有识之士与我们合作, 共创排气管道行业之辉煌。

**主要展品 /Products**

防火止回阀

**N1-1B15****TILAW 黛朗****慈溪市高美电器有限公司**  
**Cixi Gaomei Electric Appliance Co., Ltd.**

地址: 浙江省慈溪市观海卫镇师东村

电话 /Tel: 13429202613

本公司是一家专业从事小家电研发、生产、销售于一体的现代化企业, 专业生产以下产品:

空气炸锅系列: 可视型空气炸锅。

公司厂房面积为 10000 平方米, 现有员工 350 名, 工程技术人员 11 名, 其中高级工程师 3 名, 产品先后通过 CCC、CE、ROHS 等认证, 并顺利通过了 ISO9001: 2015 质量管理体系认证。

**主要展品 /Products**

可视型空气炸锅

**N3-3B26****ihenglMa****慈溪市恒马电器科技有限公司**

地址: 慈溪市观海卫镇工业园西区

电话 /Tel: 13486010612

慈溪市恒马电器科技有限公司位于慈溪市观海卫镇工业园西区。公司始创于 2011 年, 占地面积约 40 万平方米, 是一家经营生产迷你型单双缸洗衣机、全自动洗衣机、冷暖风机、脱水机系列产品的公司。目前, 公司拥有各种注塑机 120 台, 并配有独立的洗衣机设计部, 能实现自主研发、自主生产, 产品远销中东、东南亚、非洲、南美、东欧等地区。

**主要展品 /Products**

mini washing machine air cooler

**W3-3C115 3C116****JOYHI 佳欢****慈溪市佳欢电器有限公司****Cixi Jia Huan Electrical Appliance CO., LTD**

地址: 浙江省慈溪市观海卫镇工业园区东区 (315314)

电话 /Tel: 86-0574-63630178

传真 /Fax: 86-0574-63630564

网址 /Web: [www.cnjoyhi.com](http://www.cnjoyhi.com)

慈溪市佳欢电器有限公司 (简称佳欢电器) 成立于 1998 年, 是慈溪市首家大型冷风机制造工厂。公司位于慈溪市观海卫镇工业园东区, 目前拥有冲压、组装、零配件生产等 5 大车间, 占地面积 12000 余平。近年来, 公司秉承“佳欢出品、质造精品”核心价值观, 牢牢锁住质量环, 向市场推出了大批物美价廉的冷风机、暖风机、厨余垃圾处理器产品。佳欢电器期待成为您的朋友和合作伙伴, 共创互惠双赢的未来。

**主要展品 /Products**

冷风机、暖风机、无雾加湿器、厨余垃圾处理器

**E3-3B41 3B42****凯乐**  
**KAILE****慈溪市凯乐电器有限公司**  
**Kailer Home (China)**

地址: 浙江省慈溪市新浦镇洋龙工业区 (315322)

Add: Yanglong Industry Zone, Cixi, Ningbo, China

电话 /Tel: 0574-58974788

传真 /Fax: 0574-58974786

网址 /Web: [www.cxkaile.com](http://www.cxkaile.com)

成立于 1998 年, 凯乐电器 (Kailer Home) 专注于风扇和取暖器及其他小家电生产和销售。技术创新, 前瞻设计和品控驱动, 凯乐汇集大量的优秀科技人才, 并且与多个国家的知名企业合作。凯乐的客户遍及世界各地等 20 多个国家, 证书包括 CE, GS, KC, CB, ROHS 等。拥有年生产能力 500 万台的小家电

**E1-1A05**

生产线,专业的产品配送及专业的售后服务团队。

Established in 1998, Kailer Home (慈溪凯乐电器) focuses on small home appliances. Main products include air circulator, DC fan, air humidifier, air purifier, fan heater, quartz heater, carbon fiber heater, infrared heater, PTC heater and outdoor heaters etc. The continuous efforts on research and development and our focus on quality control brought our long-term and reliable orders from blue chip clients across the world, including Europe, Southeast Asia, East Asia, Middle East, South America etc. with approvals of CE, GS, KC, CB, ROHS etc.

#### 主要展品 /Products

空气循环扇, DC 风扇, 空气加湿器, 空气净化器, 暖风机, 石英取暖器, 碳纤维取暖器, 红外取暖器, PTC 取暖器, 户外取暖器等

Air Circulator, DC fan, Air Humidifier, Air Purifier, Fan Heater, Quartz Heater, Carbon Fiber Heater, Infrared Heater, PTC Heater and Outdoor Heaters etc.

## MONGSUN 梦森

### 慈溪市梦森电器有限公司

E2-2B27

地址: 浙江省慈溪市横河镇梅湖村航渡桥桥南 15 号

电话 /Tel: 0574-63190213

慈溪市梦森电器有限公司——位于浙江省慈溪市横河镇, 风景优美, 交通便捷。本公司是一家设计与生产为一体的新型企业, 专业生产汽车车载充气泵、车载吸尘器、迷你轮胎充气泵等车载电器, 已有 10 余年的生产经验, 产品内销各个省市并远销海外, 并与很多著名的企业都有着稳定、良好的合作, 本公司已通过 ISO9001 认证体系。

#### 主要展品 /Products

车载吸尘器、车载充气泵

## SHINEFON 雪峰® PIPE INDUSTRY

### 慈溪市瑞峰管业有限公司

N2-2A27

CIXI RUIFENG PLASTIC PIPES CO., LTD.

地址: 浙江省慈溪市长河镇工业开发区马凉亭路 425 号

电话 /Tel: 0574-63401658

慈溪市瑞峰管业有限公司创建于 2010 年 4 月, 主要产品是燃气软管, 这是关乎千家万户用气安全的产品, 无论是材料配方的改进、机器设备的更新、人员骨干的培训及产品性能的创新都在为“安全”而努力。2010 年, 我们获得首批燃气软管国家工业产品生产许可; 2015 年, 通过天祥国际认证检测, 产品达到了 BS EN16436-2014 欧盟标准。我们陆续获得的 10 多项实用新型和外观专利, 多次荣获“消费者信得过产品”称号。

#### 主要展品 /Products

家用燃气管, 钢丝管, 金属铠装管, 金属包覆管



## 时代模具

### 慈溪市时代模具有限公司

W2-2B24 2B25

CIXI SHIDAI MOULD CO.,LTD

地址: 浙江省慈溪市掌起镇工业路 19 号 (315313)

Add: No.19 Gongye Road ,Zhangqi Industry Zone, Cixi City ,Zhejiang ,China

电话 /Tel: 18858029966

传真 /Fax: 0574-63752262

网址 /Web: <http://www.nbdongxia.com/>

慈溪市时代模具有限公司成立于 2001 年, 坐落于浙江省慈溪市掌起镇工业区, 占地面积 12000 平方米, 建筑面积 22000 余平方米, 公司自成立以来致力推行 ISO9001 质量管理体系, 专注白色家电、厨房电器及汽车配件等模具开发与制造。公司坚持使用先进设备制造高品质的产品, 拥有完善的工艺流程, 有自主设计, 研发能力, 并且引进德国精密五轴铣削设备, 模具 EDM 设备, 合模机, 三维坐标测量机等先进的模具设备。

Cixi Times Mold Co., Ltd. was established in 2001, is located in Zhangqi Town Industrial Zone, Cixi City, Zhejiang Province, Covers an area of 12000 square meters, construction area of more than 22000 square meters, the company since its inception is committed to the implementation of ISO9001 quality management system, focus on white goods, kitchen appliances and auto parts mold development and manufacturing. The company adhere to the use of advanced equipment to manufacture high-quality products, has a sound process, independent design, research and development capabilities, and the introduction of Germany precision five-axis milling equipment, mold EDM equipment, die closing machine, three-dimensional coordinate measuring machine and other advanced mold equipment.

#### 主要展品 /Products

空调、洗碗机、消毒碗柜、净水器、空气净化器、空气消毒机、除湿机、移动空调模具制造、注塑代加工  
Air conditioning, dishwasher, disinfection cupboard, water purifier, air purifier, air disinfection machine, dehumidifier, mobile air conditioning mold manufacturing, injection molding on behalf of the processing

## SPRING

### 慈溪市斯泊林电器有限公司

E1-1A12 1A13

Cixi City Sibolin Electric Appliance Co.,Ltd

地址: 浙江省宁波市慈溪市附海镇工业园区新塘路 678 号 (315300)

电话 /Tel: 0574-55869398

传真 /Fax: 0574-63562685

网址 /Web: [www.nbspring.cn](http://www.nbspring.cn)

慈溪市斯泊林电器有限公司成立于 2005 年, 公司已通过 ISO9001 和 BSCI 等验厂, GS, ETL, CE, ROHS, LFGB, REACH 检测等系列认证, 主要产品有吸尘器, 除螨仪, 棉花糖机, 巧克力机, 爆米花机, 冰淇淋机, 面条机, 干果机, 蒸锅等各种家用电器和 party 用品。

Cixi City Sibolin Electric Appliance Co., Ltd., located in Fuhai Industrial Zone, Cixi City, Zhejiang Province, is an important light industrial town in the Yangtze River Delta, which is adjacent to the

great Shanghai economic circle by Hangzhou Bay Cross Sea Bridge. The company was founded in 2003, covering an area of about 20000 square meters, and now has about 200 employees and 8 work lines. The annual output value is more than 20 million dollars.

The products have passed ISO9001 and Walmart factory inspection, and have passed GS, ETL, CE, ROHS, LFGB, REACH, etc. The main products are Vacuum Clean, UV Vacuum Clean, Chocolate Fountain, Cotton Candy Maker, Popcorn Maker, Ice Cream Maker, Ice Shaver, Food Dehydrator, Steamer and other household appliances and party supplies.

#### 主要展品 /Products

吸尘器, 除螨仪, 棉花糖机, 巧克力机, 爆米花机, 冰淇淋机, 面条机, 干果机, 蒸锅等各种家用电器和 party 用品。

Vacuum Clean, UV Vacuum Clean, Chocolate Fountain, Cotton Candy Maker, Popcorn Maker, Ice Cream Maker, Ice Shaver, Food Dehydrator, Steamer and other household appliances and party supplies.



#### 慈溪市夏蒙电器有限公司 CIXI CITY SHAR MOON ELECTRIC CO.,LTD.

W2-2D61

地址: 慈溪市新浦镇荣誉村西工业区纬二路 6 号 (315322)

电话 /Tel: 86-0574-23662866

传真 /Fax: 86-0574-23696308

网址 /Web: www.oekaen.com

慈溪市夏蒙电器有限公司是一家专业化、现代化、国际化的高新技术企业。从事研制开发、生产、销售水家电系列产品。夏蒙电器有限公司始终坚持贯彻执行科学标准的管理方法,本着树立百年品牌,促进人类健康饮水事业的蓬勃发展为己任,持续、高速、健康地从一个成功走向另一个成功。

CIXI SHAR MOON ELECTRIC CO.,LTD located in CIXI NINGBO city,zhejiang province,china.A professional factory specialized in producing water purifier,water dispenser,Ro filter,mineral water pot,Alkaline water machine and so on.

With 13 years produce experience and a strong professional team,all products can be attained the CE LFGB SGS quality standard.99% products export all over the word with good quality reputation.

Speedy delivery and comprehensive,cutting-edge products offering help you in selecting the right protection for your application as well as to provide you with samples of our products for evaluation.Looking forward to our cooperation as well as our friendship for the long haul.

#### 主要展品 /Products

夏蒙牌净水器、饮水机和纯水机

## HONGGE

#### 慈溪市香格电器有限公司

E2-2A20 2A21

地址: 浙江省慈溪市坎墩街道联发路 838 号慈溪市香格电器有限公司 (315300)

电话 /Tel: 13484201391

传真 /Fax: 0574-63041861

网址 /Web: http://www.cnhongge.cn/

香格电器创立于 2007 年,是空净系列产品集研发,生产及销售为一体的实体型企业。是中国负离子行业标准的起草单位之一,空净协会会员单位。服务于国内外众多一线知名品牌。公司主营负离子,等离子,臭氧,水离子等离子模块元器件,同时还开发了一系列净化消杀类产品,加湿器等。特别是加湿器产品,以日韩市场为主打,以“质美”“形美”“价美”为宗旨依靠十几年积累的行业经验,成为业内领先的生产销售单位。

#### 主要展品 /Products

负离子发生器, 等离子模块, 臭氧发生器



#### 慈溪市兴泓电器有限公司

W5-5A10

地址: 浙江省慈溪市长河镇长河工业园区

电话 /Tel: 0574-63407756

网址 /Web: http://www.fudeer.cn/

电热水龙头行业的 OEM 代工厂 小家电 品牌 - 弗德尔, 厨房家电

#### 主要展品 /Products

厨房小家电: 即热式水龙头, 即热式小厨宝, 即热式淋浴器



#### 慈溪市众邦电器有限公司

W5-5A23 5A24

#### CIXI ZHONGBANG ELECTRIC APPLIANCE CO.,LTD.

地址: 浙江省宁波慈溪市观海卫镇观南路 111 号 (315315)

Add: NO.111 Guanfu south road, Guanhaiwei town, Cixi,Ningbo,Zhejiang,China.

电话 /Tel: 0574-23450267

传真 /Fax: 0574-23450267

网址 /Web: WWW.CXZBDQ.COM

慈溪市众邦电器有限公司是一家集研发、生产、销售两季小家电产品为主的民营股份制企业,公司地处素有“小家电王国”之称的浙江省慈溪市观海卫镇,主要产品包括电风扇、空调扇和电暖器等。

公司现有厂房面积 34000 m<sup>2</sup>, 各式生产线 12 条, 具备年生产两季小家电 300 万台的生产能力。公司拥有一批高素质的科研技术人员以及在各品牌企业工作经历的管理人员。生产的产品具有典雅大方的造型、安全、节能、方便、性价比高等优点。

Cixi Zhongbang Electric Appliance Co., Ltd. is a private joint-stock enterprise focusing on R &



D, production and sales of two seasons of small household appliances. The company is located in Guanhaiwei town, Cixi City, Zhejiang Province, known as the "Kingdom of small household appliances". Its main products include electric fans, tower fans, air conditioning fans and electric heaters.

The company has a plant area of 30000 square meters, 12 various production lines and a production capacity of 3 million small household appliances in two seasons a year. The company has a group of high-quality scientific research and technical personnel and management personnel with working experience in various brand enterprises. The products have the advantages of elegant and generous modeling, safety, energy saving, convenience and high cost performance.

#### 主要展品 /Products

无叶扇, 落地扇, 塔扇, 空调扇, 取暖器。

Bladeless fan, Stand fan, Tower fan, Air cooler, Heater.

## 铂瑞

### 慈溪市卓家电器厂

#### CIXI ZHUOJIA ELECTRIC APPLIANCE FACTORY

地址: 浙江省宁波市慈溪市周巷镇双乐村东湖塘 113 号

电话 /Tel: 13566076643

慈溪市卓家电器厂专业专注电动牙刷的研发和生产, 公司位于“家电之都”慈溪, 是集产品设计、研发、生产、销售、服务为一体, 致力于为消费者带来放心产品。成立于 2014 年, 凭借在电动牙刷领域的专业水平和成熟的技术, 在工控领域迅速崛起。依靠科技求发展, 不断为用户提供满意的高科技产品, 是我们始终不变的追求。

#### 主要展品 /Products

专注电动牙刷的研发和生产



WANLONG

### 慈溪万陇电器有限公司

#### Cixi Wanlong Electrical Co., Ltd

地址: 慈溪万陇电器有限公司 (315324)

Add: No. 658, Kaifa East Road, Zhouxiang Town, Cixi, Zhejiang, China

电话 /Tel: 13626847964

传真 /Fax: 23458990

网址 /Web: www.jianbow.com

慈溪万陇电器成立于 1999 年, 作为专业生产发热管的厂家, 日产量可达到 20 万根以上。经过几年的发展, 于 2009 年, 我们开始成品制作, 现公司拥有发热管和电热炉、煎烤器等厨房小家电两大生产基地。

E2-2B33 2B34

N1-1A25

Cixi Wanlong Electrical Co., Ltd was established in 1999. As a professional heating element manufacturer, we supply to most hotplate factories in China with a 200,000pcs daily output. After several years' development, we set-up our own hotplate production line in 2009, our products export to all over the world, such as Germany, USA, Canada, France, Spain, South Africa, Middle East etc, and we have cooperated with many big famous companies, including Walmart, Auchan, Lidl, Steba, Kmart, Target, Watson, Salton, Aroma etc. Our factory are qualified by ISO9001:2015, BSCI and our products are certificated by GS, CE, CB, RoHS, ETL, ERP, PAH, REACH declaration. After 20 years' endeavor and expansion, in 2019 we moved into a new factory. The larger area (15000m<sup>2</sup>), more assembly lines and higher intellectualized equipment ensure our production capability and on-time delivery.

#### 主要展品 /Products

电热炉, 电烧烤炉, 电炖锅, 电烤锅, 华夫机, 三明治机, 多士炉等

Hot plate, BBQ, frying pan, deep grill, sandwich maker, and so on



### 慈溪微虎电器科技有限公司

E1-1B20

#### CIXI MICROHOO ELECTRICAL APPLIANCE TECHNOLOGY CO., LTD.

地址: 浙江省慈溪市宗汉潮塘工业西区宗怡路 58-1 号 (315301)

Add: NO.58-1 Zonghan Chaotang West Industrial Zone, Cixi, Zhejiang, China

电话 /Tel: 13456161032

慈溪微虎电器科技有限公司处于中国家电基地之一的浙江慈溪市。成立于 2019 年 3 月。专注于个人冷风扇和无雾加湿器的研发, 生产与销售。

产品定位于中高端, 价格亲民, 性价比高。微虎电器致力专注于新兴品类个人冷风扇的研发, 创新与开拓。小步快跑, 不断迭代, 为用户带来刚需实用美好的产品, 也带来不同凡响的用户体验, 营造用户舒适的个人微环境。

未来沿着此产品线不断研发与延伸, 陆续面世。亦会有其他品类拓展。

#### 主要展品 /Products

个人空调扇, 无雾加湿器

Personal Air Cooler, Evaporative Humidifier



### 村田 (中国) 投资有限公司

W1-1B51

#### Murata

地址: 上海市黄浦区湖滨路 150 号企业天地 5 号楼 11 层 (200021)

电话 /Tel: 021-32054616

网址 /Web: www.murata.com

村田制作所于 1947 年成功开发了第一只陶瓷电容。其生产的陶瓷电容、滤波器、射频元件等产品为手机、电脑、家电等设备带来了“内部革新”。村田以特有的技术不断推进元器件的小型化、高可靠性, 在各个领域提供高精产品和解决方案。事业也从通信、电脑等领域拓展到汽车电子、智能医疗等新兴领域, 并不断寻找新的可能性。

#### 主要展品 /Products

负离子发生器, 臭氧发生器, 高频多极连接器, 测试座连接器, 柔性压电传感器 PicoleafTM

爱丽思  
IRIS OHYAMA**大连爱丽思欧雅玛发展有限公司**  
**IRIS OHYAMA****E1-1C51**地址: 大连市保税区海天路 7 号  
电话 /Tel: 041187572999-3274

作为爱丽思集团的第一家公司, 大连爱丽思欧雅玛工贸有限公司是为了满足日本市场而设立的生产企业, 1996 年 5 月动工, 1997 年 1 月正式投入生产。爱丽思集团是日本爱丽思集团拥有 100% 股权的独资企业, 是目前大连保税区及出口加工区中综合规模位居前列的外资企业。

**主要展品 /Products**

家电用品, 家居用品, 园艺用品, 健康护理用品, 宠物用品



汉和住生集团

**大连汉和住生科技有限公司**  
**Dalian Kanwajuusei Technology Co.,Ltd****E2-2G71**地址: 辽宁省大连市甘井子区华东路 48 号 (161111)  
Add: 48 Huadong Road, Ganjingzi District, Dalian, Liaoning Province, China  
电话 /Tel: 400-1155-787  
传真 /Fax: 400-1155-787  
网址 /Web: <http://www.kanwa-china.com>

汉和住生集团是成立于 2008 年的中日合资企业, 旗下公司发展达到 14 家。

公司主要从事进口品牌产品销售, 现已运作品牌达 20 多个, 取得了多个品牌的全国总代资格。汉和住生集团本着培养一代, 发展一代的原则, 为打造综合贸易平台努力, 致力于为广大客户持续提供卓越的产品和服务, 为人们创造更智能、更健康、更舒适的家居生活。

KANWA Zhusheng Group, a Sino-Japanese joint venture, is established in 2008. with 14 subsidiary corporations. The business fields include internet, presents, supermarkets, warehousing and logistics, property, tobacco and alcohol, stores, media, tea, medical care, construction projects, and etc.

With excellent national operating experience, we have operated more than 20 imported brands, and have obtained the national general representative qualification of many brands, such as Japanese Peacock, Japanese Extreme Brand, Japan Doric, Japan UMIC, Japan Aimeide and other imported brands. The Group makes use of a mature trading system to carry out brand promotion and operation of various brand products in all channels.

We have 34 self-operated Tagawa Town imported brand home-life museums

We have Settled in

44 Sam systems nationwide

67 OLE systems nationwide

441 terminal counters nationwide  
213 online stores nationwide  
healthier and more comfortable home life for people.

**主要展品 /Products**

孔雀多功能电烤盘 PKP-A12(B) 产品功能特点: 1、烤盘分区设计, 烤肉区和平面区, 满足不同需求; 2、内置可拆卸式储油盘, 方便清洁; 3、可拆卸可调节温控器, 对温度掌控更方便; 4、双层水性不粘涂料防粘效果更好; 5、防烫胶盆增加产品安全性; 6、烤盘内铸发热管导热性更强。

Grill EB-12AB household multi-function electric grill---a kind of household smokeless electric grill pan,

**Product features:**

1. Baking tray partition design, barbecue baking area and plane baking area, to meet different needs;
2. Built-in removable oil storage pan, easy to clean;
3. Removable adjustable temperature controller, easy and convenient for temperature control;
4. Anti-stick with double layer water-based non-stick coating;
5. Anti-scald rubber basin to increase product safety;
6. The heat conduction of the inner casting heating tube in the roasting pan with good heat conductivity for baking.

**大同电子科技(江苏)有限公司****N4-4A10**地址: 江苏省苏州市吴江经济技术开发区益字路 118 号 (215000)  
电话 /Tel: 86-512-62718068  
传真 /Fax: 86-512-62718068  
网址 /Web: <http://www.tatung.com.cn>

大同(股份)公司创立于 1918 年, 为台湾首批上市企业之一(公司代号: 2371)。

集团总部位于台北, 是全球性综合大厂台湾大同伴随台湾文化, 写著台湾景象, 更刻画著台湾精神, 企业经过近一个世纪的淬炼, 成就台湾经典家电品牌的荣誉。大同电子科技(江苏)有限公司为大同(股份)公司成立之海外分公司, 从事大同家电产品零组件 / 配件供应及品牌家电零售渠道拓展, 致力提供国内消费者更优质的厨房及生活家电产品。

**主要展品 /Products**

大同电锅, 大同多功能料理锅, 大同多功能料理壶(养生壶 / 料理锅), 大同多功能榨汁机



TEKA

**德格国际贸易 (上海) 有限公司**  
**Teka Int. Trading (Shanghai) Co., Ltd.**

**N4-4C81**

地址: 上海市徐汇区文定路 200 号盛源恒华大厦 1506 室 (200030)  
Add: Room No.1506, Shengyuan Henghua Building, No. 200 Wending Rd., Xuhui Dist.  
Shanghai 200030, P.R.China  
电话 /Tel: 53076901  
传真 /Fax: 53076906  
网址 /Web: www.teka.com

Teka 集团是德国 Heritage B 控股公司的子公司, 是家用厨房电器和卫浴等消费用品行业的专家。TEKA 集团旗下拥有 Teka, Kuppersbusch, Intra, Mofem 和 Thor 等不同定位的专业厨卫品牌。在欧洲, Teka 集团, 是欧洲最重要的不锈钢水槽、嵌入式厨房电器和整体卫浴产品的制造商之一。TEKA 在全球拥有 15 家工厂和 4000 名员工, 业务遍及五大洲的 120 多个国家。

Teka, All began in 1924.

Teka Group belongs to the German Heritage B holding, being the consumption section specialist in kitchen and bath household appliances. Teka Group comprehends different worldwide leading brands, such as Teka, Küppersbusch, Intra, Mofem or Thor. The group, with more than 140 years of history, has become an international example of household appliances and sanitary manufacturing. Teka brand is one of the most important European manufacturer of stainless steel sinks, built-in kitchen appliances, and bath solutions As of today, Teka owns 15 factories and 4,000 workers around the world, with presence in more than 120 countries in five continents.

Teka is concerned about the emotional details in life, and integrates kitchen culture with emotional experience in life. With minimalism, breaking through conventions, cutting-edge fashion and ultimate user experience as the design cornerstones, Teka provides complete kitchen solutions for our customers.

**主要展品 /Products**

烤箱, 蒸箱、微波炉, 咖啡机, 灶具, 油烟机, 冰箱, 酒柜、洗碗机, 洗干衣机, 食物垃圾处理器等。  
Oven, Steam Oven, Microwave, Coffee maker, Hob, Hoods, Refrigerator, Wine Cooler, Dishwasher, Laundry, Food Waste Disposer

**FineSky**

**德国法兹全屋净水**

**德国法兹全屋净水**  
**Germany FineSky Whole House Water Purification System**

**N4-4A42**

地址: 德国汉堡 (邮编 20459) 鲁丁斯马克特 20 号 (518001)  
Add: Roedingsmarkt 20, 20459 Hamburg, Germany  
电话 /Tel: 0755-33003998  
传真 /Fax: 0755-33003990  
网址 /Web: http://www.finesky.cn

德国 FineSky 法兹全屋净水由 Julius Dopslaff 先生 1936 年创立的工厂研发制造, 总部位于德国斯图加特, 拥有超过 85 年的净水经验, 是全球权威的专业水处理设备制造公司之一, 生产基地遍布欧洲和亚洲。Julius Dopslaff 先生作为德国卫浴暖通及管路行业的领军人物, 带领研发团队成功制造了全球第一台中央前置过滤器。在全球已拥有超过 130 项发明专利, 产品经过德国权威机构 DVGW 严苛认证。

The German FineSky whole house water purification plant was developed and manufactured by a factory founded by Mr. Julius Dopslaff in 1936. It is headquartered in Stuttgart, Germany. It has more than 85 years of water purification experience and is one of the world's authoritative professional water treatment equipment manufacturing companies with production bases all over the world include Europe and Asia. Mr. Julius Dopslaff resolutely devoted himself to the business of optimizing the quality of municipal water supply. Came and lead the R&D team to successfully manufacture the world's first central pre-filter. The group has more than 130 invention patents around the world, and its products have been strictly certified by the German authority DVGW.

**主要展品 /Products**

德国法兹 FineSky 全屋净水系统  
德国 BLVT 不锈钢管道系统

Germany FineSky Whole House Water Purification System  
Germany BLVT Stainless Steel Piping System



**德国库尔兹集团**  
**KURZ GROUP**

**W5-5E71**

地址: 中国安徽省合肥市经济技术开发区锦绣大道 168 号 (230601)  
电话 /Tel: 55163859000  
传真 /Fax: 55163859093  
网址 /Web: www.kurz.com.cn

德国库尔兹集团作为热烫印技术全球公认的佼佼者, 超过 110 年的传承, 累积着丰富的表面装饰经验和复杂工艺的应用技巧。我们为家电行业, 消费电子产品行业, 化妆品行业, 汽车行业, 家具行业等提供卓越的表面装饰处理; 我们不仅是您的膜箔供货商, 我们提供的是设计与智能融为一体的表面装饰整合方案, 是您项目开发的理想合作伙伴。

KURZ is a worldwide leader in thin film technology with over 5,500 employees.

KURZ develops and manufactures decorative and functional coatings that are applied to carrier foils and employed for a wide variety of products: for automotive components, cell phones, TVs, washing machines, furniture, packaging, books, textiles, bottle labels, bank cards and lots more. KURZ coatings decorate products, enhance brands, label goods, protect surfaces and prevent counterfeiting. Moreover, KURZ inserts optical elements with digital functions, linking the visual to the virtual world.

KURZ provides complete solutions that include project consultancy plus machine and die technology. The KURZ Group has over 30 sites worldwide and produces under standardized quality and environmental standards in Europe, Asia, and the USA. With a global network of subsidiaries, agencies and sales offices, we ensure short paths, reliable delivery and individual on-site assistance.

**主要展品 /Products**

IMD UNIFY 數碼燙後印助您應對塑膠零部件個性化設計及小批量生產的市場趨勢，能夠快速回應市場需求。

再生材料 RECOPOUND®。

鍍 Indium 金屬裝飾效果，無需電鍍就可以實現真鍍鍍外觀，並且適用於智慧 5G 應用。

BIOFENSE® 抗菌表面技術為產品表面提供持久衛生防護。

PolyTC® 觸摸感測器，高透明和高導電特性，適用於各種尺寸的觸控屏，助您為人機界面創造更多的創新控制功能

The main products that KURZ will be presenting includes IMD UNIFY, RECOPOUND®, Indium, BIOFENSE®, and PolyTC®.

**德心智能科技(常州)有限公司****W3-3C51****Definition Smart Technology (Changzhou) Co.,Ltd**

地址：虹漕路 88 号 H88 越虹广场 H88 越虹广场 B 座 9A (210024)

Add: 9A, Building B, H88 Plaza, No.88 Hongcao Road, Xuhui District, Shanghai

电话 /Tel: 4006002790

网址 /Web: www.downtii.com.cn

【德心小宝】是德心智能科技有限公司集结业内精英、历经 x 年潜心研发、打磨进入市场的一款智能家居产品。

凭借已成熟运用于汽车行业的毫米波雷达技术，德心小宝开辟出全新的应用场景、更人性化的使用体验。

通过先进雄厚的技术力量和人工智能算法帮助家庭健康管理，德心小宝在不侵犯任何隐私的前提下，全天候精准感知，提升居家安全感。

聚焦家庭安全、家庭健康，赋能居家生活。

“无形守护 爱未延迟”

Downtii is a smart home product developed by Definition Smart Technology (Changzhou) Co., Ltd. which has gathered industry elites.

With the millimeter-wave radar technology that has been maturely used in the automotive industry, Downtii has created a new application scenario.

With advanced technology and artificial intelligence algorithms, Downtii can accurately monitor 7/24h without infringing any privacy, and help health management.

Focus on family safety, family health, and make home life more comfortable.

"Downtii, the love in time "

**主要展品 /Products**

德心小宝健康守护仪 D1W、德心小宝健康守护仪 D2W、德心小宝健康守护仪 D3V

Downtii D1W、Downtii D2W、Downtii D3V

**SANTUS****帝泉(上海)贸易有限公司  
Vino Fontaine Pte Ltd****N4-4B41**

地址：上海市黄浦区九江路 686 号腾飞元创大厦 3 楼 (200001)

Add: 3F Ascendas Innovation Place, No.686 Jiujiang Road, Huangpu District, Shanghai, China

电话 /Tel: 4001726887

网址 /Web: www.mysantus.com

SANTUS 帝泉贸易有限公司是一家新加坡公司，是以为人们带来全新生活方式为目标的创新型企业。首度涉猎领域是葡萄酒保鲜，团队历经数年研发和试验，经上百次修改调整，为大家带来了一代又一代高端葡萄酒保鲜机，以层层进阶的智能保鲜科技改变葡萄酒饮用传统，无论居家，餐厅，商业，办公等各种场景，都可随时乐享新鲜如初的美酒，喝出自己的节奏。

Conceived in 2013, SANTUS™ specializes in lifestyle products that make the timeless flavors of wine last longer. This empowers individuals to fully indulge in their love for wine by giving them more time to savor every sip - be it at home or elsewhere. Newly launched, the SANTUS™ Andante series is committed to the environment while reducing wine waste. Through the use of environmentally friendly materials, we hope to help our customers do more with less.

**主要展品 /Products**

SANTUS Andante 采用具备创新氧气吸附技术 (Oxygen Absorber) 的除氧滤芯，将瓶内氧气率有效降至 0.1%，可以在保证口感的同时将葡萄酒的最佳赏味期由 3 天延长至 14 天，确保每一滴酒在第 14 天时也能新鲜如初，让消费者掌握品酒的自由度，喝出属于自己的节奏。一个除氧滤芯可以支持约 8 瓶葡萄酒的保鲜。

Over 600million bottles of wine are wasted yearly in UK due to over-pouring or improper knowledge of wine storage. SANTUS Andante is using Oxygen Absorber to filter O2 from the air in the bottle, hence extending its taste and flavor for up to 14 days. Designed to look like a piece of art suitable for any settings, its translucent door subtly reveals the label of the wine in. Setting up is a breeze and dispensing wine is simply the touch of a button. The use of sensors and light strips in the machine allow users to be alerted as the strips count down the 14 days to wine expiry, all while enhancing its aesthetics. These alerts are further extended to WeChat, where you can also set the temperature to as low as 10°C for the White. Finally, we started this company with the end in mind, by taking a social responsibility route to reduce wine waste. We continue in this route by making sure where possible that our materials are environmentally friendly like being biodegradable or recyclable.





**东莞动源机电科技有限公司**

**Dongguan Dynamic Source Mechanical And Electrical Technology Co., Ltd.**

**N1-1A40**

地址: 广东省东莞市石碣镇单屋村阳光路 5 号三楼 (523290)

Add: 3rd Floor, No.5 Sunshine Road, Shan Wu Estate Shijie Town, Dongguan City, Guangdong Province, China

电话 /Tel: 0769-81803030

传真 /Fax: 0769-81803031

网址 /Web: www.MOGIK.hk

东莞动源机电科技有限公司是一家专业研发、生产、销售隔膜泵、泡沫泵、气泵、无刷水泵、活塞泵、蠕动泵等微型自吸泵的高新技术企业。广泛应用于各类家电产品,如:饮水机、豆浆机、咖啡机、电蒸炉、洗衣机、皂液机、自动酒具等。特别是在饮用水领域,动源科技拥有完善的微型水泵配套方案。

推行质量管理体系。符合 ROHS、PAHS、REACH、FDA 等产品认证。坚持遵守环保、安全法规,实施安全工艺,制造安全产品。

Dongguan Dynamic Source Mechanical And Electrical Technology Co., Ltd. is a professional research, production and marketing of diaphragm pump, foam pump, air pump, brushless water pump, piston pump, peristaltic pump and other micro self-priming pump high-tech enterprises. It is widely used in all kinds of household appliances, such as water dispenser, soybean milk machine, coffee machine, electric steamer, washing machine, soap dispenser, automatic wine set, etc. Especially in the field of drinking water, dynamic source technology has a perfect supporting scheme of micro water pump.

Implement quality management system. Comply with ROHS, PAHs, reach, FDA and other product certification. Adhere to environmental protection and safety regulations, implement safety processes and manufacture safety products.

**主要展品 /Products**

微型隔膜泵又叫微型真空泵、微型水汽两用泵,内部通过机械装置使泵内部的隔膜做往复运动,并且在进口处能够持续形成真空或负压,出口处形成微正压。

无刷直流水泵使用永磁无刷直流电机的原理,转子加上叶轮,外壳设计为液体流动的腔体结构,无碳刷摩擦。特点是安全高效,低功耗。较有刷电机寿命长,噪音低。

活塞泵又叫电动往复泵,结构分为单缸和多缸。活塞泵靠活塞往复运动,使得泵腔工作容积周期变化,实现吸入和排出液体。

Brushless DC pump using the principles of permanent magnet brushless DC motor, coupled with an impeller on its rotor, the housing structure is designed to constitute a cavity fluid flow, no carbon brush friction. It is characterized by safety, high efficiency and low power consumption. Compared with brush motor, this kind of pump has longer life span and lower noise.

Micro diaphragm pump refers to vacuum pump and is also called micro water-air pump, through the mechanical device to make the diaphragm reciprocating movement inside the pump, and it can continuous from vacuum or negative at the inlet and from the micro positive pressure at the outlet.

The piston pump is also called electric reciprocating pump, the structure is divided into single cylinder and multi cylinder. Piston pump by piston reciprocating motion, make the pump chamber work volume cycle change, realize the suction and discharge of liquid.

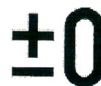

**东莞共全海外品牌策划有限公司**

**E1-1G66**

地址: 东莞市长安镇新安社区红山一街一号 9 层 905 室

电话 /Tel: 16620033256

日本正负零 (±0) 品牌, 是日本知名设计品牌, 成立于 2003 年。由日本工业设计大师深泽直人担任设计总监。“恰到好处”是正负零品牌的设计理念,“恰到好处”意味着不多不少刚刚好。家用产品摒弃物欲影响和冗余设计,只保留产品恰到好处的本真使用价值和美感。

**主要展品 /Products**

风扇、吸尘器、加湿器、取暖器、水壶等



**东莞航电新能源科技有限公司**

**W5-5B10 5B11**

**Dongguan Hangdian New Energy Technology Co.,Ltd**

地址: 东莞航电新能源科技有限公司 (523775)

Add: Dongguan Hangdian New Energy Technology Co.,Ltd.,

电话 /Tel: 076982239721

传真 /Fax: 076982239721

网址 /Web: www.dgapsc.com

东莞航电新能源科技有限公司隶属于贵州航天电源科技有限公司, 是一家电池研发、制造、销售的国家高新技术企业。厂房总面积约 9000 多平方米,在职工工超 200 人,其中含研发技术人员超 10 人。公司致力于为客户提供高性价比的优质产品。航电本着“科技先导、以人为本”为经营理念,被广东省评为守合同重信用企业,生产的电池产品广泛用于家电、智能家居、便携储能、电动两轮与滑板车、灯具照明等领域。

Dongguan Hangdian New Energy Technology Co.,Ltd., a subsidiary of Guizhou Aerospace Electronic Co., LTD., is a national high-tech enterprise specializing in battery research and development, manufacturing and sales. HD has a total plant area of more than 9,000 square meters with over 200 employees, including more than 10 R&D Technicians.

HD is a company dedicated to provide customers with cost-effective quality products, since it grows and HD constantly improve the product quality requirements, we cooperated with the famous brand companies such as huawei, BYD, millet brand ect, and acquired many customers highly recolonization.HD is a trustworthy enterprise with the business philosophy of "science and technology guide, people-oriented", which is rated as a contractual and trustworthy enterprise by Guangdong Province. APSC battery products are widely used in household appliances, smart home, portable energy storage, electric two-wheel and scooter, lamps and lighting and other fields.

**主要展品 /Products**

18650-2000mAh, 2200mAh, 2500mAh, 2600mAh, 3000mAh 数码型、动力型电芯, 及 PACK 电池组成品。

18650-2000mAh, 2200mAh, 2500mAh, 2600mAh, 3000mAh digital batteries, power batteries, and battery PACK .

**东莞厚博精密塑胶科技有限公司****W1-1B21**

地址: 东莞市长安镇厦岗社区茅山西街5号  
电话 /Tel: 1371375837

厚博精密是一家集研发、生产销售PMMA/PC视窗、板材3D装饰镜片、板材3D大曲面装饰件,IML件产品于一体的企业。公司产品服务于手机、VR、AR、医疗、美容仪、家电、3C电子产品上。拥有一批从事视窗、镜片、铭牌及高压成型技术及销售人员。良好的软硬件环境和精诚团结的员工队伍。公司自成立以来,先后通过了ISO9001和ISO14001体系认证,拥有自主知识产权多项,已成为工艺成熟、体系健全的企业。

**主要展品 /Products**

公司产品服务于手机、VR、AR、医疗、美容仪、家电、3C电子产品上。拥有一批从事视窗、镜片、铭牌等塑胶装饰件及结构件。

**东莞慧迪智能科技有限公司****W1-1B53****Dongguan Huidi Intelligent Technology Co.,Ltd**

地址: 广东省东莞市长安镇角上角上兴路旭宇路1号2栋7楼  
Add: 1 Xuyu Road, Shangxing Road, Chang'an Town, Dongguan City,  
Guangdong Province, China.  
电话 /Tel: 0769-81557709

东莞慧迪智能科技有限公司成立于2017年,一直致力于智能家居清洁机器人的研发、生产和销售。2018年,随着首款擦窗机器人的推出,慧迪科技踏入了新的里程碑。随着研发的提升,慧迪科技在智能清洁领域的接受度和销售方面取得了突破性进展。

Dongguan Huidi Intelligent Technology Co., Ltd. was founded in 2017 and has been committed to the research and development, production and sales of home appliances. Huidi is with strong independent R&D and innovation capabilities, formed by an extensive team of professional who are passionate about robotics and AI, including 10 more engineers. Huidi has obtained a number of invention patents.

**主要展品 /Products**

智能擦窗机器人  
smart window cleaning robot



金坤磁铁

**东莞金坤新材料股份有限公司****W2-2A45****Dongguan Jiconn New Material Holdings Co.,Ltd**

地址: 广东省东莞市道滘镇小河工业区 (522300)  
电话 /Tel: 0769-85642967  
传真 /Fax: 0769-85642967

东莞金坤新材料股份有限公司是一家集研发、生产、销售为一体的稀土磁铁制造及应用方案服务商新三板上市企业(股票代码: 838939),拥有丰富的磁性材料行业研发、制造经验和完善的供应链体系,工厂位于东莞市道滘镇小河工业区,立足珠三角,服务全国和全世界客户。

**主要展品 /Products**

钕铁硼强磁

科立派净化  
KLP Corp.**东莞科立派净化科技有限公司****E2-2B22****Dongguan Kelipai Purification Technology Co.,Ltd**

地址: 东莞市东城街道狮长路1号1栋401  
电话 /Tel: 18617206938  
网址 /Web: <https://kelipai.en.alibaba.com/>

东莞科立派净化科技有限公司创建于2016年,坐落于有“世界工厂”之称的广东省东莞市。公司全面通过了ISO9001国际质量体系认证。

主营产品有: 初效滤网、中高效HEPA滤网、复合滤网、活性炭滤网、抗菌防霉滤网,工业袋式初中效过滤器以及大风量W型过滤器等等。

我们有专业的研发团队,可根据客户需求进行设计定制各类滤网;我们有完善的质量管理体系,确保产品高品质交付。

Dongguan Kelipai Purification Technology Co., Ltd., founded in 2016, is located in Dongguan City, Guangdong Province. The company has fully passed the ISO9001 international quality system certification.

The main products include: primary efficiency filter, medium efficiency HEPA filter, composite filter, activated carbon filter, antibacterial and mold proof filter, industrial bag type junior high efficiency filter, and high wind volume W-type filter. Mainly used in the air purifier industry, fresh air systems, central air conditioning, and ventilation and purification projects such as laboratories, dust-free workshops. The products have been sold in domestic and European markets. We have a professional research and development team that can design and customize various filters according to customer needs; We have a complete quality management system to ensure high-quality product delivery.

Looking forward to establish business relationship with your esteemed company.

**主要展品 /Products**

初效滤网、中高效 HEPA 滤网、复合滤网、活性炭滤网、抗菌防霉滤网, 工业袋式初中效过滤器, 大风量 W 型过滤器

Primary efficiency filter, medium efficiency HEPA filter, composite filter, activated carbon filter, antibacterial and mold proof filter, industrial bag type junior high efficiency filter, large air volume W-type filter

**东莞市龙基电子有限公司**  
**longkey electronic(Dongguan) co.,Ltd**
**W3-3A32**

地址: 广东省东莞市石龙信息产业园温泉南路 83 号 (523320)

Add: South Wenquan Rd No83 information industry complex Shilong Dongguan Guangdong China

电话 /Tel: 0769-81862666

传真 /Fax: 0769-81862611

网址 /Web: www.longkey-ptc.com

东莞市龙基电子有限公司成立于 1985 年, 生产 PTC 材料的专业厂家, 公司于 1995 年被广东省科委命名为“高新技术企业”。38 年来, 公司秉持着创新的理念, 致力于高效节能 PTC 电热元件的生产。拥有一批经验丰富的专业技术团队, 全套的自动化生产设备, 公司先后通过一系列 UL、SEMKO 和 CQC 等产品质量安全认证, 并通过 ISO9000 及 TS16949 系列质量管理体系认证, 拥有多项专利。

Dongguan Longkey Electronic Co., Ltd was established in 1985, The company has award High-tech Enterprise in 1995. In 1998, the company has changed to shareholding system of private enterprise from town-established collective enterprise.

All products passed various quality and safety certifications including UL, SEMKO and CQC, and has a number if patented technologies. In 1998, Longkey Company had been the first domestic counterparts enterprise that through ISO 9000 series of quality management system.

**主要展品 /Products**

波纹 PTC 发热器、钢化玻璃发热基板、薄层软性发热板、复合树脂发热基板、云母发热基板、美容美发 PTC 加热器、PTC 液体加热器、铝壳 PTC 加热器、新能源汽车 PTC 加热器、新能源汽车电池及加热配件、MMH 厚膜加热器

PTC fan heater, Toughened glass heating panel, Thin layer soft heating plate (metal film heater)

Composite resin heating panel/Mica heating panel (carbon film heater) Beauty care PTC heating element PTC water heater PTC aluminum house heater New energy automobile PTC heater

New energy automobile battery heat insulation parts MMH thick film heater

**东莞市爱迪机电科技有限公司**  
**Dongguan ET Mechanical & Electrical Technology Co., LTD**
**E1-1B44 1B45**

地址: 广东省东莞市东城街道龙华路 28 号 (523118)

Add: 28, Longhua Road, Zhouwu, Dongcheng District, Dongguan City,  
Guangdong Province, China

电话 /Tel: 0769-22031222

传真 /Fax: 0769-22034222

网址 /Web: www.etpump.cn

东莞市爱迪机电科技有限公司是一家专业设计、制造、销售微型泵的生产厂家。

目前, 爱迪科技拥有微型泵设计行业 10 年以上的开发队伍, 为客户量身定做各类微型泵产品。我们的无刷直流水泵, 微型隔膜泵, 微型电磁泵产品多个系列, 几十种规格。广泛应用于: 各大日常设备、太阳能设备、灌溉系统等自动化领域。

推行质量管理体系。坚持遵守环保、安全法规, 制造安全产品。

我们不断的优化整合公司资源, 努力为客户提供更好的产品。

Dongguan Aidi Electromechanical Technology Co., Ltd. is a professional design, manufacturing, sales of micro pump manufacturers.

At present, Aidi technology has more than 10 years of micro pump design industry development team, tailored for customers of all kinds of micro pump products. Our brushless DC pump, micro diaphragm pump and solenoid pump have multiple series and dozens of specifications. Widely used in: major daily equipment, solar energy equipment, irrigation system and other automation fields.

Implement quality management system. Adhere to environmental protection and safety regulations and manufacture safety products.

We constantly optimize and integrate the resources and strive to provide customers with better products.

**主要展品 /Products**

无刷直流水泵使用永磁无刷直流电机的原理, 转子加上叶轮, 外壳设计为液体流动的腔体结构, 无碳刷摩擦。特点是安全高效, 低功耗。较有刷电机寿命长, 噪音低。

微型隔膜泵又叫微型真空泵、微型水汽两用泵, 内部通过机械装置使泵内部的隔膜做往复运动, 并且在进口处能够持续形成真空或负压, 出口处形成微正压。

电磁泵是利用磁场和电流相互作用, 电流通过电磁绕组, 形成交变固定磁场, 推动柱塞往覆运动, 产生压力, 推动流体输出。

Brushless DC pump using the principles of permanent magnet brushless DC motor, coupled with an impeller on its rotor, the housing structure is designed to constitute a cavity fluid flow, no carbon brush friction. It is characterized by safety, high efficiency and low power consumption. Compared with brush motor, this kind of pump has longer lifepan and lower noise.

Micro diaphragm pump refers to vacuum pump and is also called micro water-air pump, through the mechanical device to make the diaphragm reciprocating movement inside the pump, and it can continuous from vacuum or negative at the inlet and from the micro positive pressure at the outlet. Electromagnetic pump is to use the interaction of magnetic fields and currents, the current through the solenoid coil, forming a fixed alternating magnetic field, push the plunger to cover sports, resulting in pressure to promote fluid output.



### 东莞市宝人电器科技有限公司

W1-1B15

地址: 东莞市大朗镇求富路社区牛过路 138 号宝人电器 7 栋

电话 /Tel: 0769-88602820

网址 /Web: www.baren777.com

东莞市宝人电器科技有限公司, 位于广东省东莞市松山湖畔大朗镇, 自 2001 年创建以来, 只专注于空气净化器, 空气净化加湿器产品的研发, 制造和销售。我们的理念是: 只有专一, 才能专心, 唯有专注, 才能专业。我们是中国高新技术企业, 也是“中国信用企业”示范单位。企业通过了 ISO9001 质量体系认证。并由 SGS, made-in-china 认证为全球合格供应商。

#### 主要展品 /Products

空气净化器



### 东莞市倍增电子有限公司

E1-1A37

Analog Power Electronic Co., Ltd

地址: 东莞市横沥镇隔坑下车岗聚龙路 6 号

电话 /Tel: 0769-83733396

东莞市倍增电子有限公司隶属港奇集团总部, 成立于 2004 年 4 月, 位于东莞市横沥镇。工厂面积约 12000 平方米, 2 条完整 AI、SMT 线, 日产能 AI 70 万点左右, SMT 180 万点左右, 12 条插件、组装、包装一体电源生产线, 月产能 450 万台左右, 公司员工约 750 人, 主要以研发、生产、销售各类开关电源适配器、智能充电器、以太网安防电源、智能家居电源、电动工具电源、车载电源、通讯电源、新能源汽车电源。

Group headquarters - Dongguan Analog Electronics Co., Ltd. was established in April 2004 and is located in Hengli Town, Dongguan City. Factory area: about 12,000 square meters, the company employs about 3600 people, the group has 10 power companies, a total area of 66,000 square meters, the total number of employees 3600 people. Mainly to research and development, production, sales of various types of switching power adapters, chargers, car power, communications power supplies and other products, mainly covers Netcom, multimedia audio, smart wear, LED lighting, large / small appliances, humidifiers, POS machines, POE switches In the market of new energy vehicles, etc., the power range of the adapter products covers 3-240W, and the power of custom-made power supplies is mainly within 3KW.

#### 主要展品 /Products

各类开关电源适配器、智能充电器、以太网安防电源、智能家居电源、电动工具电源、车载电源、通讯电源、新能源汽车电源等领域产品

production, sales of various types of switching power adapters, chargers, car power, communications power supplies and other products, mainly covers Netcom, multimedia audio, smart wear,



本末科技

### 东莞市本末科技有限公司

W2-2A13

directdrivetech

地址: 广东省东莞市松山湖高新技术产业开发区怡乐路一号中集产城数字科技产业园南区三号楼二层 (523830)

Add: No. 206, 207, 208, 2nd Floor, Building 3, South District, Digital Technology Industrial Park, CIMC Industrial City, No. 1, Yile Road, Songshan Lake High-tech Development Zone, Dongguan, Guangdong Province, China

电话 /Tel: 13632786501

传真 /Fax: 13632786501

网址 /Web: DIRECTDRIVE.COM

直驱型精准动力专家本末科技致力于使用直驱技术, 去除任何机器中的减速器, 使得原本娇贵、吵闹、低效、笨重的传统机器脱胎换骨。本末拥有机器人关节方面从传感器、驱动器到电机本体的全套设计生产技术, 同时独特的直驱方案也为众多行业提供了与传统减速器方案差异化的产品选择。目前, 本末科技的产品主要服务于家用机器人、工 / 商用机器人、健身行业等若干领域。

Direct Drive Technology is committed to using direct drive actuators to replace the reduction gears in any machine, making the original delicate and noisy traditional robot reborn. We have a complete set of technologies for robot joints from sensors, drivers to motor bodies. Various choices are enabled by the unique direct drive solutions, providing outstanding performance. So far, Direct Drive Tech mainly focus on home care robot, AGV/AMR, Gym facilities industry, etc. Direct Drive Tech using unique direct drive precise & powerful motion solution, thereby dedicated to help many other industries to boost different products.

#### 主要展品 /Products

M06 列电机是一款由东莞市本末科技有限公司自主研发的产品。该产品是基于一体化开发理念, 集外转子无刷电机、编码器、伺服驱动于一体的高可靠性永磁同步电动机, 其具有结构紧凑, 安装方便, 运行稳定, 小体积、大扭矩等优点。



### 东莞市灿途精密模具有限公司

E3-3B20

E G Enterprise Limited

地址: 东莞市长安镇荣富路 37 号 1 号楼 202

电话 /Tel: 0769-86289010

网址 /Web: www.egenterprise.asia

东莞市灿途精密模具有限公司坐落于世界模具之都——东莞市长安镇, 专注于注塑模具加工、注塑加工、五金零件加工等。我们拥有丰富的行业经验, 科学的管理体系, 合理的加工流程, 先进的生产及检测设备, 客户至上的服务理念。多年来, 我们的产品及服务赢得了海内外客户的一致好评。

产品远销世界各地, 如德国、法国、英国、波兰、意大利、瑞士、捷克、澳大利亚、美国、墨西哥等

E G Enterprise Limited (Dongguan Chantu Precision Mould Co., Ltd) is located in the "mould town



of the world"----Chang'an Town, Dongguan, specializing in injection mould, injection moulding, CNC metal machining. Thanks to our rich field-experiences, scientific management systems, reasonable production process, first-rate facilities for production and quality control, "customer-first" service concept, we've been recognized as an ideal partner domestically and abroad.

Our products are widely exported to many districts around the world such as Germany, France, UK, Poland, Italy, Switzerland, Czech, Australia, USA, Mexico, etc.

RFQ@egtooling.com / info@egenterprise.asia

#### 主要展品 /Products

模具、五金零件、塑胶零件

Injection Molds, Molded Plastic Parts, CNC machined Metal Parts.



#### 东莞市成东电子科技有限公司

W4-4B35

#### THE DONGGUAN CHENG DONG ELECTRONIC TECHNOLOGY CO., LTD

地址: 广东省东莞市东城区 东城街道桑园工业区狮长路 25 号成东电子科技有限公司

Add: No. 25, Shichang Road, sangyuan Industrial Zone, Dongcheng Street, Dongguan

电话 /Tel: 13168912719

传真 /Fax: +86 769 23836283

网址 /Web: www.cdelectronics.cn

我公司成立于 2007 年, 随后发展为两个兄弟公司: 东莞市成东电子科技有限公司和中山市万东电子科技有限公司。

多年来, 为许多国外客户提供了生产解决方案, 为我们的 "CDSPC" 品牌赢得了良好的声誉。

我们的金属化薄膜电容器系列产品, 包括 CBB、CL、X2 安规系列, 已被广泛应用于 LED 灯泡、LED 驱动器、电源适配器等电子领域。

我们始终把客户的满意作为目标, 如果您有任何问题, 请毫不犹豫地联系我们。

Our company was established in 2007 and then developed into two brother companies: Dongguan Chengdong Electronic Technology Co.,Ltd and Zhongshan WanDong Electronic Technology Co.,Ltd.

Over the passing years, we has offered production solutions for many foreign customers and won a good reputation for our brand "CDSPC".

Our metallized film capacitor series products, including CBB, CL, X2 Safety Regulation series, have been widely used in the electronic fields such as Led bulbs, led driver, power adapter etc.

We always take customer satisfaction as our goal and please don't hesitate to contact us if you have any question.

#### 主要展品 /Products

1. CDSPC 品牌 -CBB21/22 系列产品
2. CDSPC 品牌 -CBB81 系列产品
3. CDSPC Brand-CL 系列产品
4. CDSPC 品牌 -X2 系列产品

1. CDSPC Brand-CBB21/22 Series products
2. CDSPC Brand-CBB81 Series products
3. CDSPC Brand-CL Series products
4. CDSPC Brand-X2 Series products



#### 东莞市诚润电子科技有限公司

W1-1A06

#### DONG GUAN CHEVRON ELECTRONIC TECHNOLOGY CO.,LTD

地址: 东莞市厚街镇宝屯社区宝宏路鼎昊高科技产业园 D 栋 2 楼

电话 /Tel: 0769-85828868

东莞市诚润电子科技有限公司是集研发生产, 销售保护元器件的制造商, 公司成立于 2010 年, 厂房 5000 平方, 与韩国 多家保险丝代工, 产品分贴片, 塑封, 玻璃陶瓷管和自恢复保险丝. 应用电源, 灯具家电通讯等工厂, 通过 UL VDE CQC PSE KC 认证, 获 ISO9001:2015 和 ISO14001: 2015 认证符合 RoHS, REACH, HF 要求, 完善管理系统为客户提供最佳品质, 交期, 服务。

东莞市诚润电子科技有限公司是集研发, 生产, 销售于一体的过流保护元器件的制造商, 公司成立于 2004 年, 前身为东莞市厚街弘展电子厂, 目前厂房面积 5000 平方, 同时与韩国 中国多家国际一线保险丝品牌代工, 目前产品线分为一次性保险丝, (一次性贴片系列, 方形塑封系列, 玻璃管系列, 陶瓷管系列) 和自恢复保险丝 (贴片系列 插件系列 电池片系列) 产品主要应用电源适配器, 开关电源, LED 驱动, LED 灯具家电行业, 通讯产品, 安防产品, 电子设备, 电动玩具等领域工厂产品通过了美国 UL 德国 VDE 中国 CQC 日本 PSE 韩国 KC 等安规认证, 确保了产品的安全可靠, 公司已获得 ISO9001:2015 质量管理体系认证和 ISO14001: 2015 环保管理体系认证, 确保产品品质的一致性, 产品符合 RoHS, REACH, HF 要求, 依靠完善的精益生产管理系统, 全自动及半自动设备生产线, 完善的测试实验室, 和检测中心, 持续改善, 不断发展, 创新, 高效的管理理念, 为客户提供最佳的品质, 最具竞争力的价格, 最快的交期, 最好的服务。

#### 主要展品 /Products

产品线分为一次性保险丝, (一次性 0603 2410 1032 1245) 贴片系列, 方形塑封 SET SST 系列, 玻璃管 3.6\*10 5\*20 6\*30 系列, 陶瓷管 3.6\*10 5\*20 6\*32 系列) 和自恢复保险丝贴片 1812 2920 1210 1206 系列 插件系列 电池片系列



#### 创明电池

#### 东莞市创明电池技术有限公司

N3-3C95

#### DongGuan Cham Battery Technology Co.,Ltd.

地址: 广东省东莞市松山湖园区工业西三路 9 号 (523808)

Add: No.9, GongYe West No.3 road, Songshan Lake, DongGuan, 523808

电话 /Tel: 86-0769-23836666

传真 /Fax: 86-0769-23076581

网址 /Web: www.cham.com.cn

创明电池成立于 2003 年, 自成立以来一直专注于圆柱形锂电池的研发、制造和销售, 产品广泛应用于智能装备、绿色出行、储能系统等领域。主要生产基地位于广深港澳科技创新走廊的核心创新平台——松山湖国家级高新产业园区, 拥有员工近 1000 人。

创明电池是国内大容量圆柱电池的领跑者, 核心研发团队不断攻克国内技术瓶颈, 实现了 6 次容量突破。创明电池, 以绿色能源科技构建无线智能生活, 在互联网经济时代做出“芯”贡献。

CHAM Battery leads the industry in the design, manufacturing and sales of cylindrical lithium battery to smart home appliances, electric vehicles, two-wheelers and ESS industries.

We are one of the pioneers stepping into Lithium industry in China since its establishment in 2003.

We headquarter at Dongguan, Guangdong, with 40,000 m<sup>2</sup> self-owned land. CHAM has got certified by ISO9001, IATF16949, ISO14001, ISO45001, PSE, IEC,UL, CE, FCC, RoHS, UN, BIS. CHAM implements advanced automatic production machines and MES system to guarantee the consistency and reliability of battery. A comprehensive aging, grouping and inspection before shipment makes our battery meet the standard of highly demanded regions like Japan, USA and some European countries.

We are now the long-term supplier of some well-known brands in China and have built plenty projects with clients in Japan, USA, India and some European countries. 20 years of efforts in this filed enables CHAM ranks as a global leading lithium brand.

#### 主要展品 /Products

创明电池主要生产 18650、21700、32140 系列圆柱锂电池以及 PACK 产品,产品广泛应用于智能装备、储能系统、绿色出行。

容量电池主打产品为 2600 和 3350mAh,其中 3350mAh 高容量电池,性能媲美日韩电芯。

动力电池主打产品为 2500 和 2600mAh,也是国内首家量产 18650-3500mAh 电芯的厂家。

创明可批量生产各类 PACK 电池组,从 9W-300KW 均有广阔市场应用。

CHAM BATTERY specializes in manufacturing cylindrical Li-ion batteries including 18650, 21700, 32140 and PACK products, which are widely used in smart home, consumer electronics, energy storage, electric vehicles, cordless tools etc.

In the capacity cell field, CHAM has been walking in the forefront of the industry. The main products are 18650-2600mAh and 3350mAh, among which 3350mAh has comparable performance to international advanced level.

In the field of power cell, the main products are 18650-2600mAh, 2500mAh. CHAM is also the first domestic cell manufacturer launching 18650-3500mah cell.

CHAM can mass produce all kinds battery PACK products range from 9W-300KW.



#### 东莞市东颂电子有限公司

#### DONGGUAN DONGSONG ELECTRONIC CO., LTD

地址: 东莞市东城区柏洲边新田街 19 号 (523000)

Add: NO 19, Xintian Street, Baizhoubian, East District, Dongguan

电话 /Tel: 076922288970

网址 /Web: www.dys-cn.com

东颂电子集团总部位于东莞松山湖科技产业园,拥有东莞东颂电子、岳阳东颂电子、越南东颂电子、香港东颂国际四家子公司,是一家专业生产内置开关电源、电源适配器、充电器、高频变压器、专业音响电源等产品的高端电源制造商,提供研发、生产、销售、服务一体化解决方案。现已拥有东莞东城、岳阳华容高新区、越南胡志明新德工业区等三个现代化功能厂区。

With its headquarter located in the Songshan Lake Science and Technology Industrial Park of Dongguan, DYS group is a professional manufacturer of built-in open frame power supply, AC-DC power adapter, charger, high-frequency transformer, audio power supply etc., and also a integrated solution provider for R&D, production, sales and service. It has four subsidiaries: Dongguan Dongsong Electronic, Yueyang Dongsong Electronic, Dongsong Electronic Vietnam and DYS International HongKong. Over 20 years of accumulation and deliberation have created

DYS's current blueprint. Now DYS group has three modern functional factories which is in Dongguan Dongcheng, Yueyang Huarong High-tech Zone, and Vietnam HoChiminh Xinde Industrial Park. There are four production plants for switching mode power supply, high frequency transformer, power cable and injection molding.

#### 主要展品 /Products

ITE, 音视频类电源适配器, 小家电电源适配器, 充电器, 医疗电源, 防水电源, 裸板电源  
ITE, audio power adapters, home appliances power adapters, chargers, medical power supplies, waterproof power supplies, open frame power supplies



#### 东莞市凡睿电子科技有限公司

#### DONGGUAN FAN RUI ELECTRONICS&TECHNOLOGY CO.LTD

地址: 广东省东莞市茶山镇京山第三工业区二路 3 号 (523378)

Add: No. 3, 2nd Road, Jingshan third industrial zone, Chashan Town, Dongguan City, Guangdong Province

电话 /Tel: 0769-86866001

传真 /Fax: 0769-82991458

网址 /Web: http://www.dgfanrui.com

东莞市凡睿电子科技有限公司,专业编码器、电位器、多路开关、智能家居模块设计、制造、生产销售厂商。产品应用于汽车电子、多媒体、调音台、家用电器等、产品行销国内外。

公司通过 ISO9001 国际质量体系、ISO14001 的环境管理体系、IATF16949 质量管理认证。公司内部全面推行流程化、标准化运行作业,专业的设备为我们的产品提供了精确有效的品质保障系统。视品质为“凡睿”命脉是我们共同的企业价值观。

Dongguan fanrui Electronic Technology Co., Ltd., established in 2009, is a professional manufacturer of encoder, potentiometer, multi-channel switch and smart home module design, manufacturing, production and sales. The products are widely used in automotive electronics, multimedia, mixer, walkie talkie, electronic toys, household appliances, 3C field and industrial equipment, all of which meet the requirements of RoHS and reach environmental protection standards.

The company has passed ISO9001 international quality system, ISO14001 environmental management system and iatf16949 quality management certification. The company fully implements process, standardized and institutionalized operation, links to various departments and processes, and adopts advanced test equipment and testing equipment. Professional equipment provides an accurate and effective quality assurance system for our products. Regarding quality as the lifeblood of "fanrui" is our common enterprise value

#### 主要展品 /Products

智能屏模组, 编码器, 电位器, 波段开关, 传感器, 五金零部件, 塑胶零部件等  
Smart screen module, encoder, potentiometer, band switch, sensor, hardware parts, plastic parts, etc

W4-4A50

W3-3A15



**东莞市福恩电子有限公司**  
**DONGGUAN FUEN ELECTRONICS CO.,LTD.**

**W2-2B02**

地址: 东莞市常平镇苏坑上下付路 36 号  
电话 /Tel: 13318458112  
网址 /Web: www.fuen-sensors.com

东莞市福恩电子有限公司专业设计制造各种规格尺寸的浮球开关, 连杆浮球液位开关, 接近开关, 温度传感器, 浮球, 水流开关, 高压干簧继电器等系列产品。我们的产品广泛应用于汽车、船舶、小家电如饮水机, 咖啡机以及安防、运动器材、测试测量、医疗、轻化工等行业领域的产品中。福恩公司多年累积起来的丰富产品经验和专业技术, 给客户id提供高品质的标准产品, 还可根据客户具体需求和产品应用进行特殊产品开发。欢迎来电咨询。

Dongguan Fuen Electronics Co., Ltd. specializes in the design and manufacture of various specifications and sizes of float switches, connecting rod float level switches, proximity switches, temperature sensors, floats, water flow switches, high-voltage reed relays and other products. Our products are widely used in automobiles, ships, small household appliances such as water dispensers, coffee machines, security, sports equipment, test and measurement, medical, light chemical and other industries. The rich product experience and professional technology accumulated by Fuen Company over the years provide customers with high-quality standard products, and can also develop special products according to customers' specific needs and product applications. Welcome to inquire.

**主要展品 /Products**

浮球开关, 连杆浮球液位开关, 接近开关, 温度传感器, 浮球, 水流开关, 高压干簧继电器  
Float switch, connecting rod float level switch, proximity switch, temperature sensor, float ball, water flow switch, high voltage reed relay



**东莞市国研电热材料有限公司**  
**Key Material Co.,Ltd.**

**W5-5A40**

地址: 广东省东莞市常平镇司马村工业区门前路 8 号 (523570)  
Add: Sima Industrial Area, Changping Town, Dongguan City, Guangdong Province, China 523570  
电话 /Tel: 0769-82207178  
网址 /Web: www.kymch.com

东莞市国研电热材料有限公司成立于 2007 年, 是一家专注于金属陶瓷发热体研发, 生产, 销售的高新科技产业。我们是国内主要生产金属陶瓷发热体 (MCH) 的生产厂家。

我们注重产品研发, 与科研院所及高校紧密合作, 拥有强大的技术开发能力和技术团队。

公司拥有 113 项产品专利, 其中发明型专利 17 项, 国外专利 7 项。

公司愿景和宗旨: 成为中国陶瓷发热体的领导者, 成为涉足领域细分市场第一名, 为客户提供关键价值。

**主要展品 /Products**

智能坐便器用陶瓷加热体、饮水机用陶瓷加热体、即热式水龙头 / 电热水器用陶瓷加热体 / 美发器用陶瓷加热体、香薰器 / 灭蚊器用陶瓷发热体、恒温浴缸用陶瓷发热体、足浴盆用陶瓷发热体等。



**东莞市恒迅微型电机有限公司**  
**DongGuan HengXun Micro Motor Co., Ltd.**

**E3-3B06**

地址: 广东省东莞市桥头镇石水口银河一路 5 号  
Add: 5 Shishuikou Yinhe Yi Road, Qiaotou Town, Dongguan City, Guangdong Province  
电话 /Tel: 0769-83564333  
网址 /Web: http://www.hengxunmotor.com

东莞市恒迅微型电机有限公司成立于 2003 年, 是一家专业从事微型电机设计研发、生产、销售和服 务于一体的国家高新技术企业。主要生产微型直流电机、无刷电机、齿轮减速箱以及新能源电机等。产品广泛应用于智能家居、个人护理、安防监控设备、小精品家电、医疗器械、电动工具、视听产品、机器人、无人机、汽车部件、办公设备、净化器、新能源等领域。

DongGuan HengXun Micro Motor Co., Ltd. was founded in 2003, is a National High-tech enterprise specializing in the Research and Development, production, sales and service of micro motors. It mainly produces miniature DC motors, Brushless motors, Gear reduction boxes and new energy motors, etc. Products are widely used in smart home, personal cares, security monitoring equipments, small and fine household appliances, medical devices, electric tools, audio-visual products, robots, drones, automobile parts, office equipment, purifiers, new energy and other fields.

The company is located in Hengxun Industrial Park, Qiaotou Town, Dongguan City, Guangdong Province, covering an area of more than 10,000 square meters, with beautiful environment and convenient transportation.

**主要展品 /Products**

有刷、无刷、新能源电机: 智能家居电机、安防监控设备电机、小精品家电电机、医疗器械电机、电动工具电机、视听产品电机、机器人电机、无人机电机、汽车部件、办公设备电机。

Brushless, new energy motor: smart home motor, security monitoring equipment motor, small boutique electrical appliances motor, medical equipment motor, power tools motor, audio-visual products motor, robot motor, uav motor, car parts, office equipment motor.

## 宏源净化 ONGYUAN

东莞市宏源净化设备有限公司

Dongguan Hongyuan Purification Equipment Co., Ltd.

W1-1A45

地址: 广东省东莞市黄江镇金钱岭五街5号B-2栋2楼

Add: 2nd Floor, Building B-2, No. 5, Qianqianling Fifth Street, Huangjiang Town, Dongguan City, Guangdong Province

电话 /Tel: 13829133536

传真 /Fax: 0769-83848079

网址 /Web: www.goodhepa.com

东莞市宏源净化设备有限公司成立于2007年,是专注于空气净化器以及空气净化器滤芯配件等产品的研发与制造的工厂,拥有自主设计、研发、开模核心技术,现拥有多项实用和外观核心专利,能够为广大客户提供空气过滤洁净技术解决方案!

Dongguan Hongyuan Purification Equipment Co., Ltd., established in 2007, is a factory specializing in the research, development and manufacturing of air purifiers and filter element accessories for air purifiers. It has independent design, research and development, mold opening core technology, and now has a number of practical and appearance core patents, which can provide customers with air filtration cleaning technology solutions!

### 主要展品 /Products

HY1800 WX 空气净化器、HY1800 PRO 空气净化器、HY1800 JS 空气净化器、HY4866 空气净化器、HY1800 空气净化器、HY3800 空气净化器、HY1637 空气净化器、HY-1101 冰箱除味器、桶形 HEPA 滤网、活性炭滤网、矩形 HEPA 滤网、夹炭布滤网、光触媒滤网、冷触媒滤网、除臭臭氧网、除 PM2.5 汽车空气滤网。

HY1800 WX air purifier, HY1800 PRO air purifier, HY1800 JS air purifier, HY4866 air purifier, HY1800 air purifier, HY3800 air purifier, HY1637 air purifier, HY-1101 refrigerator deodorizer, bucket shaped HEPA filter screen, activated carbon filter screen, rectangular HEPA filter screen, carbon cloth filter screen, photocatalyst filter screen, cold catalyst filter screen, ozone removal filter screen, and PM2.5 automotive air filter screen.



HUASHENGYI

东莞市华生益环保净化科技有限公司

Dongguan Walsen Environmental Purifying Technology Co., Ltd.

E1-1C94

地址: 东莞市东城区莞元新路113号

Add: No. 113, Anyuanxin Road, Wentang, Dongcheng District, Dongguan City

电话 /Tel: 15999727857

网址 /Web: http://airfiltrationcn.com

东莞市华生益环保净化科技有限公司,是一家专业从事空气过滤网研发、生产和销售的厂家。公司成立于2013年11月,月生产产能15~20万片滤网。

设施上,公司配套了无尘生产车间、先进生产设备、风洞测试系统、滤料检测台、81立方测试舱,

30立方固态和气态测试舱、3立方固态和气态测试舱、8立方检测舱、1立方的臭氧测试舱等。

公司有专业的研发团队,可根据客户的要求或者来样设计订制各类过滤器,欢迎洽谈。

Founded in Nov, 2013, Dongguan HUASHENGYI Environmental Purification Technology Co., Ltd is a company focusing on air filter products development, manufacturing and sales. With monthly airfilter output 150,000 ~ 200,000 pcs.

On facility wise, we have set up clean workshop with advanced production facility and quality checking facility including wind tunnel testing system, filtering material tester, 30m<sup>3</sup> particle and gaseous testing cabin, 3m<sup>3</sup> aging testing chamber and 8m<sup>3</sup> & 1m<sup>3</sup> odor testing chamber.

We own a professional R&D team to design different kinds of filters according to customers' requirement or samples. Looking forward to your enquiring.

### 主要展品 /Products

公司主营三类过滤网: 第一类, 固态颗粒物过滤网, 效率从G1—H14; 第二类, 气态污染物过滤网, 可处理甲醛、甲苯、氨、硫化物、TVOC、臭氧等异味; 第三类, 抗菌抗病毒过滤网。产品用于民用净化器、新风系统、中央空调回风口、汽车空调系统、特殊工业通风系统。

We mainly produces and supplies 3 types airfilters. 1, Particle aidfilters, with filtering efficiency from G1-G14. 2, Gaseous pollution airfilters. To filter smell like formaldehyde, Toluene, ammonia, sulfide, TVOC, ozone etc. 3, Antibacterial and antiviral filters. The filters are used in household purifier, new air system, central air-conditioning inlet, auto air-conditioning system and special industrial venting system.



东莞市精锋智能玻璃有限公司

Dongguan Jimfuk Smart Glass Company Limited

W1-1B01

地址: 广东省东莞市横沥镇裕宁北路13号1号楼101室(523460)

Add: Room 101, Building 1, 13 YuNing North Road, Hengli Town, Dongguan City, Guangdong Province.

电话 /Tel: 0769-82306289

传真 /Fax: 0769-82306289-802

东莞市精锋智能玻璃有限公司创建于2012年,是一家集玻璃工艺研发、生产、销售于一体的综合型深加工企业。专业生产光学玻璃镜片,汽车后视镜,电子电器玻璃面板,开关插座面板,潜水镜,钢化玻璃,AR/AG玻璃,玻璃丝印等。产品广泛应用于汽车、电子、电器、数码等各大行业,远销欧美,东南亚,及全球市场。公司坚持以“品质第一,客户至上”的生存理念,打造安全、高效、优质、节能的生产加工办法,超越客户期望。

### 主要展品 /Products

专业生产光学玻璃镜片,镀膜玻璃,汽车后视镜,电子电器玻璃面板,触摸控制玻璃面板,开关插座面板,显示屏盖板,高精度精雕玻璃面板,灯饰玻璃,耐高温视镜,高硼硅玻璃,微晶玻璃,石英玻璃,近视潜水镜,平光潜水镜,光学手表玻璃,钢化玻璃,AR玻璃,AG玻璃,磨砂玻璃,蒙砂玻璃,玻璃丝印等。



JNŪO

净诺科技

东莞市净诺环境科技股份有限公司

E2-2B36 2B37

Dongguan JingNuo Environment Science and Technology Inc.

地址: 广东省东莞市凤岗镇竹塘村浸校塘利民路2号 (523682)

Add: #2 Limin Road, Jinxiaotang, Zhutang Village, Fenggang, Dongguan, Guangdong, P.R.China.

电话 /Tel: 0769-8190-0629

网址 /Web: www.jingnuoair.com

东莞市净诺环境科技股份有限公司是一家集研发, 制造, 销售于一体的国家级高新技术企业, 坐落于广东东莞。19年来专注研发制造高品质的空气净化器, 新风机, 加湿器, 烘鞋器等环境电器产品, 致力于为全球用户提供安全, 健康, 优质的家居环境电器解决方案。工厂通过 ISO9001 质量体系, ISO14001 环保体系, ISO45001 职业健康安全管理体系和 BSCI 社会责任等审核体系认证, 净诺有信心成为您值得信赖的商业伙伴。

Dongguan JingNuo is a professional Home Appliance Manufacturer located in Dongguan City, Guangdong Province. With 19 years' experience, Dongguan JingNuo develops Air Purifier, Humidifier, Heater, Boots Dryer, Air Ventilator, Vacuum Cleaner for customers all around the world. We have 60 talented R&D engineers, 60 experienced QC staffs, over 500 skilled workers. Our team provide strong technical support for our ODM and OEM services. The famous brands that we are serving include PHILIPS, Blueair, Germguardian, Holmes, Bionaire, Sunbeam, Honeywell, Alen, Hamilton Beach, SK Magic, HuaWei etc.

As an ISO9001, ISO14001, ISO45001, BSCI qualified factory, we are always supplying the reliable products to the whole world. Dongguan JingNuo is confident to be your win-win business partner.

**主要展品 /Products**

空气净化器, 加湿器, 暖风机, 烘鞋器, 新风机, 吸尘器

Air Purifier, Humidifier, Heater, Boots Dryer, Air Ventilator, Vacuum Cleaner

cnkalun

东莞市咖伦电子有限公司

N1-1A28

地址: 东莞市塘厦镇田心鹿苑路71号 (523710)

电话 /Tel: 0769-80287951

传真 /Fax: 0769-82087951

网址 /Web: www.cnkalun.com

本公司专业生产电磁泵, 电磁阀, 客户产品主要是胶囊咖啡机, 蒸汽清洗设备, 挂烫机, 油烟机, 舞台烟雾机等。

**主要展品 /Products**

微型电磁泵



东莞市康柔电器科技有限公司

E3-3C31

Dongguan KangRoad Electrical Technology Co., LTD

地址: 广东省东莞市谢岗镇金川工业区金铭路巨嘉工业园 (523590)

Add: JinChuan No.2 Rd, Jinchuan industrial Area, Xiegang Town, Dongguan City, Goangdong Province, China

电话 /Tel: 076987683518

传真 /Fax: 076987683538

网址 /Web: www.chinakangroad.com

东莞市康柔电器科技有限公司致力于打造中国高端个人护理品牌, 秉承不断探索, 突破自我的精神, 在创新科技、精湛工艺、美学设计等各方面不断创新, 与时俱进。为消费者带来高品质的个人健康护理产品与服务, 专业生产以电吹风、直发器、卷发器美容电器等为主导的时尚美容美发和健康个人护理产品。

Dongguan KangRoad Electrical Technology Co., Ltd. is committed to building a high quality and safety personal care brand in China, adhering to the spirit of continuous exploration and breakthrough, and constantly innovating in innovation, technology, exquisite craftsmanship, aesthetic design and other aspects, and keep pace with the times. Bringing high quality personal health care products and services to consumers. Specializing in the production of fashion hairdressing and health personal care products led by hair dryers, hair straighteners, hair curlers and beauty appliances.

**主要展品 /Products**

我司是专业生产直发器、卷发棒、吹风机, 产品具有极高的质量保障。企业通过 ISO-9001: 2015 质量管理体系认证, 产品先后获得德国 GS、欧盟 CE、美国 CETL、CB、SAA、C-TICK、日本 PSE 等国际认证, 拥有直营进出口权, 产品远销欧洲、美国、日本、韩国、东南亚等多个国家和地区, 建立了遍布全球的营销网络。

Our company specializes in the production of hair straighteners, curling irons, hair dryers, and the products have high quality assurance. The company has passed the ISO-9001:2015 quality management system certification. The products have obtained international certifications such as GS, CE, CETL, CB, SAA, C-TICK, PSE, etc., and have direct import and export rights. In the United States, Japan, South Korea, Southeast Asia and other countries and regions, a global marketing network has been established.

laifen徠芬

东莞市徠芬电子科技有限公司

W4-4G86

Dongguan Laifen Electronic Technology Co., Ltd.

地址: 广东省东莞市虎门镇宁江路14号1号楼 (523000)

Add: Dongguan City, Guangdong Province, Humen Town, Ningjiang Road, Building 14

电话 /Tel: 0755-86665249

传真 /Fax: 0755-86665249

网址 /Web: www.laifen.net

徠芬科技成立于2019年, 是一家专注于生活家电设计、研发和销售的科技创新品牌, 致力于让尖

端科技走进大众生活。秉承实干进取的工匠精神，在创新科技、精湛工艺、美学设计等各方面全力以赴，以超高性价比的产品和优质服务赢得广大用户的信赖。

公司拥有自主研发团队，旗下代表产品为高速吹风机，已申请 26 项外观及技术专利，。目前已入驻天猫、淘宝、京东、苏宁等数十个电商平台，在多个电商平台销售额均排名前三。

#### 主要展品 /Products

【快速吹干不烤干】

搭载 11 万转高速无刷马达，20.92m/s 实测风速，干发速度提升 100%。

【多重护发不掉发】

智能温控技术，1000 次 /s 监测风温；两亿高浓度负离子，中和静电抚平毛躁。

【轻巧便携，满足多种造型】

本机重量仅 407g，风筒缩短至 8.9cm，小巧精致，适合出差和短期旅行用户。



#### 东莞市联晟精密科技有限公司

**Dongguan Liansheng Precision Technology Co., Ltd**

地址：东莞市联晟精密科技有限公司 (523900)

Add: 3 Hongshan Road, Daning Community, Dongguan, Guangdong

电话 /Tel: 0769-85029809

传真 /Fax: 0769-85029809

东莞市联晟精密科技有限公司专业制作小家电模型、汽车模型、医疗产品模型，智能硬件等各  
领域产品应用模型。

厂房占地面积 7000 平方米，有 CNC 加工中心 35 台，170 名员工来自行业内经验丰富的技术人员。

公司拥有独立的钣金手板车间、CNC 车间、打磨抛光车间、表面处理车间及其它工序所需的配套  
设备，同时我们有严格的检测、试配流程。精密零件采用三次元测量。

Dongguan Liansheng Precision Technology Co., Ltd. specializes in the production of large and  
small household appliance models, automobile models, medical product models, intelligent  
hardware and other fields of product application models.

The factory covers an area of 7000 square meters, with 35 CNC machining centers and 170  
employees from experienced technicians in the industry.

The company has an independent sheet metal handboard workshop, CNC workshop, grinding  
and polishing workshop, surface treatment workshop and other processes required supporting  
equipment, and we have strict testing, trial matching process. Precision parts adopt CMM  
measurement.

#### 主要展品 /Products

塑胶 & 钣金等产品模型

Plastics & Alloys, sheet metal

**N4-4B19**



#### 东莞市联臻光电科技有限公司

**Lianzhen Optoelectronics Tech Co., Ltd**

地址：东莞市常平镇卢屋村工业区工业二路 2 号 (523000)

Add: No. 2, Gongye 2nd Road, Luwu Village Industrial Zone, Changping Town, Dongguan City

电话 /Tel: 13925774810

传真 /Fax: 0769-82207705

网址 /Web: www.chuinalianzhen.com

东莞市联臻光电科技是专业塑胶挤出押出、塑胶挤出模具，并通过 ISO 质量体系认证的生产性  
工厂，生产加工：塑胶挤出成型 PC 灯罩，ABS 塑胶管，HDPE、PP 卷芯管，保护模收卷管，PETG、  
PCTG 透明包装管，吸尘器地刷管，吸尘器软刮片，ABS+PC 合金塑胶隔条，PC 管，亚克力透明管，  
塑胶异形管、密封条，塑胶条，电器外壳配件，塑胶型材挤出，双色塑胶挤出，软硬塑胶挤出（押出）等，  
欢迎来电来图定制开模生产。

#### 主要展品 /Products

塑胶挤出成型 PC 灯罩，ABS 塑胶管，HDPE、PP 卷芯管，保护模收卷管，PETG、PCTG 透明包装管，  
吸尘器地刷管，吸尘器软刮片，ABS+PC 合金塑胶隔条，PC 管，亚克力透明管，塑胶异形管、密封条，  
塑胶条，电器外壳配件，塑胶型材挤出，双色塑胶挤出，软硬塑胶挤出（押出）。



#### 东莞市领亚智能科技有限公司

**Dongguan Linoya Intelligent Technology Co., Ltd**

地址：东莞市企石镇清湖工业区民营工业园 (523800)

电话 /Tel: 0769-8990-9399

传真 /Fax: 0769-8990-9399

网址 /Web: www.linoya.com

东莞领亚智能有限公司是领亚集团子公司，地处中国东莞企石镇，建筑占地面积约 5 万平方米，  
现有员工约 500 余人，其中专业工程人员 70 余人，品质人员 50 余人。主要产品为：AC 电源线、橡胶  
线、户外防水连接器、新能源线束、电动车接插件等。2021 年销售额 3.5 亿元，主要服务于小米、航嘉、  
Tip-Link、Midea、Gree、KONKA、TCL、SKY、Black&Decker、Beko、等国内外知名客户。

#### 主要展品 /Products

AC 电源线、橡胶线、户外防水连接器、新能源线束、电动车接插件。

**E1-1B31**

**E1-1B12**



**东莞市明盛电气有限公司 | 深圳市迈尔盛绝缘材料有限公司**  
**DONGGUAN MYSUN ELECTRIC CO., LTD**  
**/SHENZHEN MYSUN INSULATION MATERIALS CO., LTD**

**W2-2B37**

地址: 广东省东莞市厚街镇厚涌路 15-17 号 (523106)

Add: No.15-17,Houchong Road,Houjie Town,Dongguan,Guangdong,China.

电话 /Tel: 0769-81696155

传真 /Fax: 0769-81696133

网址 /Web: Http://www.szmymysun.com

深圳迈尔盛绝缘材料成立于 1999 年, 公司高级技术骨干 18 人, 拥有业内先进高温电线电缆生产设备。东莞明盛电气有限公司是迈尔盛全资控股子公司, 公司严格按照 ISO9001, ISO14001, IATF16949 管理体系运行, 产品通过 UL、cUL、VDE、CCC、TUV 认证, 为汽车、新能源、军工、家电、灯饰、医疗、船舶、新兴装修市场提供环保优质的电线电缆。

**主要展品 /Products**

高温电线电缆



**东莞市能博旺动力科技有限公司**  
**DongGuan Nengbowang Power Technology Co.,Ltd.**

**W1-1B47**

地址: 东莞市塘厦镇高于北路 118 号

电话 /Tel: 0769-82776088

网址 /Web: www.nbwmotor.com

东莞市能博旺动力有限公司专业从事各类直流无刷电机及齿轮箱传动系统的研发, 生产, 销售一体的高新技术企业。

公司产品主要用于医疗行业, 机械行业, 汽车行业, 智能家电, 机器人, 吸尘器行业。

公司拥有专业的资深机械研发团队和电子研发团队, 有严格完善的品质管理体系, 专业的售后服务客户至上的服务理念为导向, 用心做好每一台电机。

我们以专业的设计, 稳定的质量, 合理的价格, 快捷的交付, 真诚服务于每个客户!

Dongguan Nengbowang Power Technology Co.,Ltd.specializes in all kinds of Brushless DC motor, BLDC Digital Motor and Gearbox drivetrain design, development, manufacturing and sales in one of the high-tech enterprises.

we are mainly manufacturing high quality outer rotor brushless motor, inner rotor brushless motor and Precision drivetrain (gearbox), the product are mainly used in the medical industry, machinery industry, automotive, intelligent appliances, robotics industry and vacuum cleaner industry.

we have a professional senior mechanical R & D team and electronic R & D Team, we have strict and perfect quality management system, mature production system, professional after-sales service, we ensure the good quality and reliability of our product, we followed service concept of supremacy and we will do a good job in every product.

We offer professional design, stable quality, reasonable price, fast delivery and sincere service to every customer.

**主要展品 /Products**

直流无刷电机、BLDC 数码电机以及齿轮箱传动系统

Brushless DC motor, BLDC Digital Motor and Gearbox drivetrain



**东莞市欧斯凯健身器材科技有限公司**  
**Dongguan Osky Fitness Equipment Co., Ltd**

**W3-3H87**

地址: 广东省东莞市石排镇黄家堡升耀工业园 C 栋二楼 (523330)

Add: 2F, Building C, Shengyao Industrial Area, Huangjiabo Village, Shipai Town, Dongguan City, Guangdong province, China

电话 /Tel: 86652928

传真 /Fax: 86-769-86652929

“东莞市欧斯凯健身器材科技有限公司”坐落在东莞市石排镇。

"Shenzhen Jinyuan Sports Massage Equipment Co., Ltd." is an enterprise focusing on the research, development, production and sales of massage equipment for 20 years. The new factory "Dongguan OSK Fitness Equipment Technology Co., Ltd." is located in Shipai Town, Dongguan City.

Through continuous efforts in innovation and research and development, the company has obtained nearly 100 product practical, appearance, and invention patents, and has continuously improved and established a high-quality service system. Our company has always been an ISO9002:2000 quality management system certified company. Most of the products have passed CE, UL, ETL, PSE, SAA product certification; all product materials meet the international ROHS environmental protection requirements, and the products have been exported to more than 100 countries and regions such as Europe, the United States, Australia, the Middle East and Asia. The company mainly produces and sells "Homepro" branded products

**主要展品 /Products**

按摩器材

Massage product



**品佳**  
**PINJIA**  
**东莞市品佳智能科技有限公司**  
**Dongguan Pinjia Intelligent Technology Co.,Ltd.**

**E1-1D76**

地址: 广东省东莞市清溪镇振升路 11 号 1 号楼 301 室

Add: Room No.301, Building 1, No.1 Zhensheng Road, Qingxi Town, Dongguan City, Guangdong, China.

电话 /Tel: 07698890202

网址 /Web: www.pjrobot.com

东莞市佳智能科技有限公司专注于智能扫地机器人、家用吸尘器、便携式车载吸尘器、迷你桌面吸尘器、智能洗地机等高科技家居清洁产品的 OEM/ODM。

Dongguan Pinjia Intelligent Technology Co., Ltd focuses on research and development of high-tech home cleaning products including Robot Vacuum cleaners, Smart Air Purifiers. Portable Vacuum Cleaners, Car vacuums, and Mini Desktop vacuums. Our goal is to provide customers with unique designs, and high-quality and comprehensive services to achieve a win-win situation with customers.

The factory covers an area of 20000 square meters, has more than 350 employees, and has 12 production lines with an average monthly capacity of 200K units.

Welcome to Dongguan, China, Welcome to bring ODM/OEM projects to Pinjia!

#### 主要展品 /Products

专注 ODM/OEM 智能激光扫地机, 陀螺仪扫地机, 智能家用空气净化器, 无刷吸尘器, 便携式车载吸尘器, 迷你桌面吸尘器等

OEM/ODM LiDAR Robot Vacuum Cleaners, Advanced Gyro-Navigation Robot Vacuum Cleaners, Smart Air Purifiers, Brushless vacuum cleaners, Portable vacuum cleaners, Mini desktop Vacuum, etc...



#### 东莞市奇光电子有限公司 DONGGUAN SPAR ELECTRONIC CO., LTD.

W5-5C64

地址: 中堂镇东泊村二围路 15 号 (523230)

Add: No. 15, Erwei Road, Dongpo Village, Zhongtang Town, Dongguan, Guangdong, 523233, China

电话 /Tel: 86-0769-88182558-831

传真 /Fax: 85-0769-88189616

网址 /Web: www.dgspar.com

东莞市奇光电子有限公司, 成立于 2013 年, 我司从 2003 年开始从事丝印、烫金、CNC 加工近 20 年。主要服务于各行业的塑料视窗显示保护屏、触摸感应功能塑料盖板面贴、外观装饰塑胶贴片、塑胶指示标牌及亚克力工艺品、支付牌、展示架。加工材质包括亚克力 (PMMA)、PC、PET、五金、塑胶、3M 双面胶等。可来料加工, 定制加工。加工工艺包括: 丝网印刷、烫金加工、UV 打印 (彩印)、CNC 加工、模切成型。

Dongguan Spar Electron Co., Ltd.

A professional manufacturer based on acrylic, PC and PET plastic as raw materials. Applied to mobile payment terminals of various communication equipment, Electronic testing equipment, Window display lenses and exterior decoration/functional panels of smart homes and various electrical appliances. Processing technology: printing, hot stamping, packaging, CNC, mold punching, hot pressing, UV optical bonding, UV transfer, UV color printing, laser cutting and engraving, etc.

#### 主要展品 /Products

应用于各行业的视窗显示镜片和外观装饰 / 功能面板。包括家用电器亚克力 / PC/PET 塑料配件, 厨房

电器亚克力 / PC/PET 塑料配件, 安防监控行业亚克力 / PC/PET 塑料配件, 通信设备电气仪表亚克力 / PC/PET 塑料配件, 汽车交通亚克力 / PC/PET 塑料配件, 教育办公行业亚克力 / PC/PET 塑料配件, 广告游戏及支付行业亚克力 / PC/PET 塑料配件, 亚克力工艺品制作及来料加工印刷、烫金、CNC 加工。

Window display lenses and exterior decoration/functional panels used in various industries. Including household appliances, Kitchen Appliances, Security monitoring industry, Communication equipment electrical instrument, Car traffic, Education office industry, A

## VCRR

#### 东莞市乔顿电子有限公司 DONGGUAN JORDUN ELECTRONIC CO., LTD

N1-1B45

地址: 东莞市常平镇木伦工业一路 39-2 栋 4 楼

电话 /Tel: 13549347808

网址 /Web: www.jdvccr.com

成立于 2016 年, 是国内首家专业从事研发生产销售热保护型压敏电阻 (TMOV) 的高科技企业。拥有独立自主品牌“VCRR”并获得 UL, TUV 认证。公司从日本引进先进半导体工艺及设备, 多年来秉承“品质第一, 客户之上的原则”, 先后成为阳光、旭准股份、HP 等百余家国内外知名企业优秀供应商。

主要产品: 热保护压敏电阻 TMOV, TBMOV, 压敏电阻, 热敏电阻。TVS, 放电管, MOSFET。

Jordan Electronics Co., Ltd., founded in 2016, is the first high-tech enterprise specializing in the production, research and sales of thermal protection varistor TMOV in China. It has an independent brand "VCRR" and has obtained UL and TUV certification The company has imported advanced semiconductor technology and equipment from overseas, adhering to the principle of "quality first, customer first" for many years, and has become an excellent supplier of more than 100 well-known enterprises at home and abroad, such as ABB, Sunshine, XuZhun, HP, Electrolux, Midea, etc.

#### 主要展品 /Products

热保护压敏电阻 TMOV, 盒装热保护压敏电阻 (TBMOV), 常规压敏电阻, 防雷模组, 热敏电阻 NTC, TVS 瞬态抑制二极管, 陶瓷气体放电管 GDT, 半导体放电管 TSS, 玻璃放电管 SPG, MOSFET。

Thermal protected varistor (TMOV), TBMOV, Conventional varistor, GMOV, SPD type varistor, Thermistor (NTC), TVS, GDT, TSS, SPG, MOSFET.



深鹏电子

#### 东莞市深鹏电子有限公司 Dongguan Shenpeng Electronics Co., Ltd

N2-2B08

地址: 东莞市常平镇岗梓大埔工业区 (523571)

Add: Dapu Industrial Zone, Gangzi Village, Changping Town, Dongguan City

电话 /Tel: 0769-81868638

传真 /Fax: 0769-81868633

网址 /Web: http://www.dgshenpeng.com / http://www.shenpengpump.com



东莞市深鹏电子有限公司, 专业研发和生产直流无刷电子水泵, 建筑面积约 1.2 万 m<sup>2</sup>, 实验室通过 CNAS 标准认证, 同时通过长安汽车, 吉利汽车、上汽通用五菱汽车实验室审核认可。30 万级无尘车间, 10 多条电子水泵专业生产线, 全年可生产水泵 500 多万台, 潜在 300 万台产能, 是目前国内最具规模的直流无刷水泵生产基地之一。公司荣誉“广东省高新技术企业”、“国家级专精特新小巨人”、东莞市“倍增企业”等多项荣誉。

Dongguan Shenpeng Electronics Co., Ltd was found in 2004 and is specialized in brush-less DC water pumps. As a global BLDC water pump solutions specialist, it integrates R&D, manufacture with sales. The products are mainly applied to New-energy vehicle, mattress, home appliance (water heater, dish washer, coffee machine, water dispenser), smart toilet, cosmetic/medical equipment, machine tool equipment, air conditioning base station, PC, LED cooling system, aquarium etc.

Shenpeng was the earliest company that managed to produce the brushless DC water pumps. It is located in Changping, Dongguan and covers an area of 18000 m<sup>2</sup>. With an in-house CNAS standard laboratory, 300-thousand-grade dust-free workshop and 10 professional production lines. The annual production capacity is more than 5 million sets of water pumps and it is one of the largest manufacturer of BLDC water pump in China. It won many honorable titles such as High-tech Enterprise, Multiplication Enterprise etc.

#### 主要展品 /Products

专业研发和生产直流无刷电子水泵, 产品主要应用于: 新能源汽车、家用电器 (热水器、洗碗机、咖啡机、饮水机)、智能马桶、水暖床垫、冷水机、美容医疗设备、商用空调、储能空调、热泵等领域。

As a global BLDC water pump solutions specialist, it integrates R&D, manufacture with sales. The products are mainly applied to New-energy vehicle, mattress, home appliance (water heater, dish washer, coffee machine, water dispenser), smart toilet, cosmeti



#### 东莞市铄徕电子有限公司 DongGuan KingLion Electronics Co.,Ltd

W2-2B47

地址: 东莞市厚街镇桥头第三工业区国道东 9 号 (523950)

Add: Qiaotou third industrial zone No.9 East National Road, Houjie Town, Dongguan City

电话 /Tel: 0769-85080815

传真 /Fax: 0769-89129055

网址 /Web: <http://www.kingliongroup.com>

铄徕电子是一家绝缘材料的研究、开发、生产和销售集为一体的专业公司, 主要生产产品有: 伸缩编织网管、纯硅橡胶软管、氟塑胶制品、玻璃纤维套管、热收缩套管、PVC 套管、绝缘胶带、绝缘垫、尼龙扎带电器配件等各种绝缘材料, 广泛应用于电子、电力、电器、冶金、石化及航天航空领域。

为强化企业和产品质量, 符合 ISO9001: 2015 标准的质量认证体系, IATF16949 标准的汽车质量认证体系, 产品获得 UL 认证。

KingLion is a professional company integrating the research, development, production and sales of insulating materials. Its main products include: telescopic woven network management, pure silicone rubber hose, fluoroplastic products, glass fiber sleeve, heat shrinkable sleeve, PVC sleeve, insulating tape, insulating pad, nylon tie, electrical accessories and other insulating

materials, which are widely used in electronics, power, electrical appliances Metallurgical, petrochemical and aerospace fields.

In order to strengthen the enterprise and product quality, the products have obtained UL certification in accordance with the quality certification system of iso9001:2015 standard and the automobile quality certification system of iatf16949 standard.

#### 主要展品 /Products

热缩套管、硅胶管、纤维管、编织网管、PVC 套管、铁氟龙管、TPU 管、发泡管、内胶外纤、内纤外胶、波纹管、金属软管、金属编织管、黄腊管、尼龙束线带、闭端子、线扣、间隔柱等等

Heat shrinkable casing, silica gel pipe, fiber pipe, braided network management, PVC casing, Teflon pipe, TPU pipe, foam pipe, inner rubber and outer fiber, inner fiber and outer rubber, corrugated pipe, metal hose, metal braided pipe, yellow wax pipe, nylon harness, closed terminal, buckle, spacer column, etc



万恩环保

#### 东莞市万恩环保科技有限公司 Dongguan Wonen Environmental Protection Technology Co.,LTD

E3-3B44

地址: 广东省东莞市万江区油新路 38 号

Add: No.38 YouXin Road, Wanjiang Community, Wanjiang District, Dongguan City, Guangdong Province

电话 /Tel: 13412329900

网址 /Web: [www.wonen-ept.com](http://www.wonen-ept.com)

东莞市万恩环保科技有限公司, 成立于 2011 年, 厂房面积 16000 平方米, 员工约 150 人。公司通过 ISO9001-2015 质量管理体系认证。

主营产品: HEPA 过滤器、活性炭过滤器、除甲醛 (VOC) 过滤器、除臭氧过滤器、除病毒过滤器、除菌防霉过滤器、光触媒过滤器、加湿过滤器等各类物理化学空气过滤器。应用于家用空气净化器、扫地机、吸尘器、投影仪、打印机、空调、空气消毒机、风柜、洁净厂房等。

#### 主要展品 /Products

主营产品: HEPA 过滤器、活性炭过滤器、除甲醛 (VOC) 过滤器、除臭氧过滤器、除病毒过滤器、除菌防霉过滤器、光触媒过滤器、加湿过滤器等各类物理化学空气过滤器。应用于家用空气净化器、扫地机、吸尘器、投影仪、打印机、空调、空气消毒机、风柜、洁净厂房等。

#### SUNUN 先领

#### 东莞市先领电源有限公司 Dongguan Sunun Power Co., Ltd

E1-1A26

地址: 东莞市虎门镇大宁社区大板地工业区民安路 16 号 (523220)

Add: No. 16, Min An Road, DaBanDi Industrial Park, DaNing community, HuMen Town, DongGuan

电话 /Tel: 0769-82292616

传真 /Fax: 0769-87002330

网址 /Web: [www.sununpower.com](http://www.sununpower.com)

东莞先领电源有限公司坐落于东莞市虎门镇, 工厂面积 15000 平方米, 拥有员工 500 多人, 月最大产能达 300 万只电源产品。公司专注于电源适配器、充电器等电源产品的研发、制造, 已通过 ISO9001 国际质量体系认证和 ISO14001 国际环境管理体系认证, OHSAS18001, 公司系列产品已通过 UL、GS、CE、PSE、BIS、S-mark、FCC CQC CB 3C 等全球主要安规认证。

DongGuan Sunun Power Co., Ltd. (FROM ShenZhen Sunun Power Technology Co., Ltd. ) was Established in 2008, dedicated to Research and Development of all types of low voltage power converters, manufacturing and sales.

Sunun's conversion products cover power adapters, power supplies and battery chargers. Safety approved standard items include everything from 1 watt to 120 watts output power. Sunun focuses on providing global users with top quality power conversion products. Backed by quite professional R&D team, our daily production capacity can be more than 50,000 units. Our power supplies are the ideal choice for telecommunication, audio video, computer peripheral, consumer electronics, health-care, car facility, commercial equipment and many other consumer electronic devices.

Most of our products passed CE, FCC, UL, CUL, TUV, GS, C-TICK, SAA, CCC, CB, MEPS, EUP, BS, PSE, EK, EMC, EMI and RoHS certificates.

#### 主要展品 /Products

电源适配器及充电器。

Adapters and battery chargers

## 赤灵鹿

东莞市小鹿电器科技有限公司

E3-3B27

**Dongguan Xiaolu Electrical Technology Co., Ltd Introduce**

地址: 广东 东莞市 企石镇新南第一工业一路 7 号 201

电话 /Tel: 076982303756

公司专注于美发、美容、生活小家电的设计、研发、生产, 专业为客户提供 OEM/ODM 服务, 目前公司拥有员工 80 多人, 研发人员 6 人, 4 条标准化生产流水线, 日产能可达 10000 台以上, 主要服务对象包括跨境电商、国内外品牌商、外贸公司等, 我们的宗旨是为客户创造价值, 成就客户、成就自己。先后获得 10 多项国内外专利, 多款产品获得 CCC、CE、FCC、SASO 等产品认证, 企业通过 ISO9001 质量管理体系认证。

Dongguan Xiaolu Electrical Technology Co., Ltd. focuses on the design, research and development, production of hairdressing, beauty, small household appliances, professional to provide customers with OEM/ODM services, the company has more than 80 employees, research and development staff of 6 people, 4 standardized production lines, the daily output of more than 10000 sets. Our main service objects include cross-border e-commerce, domestic and foreign brands, foreign trade companies, etc. Our purpose is to create value for customers, achieve customers, achieve themselves. It has obtained more than 10 patents at home and abroad, many products have obtained CCC, CE, FCC, GCC and other product certification, and the enterprise has passed ISO9001 quality management system certification. and BSCI.

#### 主要展品 /Products

负离子直发 / 直胡梳、无线负离子直发梳、红外线负离子直发梳、迷你直发梳、蒸汽直发梳、激光震动负离子磁性按摩气囊梳、蒸汽卷直一体直发器、无线卷直一体直发器、自动卷发器、负离子热风梳。

**Toyon**

东莞市旭恒电子有限公司

W1-1C71

**Dongguan Xuheng Electronics Co., Ltd**

地址: 广东省东莞市东城桑园工业区二区二路 5 号 (523119)

Add: No.5, 2nd Road, 2nd District, sangyuan Industrial Zone, Dongcheng, Dongguan City, Guangdong Province

电话 /Tel: 86-769-23068090

传真 /Fax: 86-796-23068086

网址 /Web: www.dgxuheng.net

东莞市旭恒电子有限公司成立于 2001 年, 是一家专业从事 DC/EC 散热风扇, DC 无刷马达的研发、制造、销售、服务于一体的企业。公司坚持创新立业, 紧贴市场创立 "X" 与 "TOYON" 以及通风产品 "依摩达、emada" 品牌, 于 2002 年通过并全面导入 ISO9001 国际质量体系认证。

Dongguan Xuheng Electronics Co., Ltd. was founded in 2001, is a professional engaged in DC / EC cooling fan, DC brushless motor research and development, manufacturing, sales, service in one enterprise. The company adheres to innovation, adheres to the market, creates "X" and "toyon"、"emada" brands, and has passed and fully introduced ISO9001 international quality system certification in 2002.

#### 主要展品 /Products

直流管道通风机、DC/EC 散热风扇、直流无刷电机、无刷马达。

DC / EC cooling fan. DC brushless motor. Brushless motor

**YUMYTH**

东莞市亚美世电子科技有限公司

E2-2A12

**Yumyth Electronic Tech Co., Ltd**

地址: 东莞市万江区莫屋大街 29 号 (52300)

Add: No.29 Mowu, Wanjiang District, Dongguan 523041, China

电话 /Tel: 18038291949

网址 /Web: www.yumyth.com

亚美世位于东莞万江, 专业生产家用真空封口机、烟熏机、厨余垃圾处理器、真空罐等小家电。团队具有丰富的研发设计、生产、质量控制的能力, 拥有生产所需的全套质量检测设备。产品拥有 CE、GS、CB、ETL 证书, 满足不同地区出口, 拥有外观和实用新型专利高达 40 多项。通过 ISO 9001:2015 和 BSCI 体系认证, 2019 年被评为高新科技技术企业。在未来我们将不断地自我完善, 做性能更优的产品, 让生活更美好。

Yumyth is located in Wanjiang Dongguan, specializing in household vacuum sealer, smoker infuser, food waste disposer and vacuum canister etc. We own mature R&D, manufacture and quality control ability, with completed quality inspection facility. All product has approved CE, GS, CB and ETL certificated to meet more market export. Yumyth has obtained over 40 appearance and utility patent. We also meet ISO9001:2015 and BSCI management system and was awarded as 'High Tech Enterprise' in 2019. We will keep developing more improved products and make a better life.

**主要展品 /Products**

工厂主要生产家用真空封口机、烟熏机、厨余垃圾处理器、真空保鲜罐,料理机等小家电产品  
We mainly produce household vacuum sealing machines, smoking machines, kitchen waste processors, vacuum fresh-keeping cans, cooking machines and other small household appliances

**东莞市耀和玻璃有限公司**  
**Dongguan Yaohe Glass Co., Ltd**
**W1-1B20**

地址: 广东省东莞市石排镇赤坎水厂路 11 号  
电话 /Tel: 18128557217  
网址 /Web: www.yaoheglass.com

东莞市耀和玻璃有限公司成立于 2017 年, 坐落于广东省东莞市, 公司占地面积 7000 平方米, 是一家从事钢化玻璃, 镜子等产品的研发、生产、销售和服务为一体的专业 OEM 制造企业。耀和玻璃深耕于行业发展, 坚持为客户提供高品质的产品。主要产品涵盖有色钢化玻璃、家用电器玻璃、电子玻璃、时钟玻璃、镀膜玻璃、钢化镜、高温低温丝印玻璃等深加工产品, 所生产的玻璃品种齐全, 产品涵盖装饰、家电、安防、电子、数码等行业领域。

**主要展品 /Products**

家用电器玻璃, 电子 / 安防玻璃, AG 玻璃 /AR 玻璃色玻, 彩色丝印玻璃, 卫浴 / 灯具 / 时钟玻璃, 镜子 / 钢化镜。

**东莞市钰鑫电子科技有限公司**
**W4-4B30 4B31**

地址: 东莞市虎门镇宁江路 19 号 (523861)  
电话 /Tel: 0769-85101109  
传真 /Fax: 85101129  
网址 /Web: www.exintech.cn

东莞市钰鑫电子科技有限公司是一家集研发、生产和销售为一体的国家高新技术企业, 拥有 8000 平方米的制造基地, 业务覆盖欧美、中东、东南亚等地区。现有员工 200 余名, 技术领军者在行业内超过 20 年的工作经验。主营产品: TDS 传感器、接近开关、水位开关、光电式液位传感器、电容式液位传感器、流量计、UVC 杀菌器等, 产品广泛应用空调、小家电、净饮水、环保、空净、等行业。

**主要展品 /Products**

TDS 传感器、接近开关、水位开关、光电式液位传感器、电容式液位传感器、流量计、UVC 杀菌器等

**东莞市银泰丰光学科技有限公司**  
**Yin Tai Feng (Dong Guan City) Optical Technology Co., Ltd.**
**W5-5D71**

地址: 广东省东莞市沙田镇临海北路 65 号 (523000)  
Add: No.65, Lin Hai Bei Road, Sui Feng Nian Village of Sha Tian Town, Dong Guan, Guang Dong Province, China  
电话 /Tel: 13642951619  
传真 /Fax: 0769-38969289  
网址 /Web: www.ytfglass.com

东莞市银泰丰光学科技有限公司位于东莞市沙田镇, 由具有 33 年玻璃深加工经验的东莞市银通玻璃有限公司投资创建, 以家电玻璃和电子玻璃为主的高新技术企业。工厂占地面积 8.5 万 m<sup>2</sup>, 可加工 0.7-6mm 不同厚度和规格的玻璃, 拥有玻璃全制程加工能力, 独立完成切割、CNC、钻孔、丝印、物理 / 钢化、AR/AG/AF、彩色镀膜、各种功能膜和光学膜贴合等玻璃深加工工艺, 为不同的客户, 不同的应用, 提供适当的解决方案。

Yin tai feng (Dong Guan City) optical Technology Co., Ltd is located in Shatian Town, Dongguan City, which has convenient transportation. It is a large high-tech enterprise focusing on household appliance glass and electronic glass, invested by Dongguan Yintong Glass Co., Ltd. with 33 years of experience in glass deep processing filed. Covers an area of 85,000 square meters, Yintafeng is able to offer glasses of various thicknesses ranging from 0.7-6.0mm and of different specifications and shapes. Its integrated glass processing ability is able to independently finish deep processing such as machine cutting, water jet cutting, laser cutting, CNC edge grinding, drilling, screen printing, physical tempering, chemical tempering, AR/AG/AF, colored film coating, multi-functional film pasting. We have established good cooperation with many famous companies at home and abroad to provide appropriate solutions for different customers and different applications.

**主要展品 /Products**

电子玻璃: 商显盖板、触摸屏、TV、背板等;  
光学玻璃: 扩散板、导光板等;  
家电玻璃: 冰箱、洗衣机、洗碗机、智能衣柜、钢化镜、健身镜, 音响玻璃等;  
厨电玻璃: 烤箱、微波炉、灶具、抽油烟机等等;

Electronic Glass: Cover Glass application on Education/Meeting Panel, Touch panel, TV, Back Cover Glass, etc;  
Optical glass: Diffuser Plate Glass, LGP, etc;  
Appliance glass: Refrigerator glass, Washing machine glass, Dishwasher glass, Smart Wardrobe glass, Toughened mirror, smart fitness mirror, Sound equipment glass, etc;  
Kitchen electric glass: Oven, Microwave oven, cookware, lampblack machine, etc

## 优尼雅 YULIA

东莞市优尼雅电子科技有限公司  
Dongguan Yulia Electronic Technology Co., Ltd.

E2-2D86

地址: 广东省东莞市清溪镇三中村金龙工业区环拓厂区 2 栋 (523651)  
Add: Building 2, Huantuo Factory Zone, Jinlong Industrial Zone, Sanzhong Village, Qingxi Town,  
Dongguan City, Guangdong Province, China  
电话 /Tel: 0769-87897588  
传真 /Fax: 0769-87897588  
网址 /Web: <http://www.szyulia.com/>

东莞市优尼雅电子科技有限公司是一家集研发, 生产, 销售, 售后服务于一体的专业净水器制造商。

Yulia 成立于 2002 年, 我们在处理各种 OEM / ODM 订单方面经验非常丰富。工厂占地面积 30000 平方米。工厂有 41 台注塑机, 9 套装配线, 2 套自动喷漆流水线, 2 间产品研发室。月产量 30000 套。20 年专业制造经验和强大的加工能力。我们为来自欧洲, 亚洲, 中东和南美的全球客户提供服务。

Dongguan Yulia Electronic Technology Co., Ltd is a professional water purifier manufacturer integrating R&D, producing, sales and after-sales service.

Yulia was founded in 2002, We are very experienced in dealing with all kinds of OEM/ODM orders. Our factory is 25000 square meters. There are 41 injection machine, 19 assembling line, 2 automatic painting line, 5 bristle planting machine and so on. Monthly output 30000 sets. With 16 years manufacturing experience and strong processing capability. We serve customers from all over the world, including Europe, American, Asia, Middle east and South American.

We have a team of experts vet each piece of material, ensuring it meets those standards by researching ingredients, auditing sourcing practices, and testing products. Almost all of Yulia's products have passed certifications and tests, such as NSF, WQA, ISO13485, ISO9001, CE, RoHS, UL certification, and FCC test. The belief of sustainability throughout all operations is part of Yulia's DNA

### 主要展品 /Products

净饮机 直饮机 饮水机 净水器 纯水机 软水机 免安装净水器 瞬热净水器 电动牙刷  
water purifier water filter water dispenser ro water dispenser desktop water dispenser ro water purifier uv water purifier desktop water purifier Hydrogen-rich water purifier electric toothbrush

## ZESTBO

东莞市泽宝智能科技有限公司  
Dongguan Zestbo Intelligent Technology Co. Ltd.

N3-3B40

地址: 东莞市东坑镇新寮路 1 号中慧通讯产业园 b 栋六楼  
Add: NO.601#Building-2, Xinliao Road, Dongkeng Town, Dongguan City, Guangdong  
Province, China  
电话 /Tel: 75582124856

东莞市泽宝智能科技是一家专业生产胶囊咖啡机和奶泡机的厂家, 自 2014 年成立以来, 通过了 BSCI 和 ISO9001 认证。工厂位于广东省东莞市, 建筑面积 7000 平方米, 生产面积 1500 平方米, 成

品及原材料仓库 1500 平方米。工厂有注塑机 10 台, 丝印和移印机, 水泵测试仪, 流量计测试仪, 模具车间, 老化室等设备和车间。3 条装配线日生产量可达 4500 台。我们诚挚期待与您建立互利共赢的合作关系。

Zestbo is a specialized BSCI and ISO9001 certified manufacturer of capsule coffee machine for kcup, nespresso and dolce gusto capsules since 2014, most products have got ETL, CETL, CE, ROHS, CB etc. Certificate, hope to cooperate with you.

### 主要展品 /Products

胶囊咖啡机 (k-cup 胶囊咖啡机, nespresso 胶囊咖啡机, Dolce gusto 胶囊咖啡机) 和奶泡机  
capsule coffee machine for kcup, nespresso and dolce gusto capsules and milk frother



东莞市智创源科技有限公司  
Dongguan Zhichuangyuan Technology Co., Ltd

E3-3A35

地址: 广东省东莞市南城街道东莞大道南城段 428 号寰宇汇金中心 9 栋 1 单元 5506 室  
电话 /Tel: 0769-3883885

智创源—高速吹风机专业制造商源头工厂, 自主开发生产制造

### 主要展品 /Products

高速吹风机



东莞圆锋电子有限公司

E1-1A40

地址: 广东省东莞市常平镇桥沥村常黄路 166 号圆锋电子 (523586)  
电话 /Tel: 769-8600-1933  
传真 /Fax: 769-8600-1923  
网址 /Web: <https://www.reedswitchcn.com/>

东莞圆锋电子有限公司, 1982 年创始于中国台湾, 2002 年于东莞设立工厂, 深耕传感器领域二十余年, 通过 ISO9001 及 IATF16949 质量管理体系认证。

致力于为客户提供专业靠谱的开发技术援助, 设计生产符合客户实际使用需求的各类磁感应开关, 并以不断提高品质为目标。

产品主要用于厨卫家电, 防盗系统, 汽车自动控制, 3C 产业, 测试、医疗仪器等行业。除国内市场外, 还销往东南亚、欧洲、美洲、印尼等地区。

### 主要展品 /Products

接近开关; 浮球开关; 液位开关; 磁控开关; 高压继电器; 浮球; 水流开关



**智城创联****东莞智城创联科技有限公司****Dongguan Zhichengchuanglian Technology Co., Ltd**

地址: 广东省东莞市大岭山镇大岭山拥军路 136 号 5 栋 6 楼

电话 /Tel: 18565799670

东莞智城创联科技有限公司成立于 2018 年, 总投资 500 万元人民币。公司现有员工 150 多名, 年营销售额超过 8000 万元人民币。我们专注于电动清洁工具产品类目, 开发了十余款针对家用场景的电动清洁工具, 涵盖地板墙面, 厕所浴室, 厨房厨具, 便携吸尘等。公司建立了近 20 人规模的研发团队, 拥有专业级的实验室及测试设备。取得 80 余项发明和实用新型专利。每款产品都通过了 CE, FCC, ROHS, KC, UL, 等国际认证。

**主要展品 /Products**

电动清洁刷, 电动马桶刷, 吸尘器, 扫地机器人

**N2-2A52****东莞智信五金制品有限公司****DONGGUAN ZHIXIN METALLIC PRODUCTS CO., LTD.**

地址: 广东省东莞市塘厦镇龙背岭得胜路 6 号

电话 /Tel: 0769-86855399

东莞智信五金制品有限公司成立于 2002 年 10 月, 于 2003 年 3 月正式投产运营, 公司坐落于交通物流发达的东莞市塘厦镇, 在青岛、苏州、重庆、惠州、广州等地设立办事处, 构筑了辐射式的市场网络运营体系和售后服务支持。历经二十载的成长与积淀, 现已发展为一家集铝合金外观结构件与铝合金功能散热器研发、生产、销售于一体的公司, 为客户提供专业铝合金外观结构件与散热管理相关完整的解决方案专业生产制造商。

**主要展品 /Products**

家用电视边框, 商显边框, 黑白电类面板, 边框, 把手等, 安防门铃类, 音频产品类等相关铝合金外观结构件与散热器管理相关完整的解决方案。

**W4-4A15****DONGNAN****东南电子股份有限公司****DONGNAN ELECTRONICS CO.,LTD**

地址: 浙江省乐清经济开发区纬十一路 218 号 (325600)

Add: No.218 Weishiyi Rd, Yueqing Economic Development Zone, ZheJiang Province, China

电话 /Tel: 15958778877

传真 /Fax: 0577-62539762

网址 /Web: www.switch-china.com

东南电子始创建于 1987 年, 国家级高新技术企业, 注册资金 6438 万元, 现有厂房面积 9 万多平方米, 总资产 5.1 亿元。

**W2-2A30 2A31**

我们有超过 30 年制造开关的经验, 主要生产微动开关、防水微动开关、按钮式电源开关、门控开关、旋转开关、电压选择开关等, 集产品研发、生产、销售、售后服务为一体的开关专业制造企业, 产品覆盖全国各地及全球 20 余个国家和地区, 所有产品均通过权威安规认证并拥有多项国家专利。

DONGNAN ELECTRONICS CO.,LTD established in 1987,a national high-tech enterprise with a registered capital of 64.38 million yuan, a factory area of more than 90,000 square meters and a total asset of 510 million yuan. with more than 30 years manufacturing experience in making switches.Mainly produce micro switches, water proof micro switches, power switches, gate control switches, rotary switches, voltage-selected switches etc.We are a switch professional manufacturing enterprise that has R&D, producing, marketing and after-sales service. Our switches cover all over the country and more than 20 countries and regions in the world.. Allproducts have passed the authoritative safety certification and hold a number of national patents.

**主要展品 /Products**微动开关、防水微动开关、按钮式电源开关、门控开关、旋转开关、电压选择开关等  
Micro switch, waterproof micro switch, push-button power switch, gating switch, rotary switch, voltage selection switch, etc**東洋桑工業科技(上海)有限公司****Toyosan Industrial Technology (Shanghai) Co., Ltd**

地址: 上海市松江区中山街道明南路 8 5 号 17 棟

电话 /Tel: 021-57715918

東洋桑工業科技(上海)有限公司

東洋桑專注空氣除濕、加濕、制冷、全新風技術產品的推廣和應用。產品廣泛應用於民用、商用, 涉及醫藥、食品、住宅、醫院、冷庫等眾多領域。為客戶提供多層次的应用方案。

**主要展品 /Products**

全新風恒溫恒濕機、高分子全氣候空調、地下室專用全氣候空調;

**W2-2D76**

美好生活 触手可得

**抖音电商**

地址: 上海市楊浦區江灣城路 99 号 0 幢名義層 6 层 604 室

电话 /Tel: 400-612-6007

抖音电商开创兴趣电商新风貌, 以内容为中心的“兴趣电商”新模式为整个电商行业带来新的想象空间。抖音电商聚焦平台 5 大优势——规模化用户体量、繁荣的内容生态、领先的营销能力、全面的购物场景、一站式全链经营, 以兴趣引领生意经营, 以内容重塑消费链路, 激活全新生意场, 持续为生态伙伴的发展提供助力, 共同推动整个电商行业的发展。

**主要展品 /Products**

抖音是一个帮助用户表达自我、记录美好生活的平台。抖音让每一个人看见并连接更大的世界, 鼓励表达、沟通和记录, 激发创造, 丰富人们的精神世界, 让现实生活更美好。截止 2020 年 8 月, 包括抖音火山版在内, 抖音日活跃用户超过 6 亿, 并继续保持高速增长。

**E2-2F61**

**杜邦中国集团有限公司****DuPont China Holding Co., Ltd.****E2-2C71**

地址: 上海市浦东新区东育路 255 弄 4 号前滩世贸中心一期 A 座 28 楼 (201203)

Add: No. 600, Cailun Road, Zhangjiang Hi-Tech Park, Pudong New District,

Shanghai 201203, PRC

电话 /Tel: 400-661-2629

传真 /Fax: 021- 20589000

网址 /Web: www.dupont.cn

杜邦在家用净水领域拥有 40 多年丰富经验, 在性能和可靠性方面缔造了辉煌的历史, 为世界各地千家万户提供新鲜、安全、洁净的饮用水及全方位的全屋净水解决方案。

杜邦™TapTec™泰湃科™确保家庭供水最为洁净, 帮助人们实现高品质的生活体验, 其超滤(UF)、反渗透(RO)、离子交换树脂(IEE)和纳滤(NF)技术及产品已广泛应用于台式直饮机、滤水壶、中央软水机、净水器等全屋净水系统中。

With more than 40 years of experience in water treatment and a proven track record of performance and reliability, DuPont Water Solutions, bringing fresh, safe, clean drinking water to millions of homes, offering a range of residential water treatment options incl. UF, RO, IER & NF products which have been widely used in tabletop water purifier, water pitcher, central water softener and other whole-house water purification systems, to ensure a home's water supply is the cleanest it can be and helps people pursue quality of life.

**主要展品 /Products**

杜邦™FilmTec™ Aqualast™ 1812-HR

杜邦™FilmTec™ TW30-1812-50HR

杜邦™泰湃科™ TT-3013-1000 家用反渗透膜

杜邦™泰湃科™ TT-3013-600 家用反渗透膜

杜邦™泰湃科™ TT-1812-75XT 家用反渗透膜

杜邦™泰湃科™ TT-3012-400XT 家用反渗透膜

DuPont™FilmTec™ Aqualast™ 1812-HR

DuPont™FilmTec™ TW30-1812-50HR

DuPont™ TapTec™ TT-3013-1000 Residential RO Element

DuPont™ TapTec™ TT-3013-600 Residential RO Element

DuPont™ TapTec™ TT-1812-75XT Residential RO Element

DuPont™ TapTec™ TT-3012-400XT Residential RO Element

FONU

**法诺设计  
FONU****W5-5A15**

地址: 浙江省宁波市鄞州区邱隘镇嘉善路 216 弄 6 号 13-1 室 (315100)

电话 /Tel: 13736062450

传真 /Fax: 13736062450

网址 /Web: www.nbfonu.com

法诺设计(宁波市法诺工业设计有限公司)正式成立于 2011 年, 于 2017 年成立广东分公司。始终坚持服务于制造业, 成为开放式创新研发中的重要一环。"Less but better" 是我们倡导的设计法则, 在设计中不断探索着人与产品之间的协调关系。

法诺设计(宁波市法诺工业设计有限公司)正式成立于 2011 年, 于 2017 年成立广东分公司。始终坚持服务于制造业, 成为开放式创新研发中的重要一环。"Less but better" 是我们倡导的设计法则, 在设计中不断探索着人与产品之间的协调关系。

**主要展品 /Products**

产品设计、结构设计、外观设计、

**凤凰光学股份有限公司  
Phenix Optics Co., Ltd.****W4-4E81**

地址: 江西省上饶市凤凰西大道 197 号 (334000)

电话 /Tel: 057185009981

凤凰光学前身江西光学仪器总厂, 于 1965 年在江西上饶成立; 1996 年正式更名为凤凰光学, 是一家超过半个世纪历史的世界知名光学企业。1997 年, 凤凰光学登陆上海证交所 (上证代码: 600071), 成为中国光学行业第一家上市公司。公司注册资金 2.8 亿元, 总部位于江西省上饶市, 占地面积约 500 亩, 目前员工人数 3300 余人。

Formerly named Jiangxi Optical Instrument Plant established in 1965. Shangrao, Jiangxi province), Phenix Optics is a world famous optical enterprise with over half a century of history. The registered capital of the company reaches 280 million RMB and it is headquartered in Shangrao, Jiangxi province. With over 330,000m of manufacturing area and 3300 employees as of year 2021, Phenix is able to deliver quality products efficiently and effectively for our customers. Phenix was also the first optical company listed on the Shanghai Stock Exchange in 1997 (Code: 600071)

**主要展品 /Products**

部品加工, 光学镜头, 摄像模组, 智能控制, 科学仪器, 电池六大业务板块的有机整合, 为客户提供全方位的产品和服务。

Parts & components, Imaging lenses, Camera module, Intelligent control, Scientific instrument, Battery 6 highly integrated business sectors combined to provide customers with full range of products and services.

**Smart Frog 卡蛙****佛山卡蛙科技股份有限公司****E2-2C51-01**

地址：广东省佛山市顺德区大良镇大良新能源汽车小镇 1 期 A1 独栋卡蛙科技有限公司

电话 /Tel: 075722398907

网址 /Web: www.smartfrog.com.cn

卡蛙科技股份有限公司成立于 2013 年，主要经营风扇、加热器、加湿器、干衣机等小型家用原创产品，为消费者提供高价值、高性价比、优质体验的产品。Smart frog 产品还多次获得 IF、韩国 Good design、省长杯、D-DAY 等设计奖，并获得 50 多项发明、实用新型等专利。卡蛙将贯彻“美好造物”的思想，每年研发 10 款以上新品，为消费者提供源源不断的优质产品体验。

**主要展品 /Products**

电风扇、循环扇、取暖器、暖脚器、加湿器、干衣机、除湿机、香薰机、挂烫机

**开彩科技****佛山开彩科技有限公司****W1-1C61**

地址：广东省佛山市顺德区大良棠业三路

电话 /Tel: 17038246999

佛山开彩科技有限公司专业从事智能电热供暖设备的研发与制造，是一家集生产、销售、安装、服务于一体的中外合资高新技术企业。旗下有多家分公司及多个运营板块。主营国内煤改电工程的推广运营。

公司现已通过 ISO 9001 质量、IS 014001 环境、ISO 18000 健康等多项管理体系认证，所有产品均通过中国 CCC 强制认证，服务 5 星认证、节能认证，及多种高标准检测认证。并获得 20 余项自主知识产权，专利。

**主要展品 /Products**

电加热器、暖风机、辐射器、风扇

**佛山凯缔文化创意有限公司****E2-2C51-12**

地址：佛山市顺德区北滘镇设计城居委会三乐路北 1 号设计城二期西座 1 楼 102 室

电话 /Tel: 0757-2663-0295

网址 /Web: http://www.kidpchina.cn/

2019 年 6 月在佛山顺德正式成立，为促进韩国优秀设计企业与华南地区设计产业的紧密合作，由韩国设计振兴院与顺德区

区人民政府共同创办。我们有 10 家韩国优秀设计企业提供专业设计服务，包括产品设计、包装设计、视觉设计、平面设计、环境设计等领域。

- 专业设计咨询及开发
- 定期举办商务洽谈会
- 定期举办讲座、培训等公益活动

- 参加各种工业设计博览

**主要展品 /Products**

工业产品设计、工艺设计、服装设计、包装设计、金属制品设计、纺织品设计、陶瓷制品设计、玻璃制品设计、皮革制品设计、塑料制品设计、文具设计、箱包设计、日用百货设计、电子产品设计及上述设计的服务与咨询；从事工艺品、服装、包装材料、金属制品、纺织品、陶瓷制品、玻璃制品、皮革制品、塑料制品（不含废旧塑料）、文具、箱包、日用百货、电子产品的批发零售及进出口业务。

**佛山卢国辉电器实业有限公司****W2-2A46****Foshan Luguohui Electric Industrial Co.,Ltd**

地址：广东省佛山市顺德区勒流镇勒良路众涌工业区 (528322)

Add: Zhongchong industrial area,leiliang road,leiliu Town,Shunde

电话 /Tel: 0757-23666926

传真 /Fax: 0757-25531323

网址 /Web: www.luguohui.com

佛山卢国辉电器实业有限公司，始创于 1991 年，位于广东省佛山市顺德区，属于广东省扶持计划的星光企业。

公司自主研发、专业生产、销售母婴电动护理类（电吹风、吸发理发器等）及餐具（辅食碗、调温碗套装等）类用品，家用加湿器、香薰机、快销品的创意小风扇等家电及相关产业配套。专注于全球家电用品及生活用品市场，主要经营塑料配件比例占成本 60% 以上的系列产品，拥有 20 年的专业生产经验。

**主要展品 /Products**

儿童电吹风，儿童餐具，手持风扇，加湿器，香薰机

Hair Dryer for Children, Handheld Fan, Humidifier, Aroma diffuser

**佛山美立三维科技有限公司****W1-1A50****Trio Industrial Solutions**

地址：广东省佛山市顺德区北滘镇马龙西南工业区龙汇路 2 号 3 栋 3-5 楼

Add: Floor 3-5, Building 3, No.2 Longhui Road, MalongSouthwest Industrial Zone, Beijiao Town, Shunde District, Foshan City,Guangdong Province. PRC.

电话 /Tel: 0757-26338488

网址 /Web: www.triois.com.cn

美立三维成立于 2016 年，拥有结构设计、模型制造、小批量制造、大批量零部件制造、产品后处理的一站式服务，致力于为客户提供最优质高效的产品设计和生产制造服务。公司服务领域涉及国内外家电，汽车，医疗，新能源，机器人，航空航天，影视文化，体育竞技等行业。帮助客户降低产品开发制造成本，缩短产品交付周期，有效提高产品市场竞争力。

**主要展品 /Products**

美立三维可提供结构设计，3D 打印，CNC，复模，钣金，精密开模，批量注塑等一站式服务



**佛山市安净电器有限公司**  
**Foshan anjing electrics co., ltd**

**N1-1A42**

地址: 佛山市高明区荷城街道知行街 20 号 1806 室  
Add: Room 1806, No.20 Zhixing Street, Lotus town Street, Gaoming District, Foshan City  
电话 /Tel: 0757-89932188

企业成立于 2006 年 12 月, 注册资金 132 万美元, 有着二十年的电热水壶行业研发、设计与制造经验, 是一家集电热水壶、养生壶、电火锅研发、制造与销售为一体的家电企业。公司秉承着“高质量、创新、环保”的产品理念, 致力于为广大客户提供高品质电热水壶 OEM、ODM 定制、批发等方案。

Founded in December 2006, with a registered capital of 1.32 million US dollars, the enterprise has 20 years of experience in R&D, design and manufacturing of electric kettle industry, and is a small household appliance enterprise integrating R&D, manufacturing and sales of electric kettle, health pot and electric hot pot. Adhering to the product concept of "high quality, innovation and environmental protection", the company is committed to providing our customers with high-quality electric kettle OEM, ODM customization, wholesale and other programs

**主要展品 /Products**

八克拉加热过滤水壶  
Electric water filter kettle



**佛山市奥力给电器有限公司**  
**Foshan oliga Electric Co.,Ltd**

**E2-2B01**

地址: 广东省佛山市顺德区容桂新幸福广场商业中心 1919 (52800)  
Add: 1919,Block 9,New Xingfu Linghui,plaza,No.1,West Guizhou Avenue,Ronggui ,Shunde District,Foshan,City,Guangdong Povince,China  
电话 /Tel: 0757-28370705  
网址 /Web: www.oliga-china.com

佛山市奥力给电器有限公司, 位于家电之乡 - 广东顺德, 公司是集研发、生产、销售于一体的企业。现有专业研发技术人员近 20 人, 以发展智能制作为核心的核心理念, 共创辉煌。公司主营包括奶泡机, 电动真空罐、磨豆机、电水壶, 手冲咖啡壶等, 我们以创新为生存之本并以此为荣, 欢迎任何的 OEM 和 ODM 的合作。

Foshan Oliga Electric Appliance Co., LTD., located in Shunde, the home appliance manufacturing town of China. The company is a research and development, production, sales in one of the enterprises. There are nearly 20 professional R & D and technical personnel  
Our main business includes vacuum packaging preservation machine, coffee machine, milk foam machine, electric kettle, grinding bean machine, with diversified product lines to create competitive edge, with intelligent research and development, quality service, so that enterprises reduce production and storage costs.

With the management philosophy of scientific and technological innovation as the foundation of survival and product quality as the cornerstone of survival, we have obtained ISO,GS, CE, BSCI, ROSH,REACH, UL and other certificates. At present, the company has nearly one hundred utility

model and appearance patents, Welcome all customers from all over the world

**主要展品 /Products**

奶泡机, 真空罐, 电水壶, 磨豆机, 鹅颈电热水壶, 电水壶, 烘豆机等  
Milk frother, vacuum Jar, electric kettle, bean grinder, Gooseneck electric kettle, electric kettle, bean baking machine, etc



**佛山市百斯特电器科技有限公司**  
**Foshan Best Electric Appliance and Technology Co., Ltd.**

**N2-2A33 2A34**

地址: 广东省佛山市顺德区乐从镇上华智能制造产业园 D6 座  
Add: Block D6, Sonva Intelligent Manufacturing Technology Park, Lecong, Shunde, Foshan, Guangdong, P.R. China  
电话 /Tel: 0757-22207076  
传真 /Fax: 0757-22207076  
网址 /Web: www.dwash.com

佛山市百斯特电器科技有限公司是一家专业研发, 制造洗碗机及其核心零部件的创新型企业, 位于有家电王国之称的佛山市顺德区, 也是中国最具经济实力和活力发展潜力的珠三角腹地。公司成立于 2015 年, 拥有一支经验丰富、熟悉产品标准的专业研发团队, 能够对产品和性能进行自主研发。目前, 该产品已获得 32 项发明专利、200 项实用新型和 76 项外观专利。

Foshan Best Electric Technology Co., Ltd. is an innovative enterprise specializing in R&D and manufacturing dishwasher and its core components. It is located in Shunde District, Foshan City, which is known as the home appliance kingdom, and is also the hinterland of the Pearl River Delta with the most economic strength and development vitality in China. Founded in 2015, the company has a professional R&D team with rich experience and familiarity with product standards, which can conduct independent research and development of products and performance. At present, the products have been granted 32 invention patents, 200 utility models and 76 appearance patents.

**主要展品 /Products**

家用洗碗机  
Household dishwasher



**川东磁电**  
**佛山市川东磁电股份有限公司**  
**Chuangdong Magnetic Electronics Co., Ltd.**

**W2-2B10 2B11**

地址: 广东省佛山市高明区沧江工业园杨和镇和顺路 372 号 (528500)  
Add: No. 372, Heshun Road, Cangjiang Industrial Area, Yanghe Town, Gaoming district, Foshan, Guangdong.  
电话 /Tel: 0757-86145032  
传真 /Fax: 0757-88802199



网址 /Web: www.cdm21.com

佛山市川东磁电股份有限公司是专业从事敏感元件与传感器、控制器研发、生产和销售一体的国家高新技术企业。公司自成立以来，致力于成为家电、汽车、医疗健康、环保节能和装备制造业领域的应用技术及方案提供商，着力于打造成基于敏感材料制备技术的磁敏、热敏、湿敏、力敏和光敏等全方位的传感和控制技术综合集成平台。

As a national hi-tech enterprise specializing in R&D, production and sales of sensitive elements, sensors and controllers, Chuandong Magnetic Electronics Co., Ltd. has devoted to becoming a supplier of applied technologies and solutions in the fields of home appliance, automobiles, health care, green energy and equipment manufacturing since the establishment, and focused creating an overall comprehensive integral platform of sensing and controlling technologies of magnetic sensing, thermal sensing, humidity sensing, force sensing and light sensing on the basis of new preparative techniques of sensitive material.

#### 主要展品 /Products

磁控接近开关、磁敏温度开关、液位开关 & 浮子、靶流开关、非接触液位传感器、温湿度传感器、微波传感器、TMR 液位传感器、光电式液位传感器、流量传感器、浊度传感器、UV 杀菌模块等

Magnetic proximity switch, Magnetic temperature switch, Liquid level switch & float, Magnetic paddle flow switch, Non-contact liquid level sensor, Temperature and humidity sensor, Microwave sensor, TMR level sensor, Photoelectric level sensor, Flow sensor, Turbidity sensor, UV sterilization module, etc.

## GRANS FASSIAN

格兰法西恩

佛山市创隆电器有限公司

Foshan Get Grand Electronic Appliance Co., Ltd

地址：广东省佛山市顺德区均安镇均安社区仓沙西路5号(528300)

Add: Cangsha West Road, Jun'an Town, Shunde District, Foshan City, Guangdong

电话 /Tel: 0757-25330118

传真 /Fax: 0757-25330112

网址 /Web: www.oasiskitchen.com.cn

佛山市创隆电器有限公司，主要产品为红酒柜、冰吧、烟机、烤箱、蒸烤箱、电磁炉、电陶炉、烟灶一体机等家用电器，产品认证齐全，适应内销和出口。我司通过 ISO9001 体系认证，拥有多年的生产经验和过硬的设备实力，能灵活适配客户需求，拥有 CNAS 认证实验室，专业供应 OEM/ODM 贴牌，各类定制家电，品牌产品供货等多种合作模式。

Foshan Get Grand Electronic Appliance Co., Ltd. mainly produces household appliances such as wine cooler, ice bars, cooker hood, ovens, steam ovens, induction cookers, electric ceramic ovens, and smoke and stove integrated machines. The products are fully certified and suitable for domestic and export. Our company has passed the ISO9001 system certification, has many years of production experience and excellent equipment strength, and can flexibly adapt to customer needs. We have a CNAS certified laboratory, specialized in supplying OEM/ODM labeling, various customized household appliances, brand product supply, and many other cooperation modes.

#### 主要展品 /Products

抽油烟机、烤箱、红酒柜、嵌入式电磁炉、嵌入式微晶炉、蒸汽烤箱、加热柜  
cooker hood, built-in oven, wine cooler, induction hob, ceramic hob, steam oven, warming drawer

## ocvin 德嶸

佛山市德嶸电器有限公司

地址：佛山市顺德区均安镇多浦马山路4号

电话 /Tel: 0757-25502117

制造：家用电器、厨房电器，经营和代理各类商品及技术的进出口业务

#### 主要展品 /Products

多功能煮食锅、烧烤炉  
multi cooker easy grill

N1-1B28

## FSUAFD

方块设计

佛山市方块工业设计有限公司

Foshan Square industrial design Co., Ltd

地址：广东省佛山市顺德区北滘镇工业大道22号广东工业设计城国际创新设计中心2栋1楼  
(方块设计)

Add: No. 22, Industrial Avenue, Beibei Town, Shunde District, Foshan City, Guangdong  
Province, China

电话 /Tel: 13622522273

网址 /Web: http://www.sq-id.com/

E2-2C51-05

方块设计是一家具有创新思维的设计服务机构，服务内容包括：工业设计、交互体验设计、品牌设计等。我们致力于通过国际先进的设计流程使创新与设计的质量具有可控性，帮助制造企业研发创新产品。同时希望通过设计挖掘用户的根本需求和渴望，满足用户更深层次的体验需求，并为企业转化为具有市场竞争力的产品。我们在各个设计领域持续获得国内外设计大奖超70项，服务的品牌包括：美的、COLMO、海尔、西屋、惠而浦、TCL等。

Square Industrial Design Co., Ltd. is a design service organization with innovative thinking. We are committed to the control of the quality of innovation and design through internationally advanced design processes.

At the same time, we hope that through the design to discover the user's fundamental needs and aspirations, to meet the deeper experience needs of users, and therefore translate into a market competitiveness of products for the enterprise.

We have a team of excellent designers, with rich experience in international design.

Customers cover many domestic and foreign brands, including Midea, TOSHIBA, Hisense, Westinghouse, Vanward, DUUX, Genki Forest, Whirlpool, TCL etc.

Our team designers at home and abroad have obtained more than 70 awards in the design field, including red dot, IF, IDEA, GMARK and many other internationally renowned awards.

#### 主要展品 /Products

小家电、厨卫电器、供暖制冷等商用设备，以及个人护理、智能硬件等，提供设计服务：包括产品策略、工业设计、交互体验设计、品牌设计、动画视频制作等。

Commercial equipment such as small household appliances, kitchen and bathroom appliances, heating and refrigeration, as well as personal care and intelligent hardware, Provide design services: including product strategy, industrial design, interactive experience design, brand design, animation and video production, etc.

## CIH

## 佛山市佛尔圣电子科技有限公司

E2-2G76

地址: 广东省中山市东升镇中发街 30 号

电话 /Tel: 0760-22828936

集团秉承着创造一个年轻、活力的品牌为目标,让 CIH 成为年轻一代都认可青睐的品牌,以 [ 舒适 ]、[ 智能 ]、[ 健康 ] 为发展导向,致力于成为全球最优秀的家电供应商,将更具创新性、时尚性活力性的产品带给全世界,为全世界的家庭送去健康和舒适!我们的口号是:给我们一个支点,CIH 将走向世界,走进千家万户!

## 主要展品 /Products

塔扇、循环扇、取暖器、加湿器、空气炸锅、破壁机、绞肉机、电饭煲、即热饮水机、电蒸锅、电炒锅、电烤盘等

## GREENYELLOW

## 格林盈璐

## 佛山市格林盈璐电器科技有限公司

E2-2B06

Foshan GreenYellow Electric Technology Co.,Ltd

地址: 广东省佛山市大良五沙顺和南路 2 号欧洲工业园 1 号厂房 3 楼 (528300)

Add: Foshan GreenYellow Electric Tech

电话 /Tel: 0757-22825698

传真 /Fax: 0757-28083200

网址 /Web: www.greenyellow.cn

公司成立于 2009 年,格林盈璐是一家现代创新型家电企业,从事各种生活电器的研发、制造、营销和服务等事业活动。旗下拥有格林盈璐、盈璐、百事顺、百事美等多个品牌,已累计为美国、意大利、日本、马来西亚等 30 多个国家和地区的千万余用户提供完备的居所环境治理解决方案。

公司成立于 2009 年,格林盈璐是一家现代创新型家电企业,从事各种生活电器的研发、制造、营销和服务等事业活动。旗下拥有格林盈璐、盈璐、百事顺、百事美等多个品牌,已累计为美国、意大利、日本、马来西亚等 30 多个国家和地区的千万余用户提供完备的居所环境治理解决方案。

## 主要展品 /Products

从事各种生活电器的研发、制造、营销和服务等事业活动,多年来形成了以家用灭蚊器为主导的特色产品线,冬季以暖风机,加湿器,厨电类产品为主。

从事各种生活电器的研发、制造、营销和服务等事业活动,多年来形成了以家用灭蚊器为主导的特色产品线,冬季以暖风机,加湿器,厨电类产品为主。

## CUKO库可

## 佛山市功匠电器科技有限公司

E1-1G86

地址: <https://shop33898g5549190.1688.com/> (528300)

电话 /Tel: 0757-29293606

传真 /Fax: 0757-29212191

厂区介绍: 佛山市功匠电器科技有限公司,现有厂房面积 6700 平方,公司人员约为 150 人,坐落于顺德容桂,服务于线下渠道客户和电商客户, OEM 客户等。生产线 4 条,日产能约为 3000 台果汁机 / 条生产线,绞肉机 3000 台 / 条生产线;破壁机 1200 台 / 条生产线;能够满足电商、渠道、以及礼品的订单。

## 主要展品 /Products

果汁机;绞肉机;破壁机

## Upella

## 优百纳

## 佛山市冠盈金属塑料制品有限公司

E1-1D71

Top Profit Manufacturing Co., Ltd.

地址: 佛山市南海区九江镇九江工业园北一路 (528203)

Add: YuanBei 1st Road, JiuJiang Industrial Zone, JiuJiang Town, Nanhai District Foshan

Guangdong China

电话 /Tel: 0757-81860026

传真 /Fax: 0757-81860026

网址 /Web: <http://www.upella.com/>

Upella 优百纳专注于高端垃圾桶的设计与制造,每一个垃圾桶均由专业技师手工打造。荣获德国 IF、德国 RedDot 红点、美国 IDEA、意大利 A' Design 等多项国际设计大奖。全球累计销售超过 5200 万个垃圾桶,销售渠道覆盖 2800 多家国内线下门店以及各大电商平台。

Upella Home advocates the storage culture with the core connotation of integration.

We believe that trash can is not just a container for household or commercial rubbish, but also a piece of art which can be a harmonious element that adds colors to your space.

As the brand owner of Upella, Top Profit Manufacturing Co., Ltd. strives to bring you a satisfactory user experience by devoting to design and development of exquisite high-end trash can series.

Our excellent design, development and production capabilities are based on our 22 years of manufacturing experience. With the advanced production equipment and testing instruments, our OEM products are also sold in great volume worldwide to retail giants like Walmart, COSTCO, BED BATH & BEYOND etc.

Join our product revolution as we continuously challenge what is possible in your life and help bring awesomeness worldwide.

## 主要展品 /Products

智能感应垃圾桶、脚踏式垃圾桶、开口桶、茶水桶等不锈钢制品

Sensor Trash Can, Pedal Trash Can, Open Top Trash Can, Trash Can for Tea Cup etc.,

专业生产充电器 电源适配器  
产品种类: UL, CCC, TUV-CB, LVD, TUV-CB, ETL, TUV-CB, EMC, TUV-PSE, BSMI, TUV-CB, TUV-FCB, SAANANCO, ROHS, REE, 等认证**佛山市广源兴电子有限公司****Foshan Guangyuanxing Electronics Co., Ltd**

地址: 广东省佛山市顺德区大良街道飞翔路 18 号三层 (528300)

电话 /Tel: 13392269299

佛山市广源兴电子有限公司始于 2008 年, 是专业从事足功率、高安全 AC/DC、DC/DC 系列电源适配器、充电器 (锂电, 铅酸电池, 镍氢、镉等电池)、各类开关电源、防水电源研发和生产、销售为一体的工厂。产品涵盖 3W-2500W 各类小 \ 中 \ 大 \ 功率规格电源技术的生产厂家, 通过了 ISO9001 国际质量认证体系, 产品畅销全球, 全系列产品通过 CCC、CQC、UL、ETL、CE、PSE、SAA 等国际认证。

**主要展品 /Products**

电源适配器、充电器

**W4-4A37****佛山市国星光电股份有限公司****FOSHAN NATIONSTAR OPTOELECTRONICS CO.,LTD**

地址: 广东省佛山市禅城区华宝南路 18 号

Add: No.18 South Huabao Road, Chancheng District, Foshan, Guangdong, P.R. China

电话 /Tel: 0757-83985604

网址 /Web: www.nationstar.com

佛山市国星光电股份有限公司成立于 1969 年, 是广东省属国有独资重点企业广晟集团的控股上市公司, 专业从事研发、生产、销售 LED 及 LED 应用产品, 是国内第一家以 LED 为主业首发上市的企业, 也是最早生产 LED 的企业之一。经过 54 年的改革发展, 国星光电现已成为广晟集团电子信息板块的主力军、我国 LED 封装行业的龙头企业, 在全球 LED 封装行业占据重要地位, 组件产品为国际知名家电企业的核心战略供货商。

**主要展品 /Products**

1. 家用用小尺寸背光
2. 显示模块
3. 电视用大尺寸背光灯条
4. 控制板

1. Small Size Backlight for Appliances
2. Display Module
3. Large Size Backlight Strip for TV
4. Control Panel

**W3-3E61****佛山市汉秀创意设计有限公司****Foshan hanxiu Idea Design Co., Ltd**

地址: 广东省佛山市顺德区北滘镇天玑国际大厦 1007

电话 /Tel: 18033204876

网址 /Web: http://www.hanshowid.com/

2015 年在中国家电之都顺德成立, 是一家聚焦前沿科技研究, 提供策略咨询与创新设计开发于一体的设计服务型企业, 创始人和设计团队核心成员曾任职世界 500 强公司美的集团十余年。成立至今已累积斩获红点、IF、广东省长杯等多项国际国内大奖, 成功助力飞利浦、约克、科勒、开利、特灵、怡口、大宇、蓝宝、美的、海尔、TCL、万和等品牌产品设计, 上市产品 1000+。

Founded in Shunde, the capital of home appliances in China in 2015, it is a design service-oriented enterprise focusing on cutting-edge technology research, providing strategic consulting and innovative design and development. The founder and core members of the design team have worked for Midea Group, a Fortune 500 company, for more than ten years. Since its establishment, it has won many international and domestic awards such as Red Dot, IF, and Guangdong Governor's Cup, and successfully helped Philips, York, Kohler, Carrier, Trane, Yikou, Daewoo, Lambo, Midea, Haier, TCL, Vanguard And other brand product design, listed products 1000+.

**主要展品 /Products**

品牌策略咨询、用户研究、工业设计、结构设计、包装设计、UI 设计、产品开发。

Brand strategy consulting, user research, industrial design, structural design, packaging design, UI design, product development.

**佛山市华满诚拓家居用品有限公司**

地址: 广东省佛山市顺德区大良海悦新城 120 号

电话 /Tel: 15024282049

因为专注所以专业, 本公司本次展会重点展示定制行业一直备受青睐的高端嵌入式红酒柜和牛排柜以及雪茄柜, 其中有纯黑色系列, 纯白色系列以及定制门板全线条系列, 欢迎咨询来电, 期待与您进一步的交流洽谈, 谢谢!

**主要展品 /Products**

嵌入式红酒柜, 牛排柜, 雪茄柜

built-in wine cooler, dry ager, cigar cooler

**E2-2C51-10**

LIFECODE™

**佛山市活力源电子科技有限公司**  
**Foshan Lifecode Electronic Tech. Co., Ltd****E2-2B44 2B45**

地址: 佛山市顺德区勒流街道办事处江义村村委会江义大道东三路5号 (528322)

Add: Jiangyi Industrial Zone, Leliu,

电话 /Tel: 0757-23661362

传真 /Fax: 86-757-23661368

佛山市活力源电子科技有限公司创始于2006年,是一家集产品研发、生产、销售、服务于一体的专业化小家电制造企业,致力于为全球消费者提供高品质的优质生活电器。公司主要生产销售全自动家用冰淇淋机、超声波清洗机、家用多功能酸奶机、真空封口机、家用多功能面包机等精品健康电器。公司名称“活力源”是(Lifecode)莱科德的中文演绎名,主张简约时尚、健康创意的生活理念,更将这一理念融入产品的每个细微之处。

Foshan Lifecode Electronic Tech.Co.,Ltd is a professional high-tech household appliance manufacturer, which was found in year 2006. The main product is Ice Cream Maker, Vacuum Sealer, Ultrasonic Cleaner, Yogurt Maker and Bread Maker. All the products have got GS/CE(EMC,LVD)/PSE/ETL /FDA/LFGB/ROHS/CCC etc. And we successfully received BSCI and ISO9001:2015 International Quality Management System. To meet the market demand, we continuously develop the new items. In order to provide you full R&D service, the factory is equipped with the Design & Mock-up samples workshops and the Tooling & Testing machines for parts and finished products. Our products were exported to Japan, Europe, North and South America, Southeast Asia and Middle East, covers over 50 countries and regions. Lifecode tenet is "Quality & Innovation", which is the way we consider to success! Here ensure we will give you give you the best quality and the best service. Hope Lifecode is always your best choice!

**主要展品 /Products**

我司集研发、生产、销售于一体,主要产品:超声波清洗机、真空封口机、冰淇淋机、酸奶机、即热式饮水机、车载冰箱。

Ice Cream Maker, Vacuum Sealer, Ultrasonic Cleaner, Yogurt Maker and Bread Make

**九龙温控器**  
JIULONG THERMOSTAT
**佛山市九龙机器有限公司**  
**Foshan city Jiulong Machinery Co., LTD****W2-2A32**

地址: 广东省佛山市顺德区杏坛镇二环路智富园工业城6栋402 (528325)

Add: Room 402,Building 6,Zhifu Industry Zone,Second Ring Rd,Xing tan Town,Shunde

District,Foshan City,Guangdong Province,China.

电话 /Tel: 0086-0757-86289578

传真 /Fax: 0086-0757-86237770

网址 /Web: http://www.gd-jiulong.com

佛山市九龙机器有限公司是专业从事温控器、智能控制板、传感器、能量调节器及自动化设备研发制造的股份制企业。自创立以来,已拥有多项国家专利,参与起草了多项国家标准,已获得ISO9001:2008国际质量体系认证、ISO14001:2004国际环境体系认证以及CQC、CE、CB、VDE、

UL、TUV、BIS、ROHS、REACH等多项国内、国际安全认证和环保认证。

Foshan Jiulong Machinery Co., Ltd. is a joint-stock enterprise specializing in the R & D and manufacturing of temperature controller, intelligent control board, sensor, energy regulator and automation equipment. Since its establishment, it has owned a number of national patents, participated in the drafting of a number of national standards, and has obtained ISO9001:2008 international quality system certification, ISO14001:2004 international environmental system certification, CQC, CE, CB, VDE, UL, TUV, BIS, ROHS, reach and other domestic and international safety and environmental protection certification.

**主要展品 /Products**

温控器, 保护器, 档位开关, 传感器, 电控板等。

Thermostat, Protector, Rotary switch, Sensor, Electric control board.

**佛山市科桦电器有限公司**  
**Foshan Kehua Electric Appliance Co.,Ltd****N3-3B50**

地址: 佛山市南海区狮山镇罗村联和三洲朗工业区中区三路2号 (528226)

Add: No. 2, Zhongqu 3rd Road, Luocun Lianhe Sanzhoulang Ind. Zone, Nanhai Dist., Foshan, Guangdong, China

电话 /Tel: 13902800128

传真 /Fax: 0757-88771833

网址 /Web: fs-kehua.com

佛山市科桦电器有限公司成立于2010年12月,是一家专业生产KSD301系列突跳式温控器的国家高新技术企业。公司厂房面积4500㎡,现有员工90多人,拥有6条自动铆接和自动装配生产线,年产4200万只温控器,年产值约5500万元。产品广泛应用于咖啡机、微波炉、饮水机、挂烫机、奶瓶消毒器、养生壶、电炖盅等小家电产品,为多家世界著名家电企业提供质量稳定,性能可靠的温控器,在客户和业界赢得良好口碑。

Kehua company always adheres to the people-oriented management concept. With many senior engineers in the industry, first-class management personnel, and perfect management mechanism. In order to improve the quality of our products, we have introduced several latest generation of disc manufacturing automatic production lines from Austria, it is the most advanced technology in the world. Through the introduction of advanced equipment and technology, creative digestion absorption, to ensure product stability.

All important parts of the product are imported and used high quality materials, high precision, reliable performance, we have good partnership with excellent suppliers in the industry and to better serve customers.

**主要展品 /Products**

专业生产 KSD301 系列突跳式温控器

Kehua specializing in the production of snap action thermostats, the products are mainly used for temperature control and overheating protection of household appliances, such as water dispenser, electric water bottle, kettle, rice cooker, sterilizing, cabinets, refrigerators, dishwashers, microwave ovens, coffee makers, washing machines and ovens etc.



乐净  
LETING

## 佛山市乐净环保科技有限公司

E3-3B22

地址: 广东省佛山市顺德区容桂街道小黄圃社区创业路1号之二地块二座五层之一 (528305)

电话 /Tel: 0757-29262627

传真 /Fax: 0757-28363806

佛山市乐净环保科技有限公司是一家集研究、设计、制造、销售空气过滤网以及过滤方案、服务全球空气净化行业的品牌商和 OEM 厂商提供优质产品及全面解决方案。厂房总面积 10000 平方, 年生产量超过 500 万个各式过滤网产品。产品涵盖空气颗粒物过滤净化、空气抗菌防霉防过敏、除甲醛过滤网、光触媒过滤网、加湿网等, 产品广泛应用于家用商用空气净化器、新风系统及工业净化、医疗净化设备、轻轨高铁列车、汽车。

## 主要展品 /Products

产品涵盖空气颗粒物过滤净化、空气抗菌防霉防过敏、除甲醛过滤网、光触媒过滤网、加湿网等, 产品广泛应用于家用商用空气净化器、新风系统及工业净化、医疗净化设备、轻轨高铁列车、汽车。

楼氏电子科技  
LOUSHI ELECTRONICS

## 佛山市楼氏电子科技有限公司

W1-1A14

## Foshan Loushi Electronic Technology Co., Ltd

地址: 佛山市顺德区容桂街道同德智造园3栋602号 (528000)

Add: No. 602, Building 3, Tongde Zhizaoyuan, Ronggui Street, Shunde District, Foshan City

电话 /Tel: 13302833186

传真 /Fax: 0757-22900356

佛山市楼氏电子科技有限公司是一家集研发、生产、销售为一体的专业于温度传感器的生产型企业。楼氏公司位于“世界的家电制造基地”——佛山顺德, 公司成立于2003年, 经过十多年的成长, 目前已拥有颇具规模的自有生产厂房完整的生产检测设备; 并通过了ISO9001-2008质量管理体系认证, 产品完全符合欧盟 ROHS 环保指令。

Foshan Loushi Electronic Technology Co., Ltd. is a production enterprise specializing in temperature sensors that integrates research and development, production, and sales. Lou's company is located in Shunde, Foshan, the "world's home appliance manufacturing base". Founded in 2003, after more than ten years of growth, the company now has a considerable scale of its own production plants and complete production and testing equipment; We have passed the ISO9001-2008 quality management system certification, and our products fully comply with the EU ROHS environmental protection directive.

## 主要展品 /Products

温度传感器

Temperature sensor

MELTECH<sup>®</sup>  
HOME APPLIANCES

## 佛山市默尔电器有限公司

N1-1A36

## Foshan Mel-tech Electrical Appliances Co Ltd.

地址: 佛山市顺德区杏坛镇南华工业园2号C栋 (538305)

Add: No.30, Road 6, Qijiao industrial zone, Xingtan, Shunde, Foshan, Guangdong, China

电话 /Tel: 86-0757-27791331

传真 /Fax: 86-757-27793932

网址 /Web: www.mel-tech.com

佛山市默尔电器有限公司专业生产销售光波空气炉, 食物烘干机, 多功能锅, 电烤箱, 各项安规认证 CE CB CCC EMC LVD SAA LFGB ROHS BSCI ETL KC ERP PAHS REACH ISO9001:2008 齐全, 公司持续一来一直以高品质, 高效率, 最优惠的价格满足客户, 2016 年公司的光波空气销量在同行遥遥领先。

Mel-tech Electrical Appliance Co Ltd is a professional manufacturer for convection oven, food dehydrator, electric pressure cooker, salad maker and infrared cooker, focusing on product research, development, manufacturing and sales. Mel-tech owns not only industry-leading technology research, development and management team, but also the advanced equipment (including mold manufacturing, hardware and injection molding). Recently, Mel-tech has reached an annual production capacity of over five hundred thousand sets, with about 80 employees and two assembly lines. It's one of the professional convection oven and electrical pressure cooker manufacturing companies in China.

## 主要展品 /Products

光波空气炉、空气烤箱、多功能锅、干果机、烤肉机。

DHT 东华田  
DONGHUATIAN FRP WATER PURIFIER

## 佛山市南海区松岗东华田金属制品厂

W5-5A20

## Foshan Nanhai District Songgang Donghuatian Metal Products Factory

地址: 广东省佛山市南海区狮山镇石泉村石泉小海坦工业区6号东华田 (528234)

Add: Donghuatian, No. 6, Shiquan Xiaohaitan Industrial Zone, Shiquan Village, Shishan Town, Nanhai District, Foshan City, Guangdong Province

电话 /Tel: 0757-85224811

网址 /Web: https://fsdonghuatian.1688.com/

南海区松岗东华田金属制品厂是一家专业生产不锈钢净水器, RO 反渗透净水器, 挂壁式多滤芯净水器, 厨下式净水器, 中央净水器, 紫外线杀菌器等多款净水产品。公司拥有自主模具车间、注塑车间、五金车间、滤芯车间。在每个环节中都严格把控质量体系, 保证 100% 出厂合格率。资质认证方面办有国家卫生部颁发的涉水认证批件。

Nanhai Songgang Donghuatian Metal Products Factory is a professional manufacturer of stainless steel water purifiers, RO reverse osmosis water purifiers, wall mounted multi filter water purifiers, kitchen water purifiers, central water purifiers, UV sterilizers, and other water purification products. The company has independent mold workshops, injection molding workshops, hardware workshops, and filter element workshops. Strictly control the quality system in all aspects to ensure a 100% factory pass rate. In terms of qualification certification, there are water

related certification approvals issued by the Ministry of Health.

#### 主要展品 /Products

管道超滤机、外压式卡箍超滤机、龙头过滤器、全屋中央净水器、大流量反渗透纯水机、多级箱体式净水器、中大型紫外线杀菌器、磁化阻垢器、多级磁化净水器、10寸不锈钢滤瓶、20寸不锈钢滤瓶、韩式快接滤芯、韩式快卡滤芯,各种塑料零配件,各式定制式过滤器。

The main products include: pipeline ultrafiltration machine, external pressure clamp ultrafiltration machine, faucet filter, central water purifier in the whole house, large flow reverse osmosis water purifier, multi-stage box type water purifier, medium and large ultraviolet sterilizer, magnetization scale inhibitor, multi-stage magnetization water purifier, 10 inch stainless steel filter bottle, 20 inch stainless steel filter bottle, Korean quick connect filter element, Korean fast card filter element, various plastic parts, and various customized filters.



#### 佛山市诺伊达电器实业有限公司

W3-3H88 3H89

地址: 佛山市顺德区杏坛镇高赞工业区

电话 /Tel: 13703032791

网址 /Web: <http://www.zsdongtu.com>

中山市东图电器科技有限公司定位自主研发、整合制造业上下游资源,专注于空气净化器、空气消毒机、新风系统、车载除味器、智能家居小家电等健康智能产品的前沿发展;以敏锐的市场洞察力为基础,通过市场调研、产品分析、未来趋势评估、并配合完善的市场营销策略服务,与消费者需求深度对接;以市场需求为导向,不断推出具有自主知识产权的创新产品,以快打慢,产品潮流。

#### 主要展品 /Products

空气净化器,空气消毒机,新风系统,车载净化器,加湿器,香薰机,OEM/ODM 贴牌代工

#### 佛山市欧亿电器有限公司

W5-5C66

FoShan OE Electrical Appliance Co., Ltd.

地址: 广东佛山市南海区罗村乐安科华产业园 C 座 (528000)

电话 /Tel: 0757-82812890

传真 /Fax: 0757-82816355

网址 /Web: [www.fs-oe.com](http://www.fs-oe.com)

佛山市欧亿电器有限公司于 2006 年 10 月 15 日成立,主要生产经营温控器、保护器等产品,公司多年致力于产业,切实推进与各大企业、厂家的合资、合作,用产业化发展的思路服务于社会和广大用户。

佛山市欧亿电器有限公司,将在路上,与您同行共创辉煌!

#### 主要展品 /Products

温控器、保护器



#### 佛山市鹏兴智金属制品有限公司

N2-2B32

FOSHAN PENGXINGZHI METAL PRODUCTS CO., LTD

地址: 佛山市顺德区勒流镇众涌工业区 7-1 号之三 (528323)

Address: No.7-1 Plant 3, Zhongyong Industry Area, Leliu Town, Shunde District, Foshan City, Guangdong Province

电话 /Tel: 0757-23660790

网址 /Web: <http://www.pxzhardware.com/>

鹏兴智金属制品成立于 2014 年,坐落于佛山市顺德区,占地 5000 平方米。是一家专业设计、生产、销售于一体的五金配件制造型企业,主营电器拉手、旋钮、饰条等精密金属连接件,应用于家电、家具等领域。

公司拥有一支强有力的人才队伍,能独立开发生产各类型高品质产品,不断引进自动化设备。凭精湛的工艺与完善的售后服务,深受国内外客户的信赖。

我们将继续坚守“求实创新,共创品牌”的理念,致力打造高品质的产品。

Pengxingzhi Metal Products Co., Ltd is established in 2014, and located in Shunde, Foshan, covers an area of 5000 square meters. It's a professional design, production, sales on one way hardware accessories manufacturing enterprises, we specialized in appliance handles, knobs, frame Garnish and other precision metal connectors, the products are mainly used in the home appliance, furniture and other fields.

Our factory own a team of powerful management, and concentrate on developing&producing high quality products, constantly introducing advanced automation equipment. In the competitive market, relying on the philosophy of quality orientation and the constant improvement, support OEM/ODM, independent design and R&D team.

We will continue to abide by the "realistic innovation, create a brand" concept, is committed to creating high quality products. Welcome friends of all circles provide samples and design drawing for processing or call us for detailed information.

#### 主要展品 /Products

拉手, 旋钮, 装饰框, 铝制品

handle, knob, frame Garnish, aluminum products



#### 佛山市奇门设计顾问有限公司

E2-2C51-07

地址: 广东省佛山市顺德区北滘镇天宁路 5 号铂富中心 23A 层 11-14 单元

电话 /Tel: 13380289868

佛山市奇门设计顾问有限公司 (2015- 至今), 位于顺德北滘, 在【先行研究】、【工业设计】、【品牌设计】三大专业板块的联动之下, 团队以输出完整的、持续的、可迭代的创意方案为其核心业务。经数年的探索与发展, 团队已涉足家电、生活用品、餐饮、制造业、教育、公益等多个领域, 项目横跨国内、日韩、北美、中亚等地区, 成功为不同领域与不同区域的合作方提供从【调研分析】、【原型创新】至【成果转化】的完整服务。

#### 主要展品 /Products

高速吹风机、古典氛围灯、可穿戴空气消杀口罩、电热分体锅、全可视空气炸锅

RATOP  
DESIGN

睿拓设计

佛山市睿拓工业设计有限公司

E2-2C51-03

Foshan Ratop Industrial Design Co., Ltd.

地址: 广东省佛山市顺德区北滘镇设计城居委会蓬莱路 88 号设计城三期西座 5 楼

Add: 5th Floor, West Building, Design City Phase III, No. 88 Penglai Road, Design City

Neighborhood Committee, Beijiao Town, Shunde District, Foshan City, Guangdong Province

电话 /Tel: 18924895648

网址 /Web: http://www.ratop-id.com/

睿拓设计创立于 2010, 提供从调研咨询、品牌策略、产品设计、供应链整合、营销策划的全案知识服务; 深耕的领域包含: 厨房及环境电器、理疗及医美仪器、商用机械设备、美妆个护等产品; 累计上市项目总量 1000+, 客户委托及自主研发的专利技术累计过 3000+, 团队累计斩获红点、iF、红星等国内外设计多项大奖, 合作的国内知名企业、国外大型公司的成功产品案例, 设计辐射价值累计超过十亿美元。

Ratop Design was founded in 2012. Since its establishment 11 years ago, Ratop Design has won many domestic and foreign design awards such as Red Dot, iF, and Red Star. It has successfully served thousands of design and marketing projects for well-known domestic companies and large foreign companies. The business has penetrated into the fields of kitchen appliances, cultural creativity, mechanical equipment, physical therapy and health care, medical health, personal care and other fields; the total number of listed projects has exceeded 5,000. Ratop Design takes "creating good products" as its core value, and is committed to providing category-innovative consulting and design services for customers in vertical industries.

## 主要展品 /Products

深耕的领域包含: 厨房及环境电器、理疗及医美仪器、商用机械设备、家居及户外工具、美妆个护及数码电子等产品

The fields of deep cultivation include: kitchen and environmental appliances, physiotherapy and medical beauty equipment, commercial machinery and equipment, home and outdoor tools, beauty and personal care and digital electronics and other products



三人一物

佛山市三人一物工业设计有限公司

E2-2C51-09

地址: 佛山市顺德区北滘镇设计城居委会三乐路北 1 号设计城二期东座 6 楼 603A 室

电话 /Tel: 18520929915

网址 /Web: http://www.design3.cn.com/

三人一物工业设计是由三位资深设计师联合创立, 位于家电重镇广东顺德。志在通过丰富的系统化的工业设计创新能力为客户提升商品竞争优势、创造新的市场、提高品牌知名度。

公司曾获得多项国内外设计大奖并有多项设计作品在市场表现优异。三人一物尤其擅长空气类产品, 核心成员具有 15 年以上的空气类产品设计经验。目前服务过的空调类产品客户有美的、松下、开利、奥克斯。

## 主要展品 /Products

空调, 净化器, 加湿器

SDI  
世鼎科技

ShiDing Industry

佛山市世鼎科技有限公司

E2-2B32

Foshan Shiding Technology Co., Ltd.

地址: 广东省佛山市顺德区杏坛镇高赞村二环路 8 号顺德智富园 17 栋 701-704 (528325)

Add: Unit 701-704, 17th Building, Shunde Zhifuyuan Industrial Park, Xingtian Town, Shunde

District, Foshan City, Guangdong, China

电话 /Tel: 13822716962

网址 /Web: https://sdikj.en.alibaba.com/

主营 OEM/ODM 代工, 专注于护眼产品的研发、生产。

与国内外众多知名品牌达成深度合作关系。拥有多项自主知识产权的创新产品, 引领行业潮流。

从 2020 年开始, 已实现月产能 5 万台流水线三条, 计划每年开发不低于 10 款全新的产品, 以满足市场需求。

世鼎科技牢记产品品质就是企业的生命力, 现已通过 FDA、FCC、CE、ICID、ROHS、REACH、TELEC、RCM 等十多项国际产品质量认证。

## 主要展品 /Products

眼部按摩仪、护眼仪、美眼仪



## 弘金电器

佛山市顺德弘金电器科技有限公司

E1-1H51

Shunde Kingtec Appliances Co., Ltd.

地址: 广东省佛山市顺德区北滘镇马龙村现龙工业区防洪路西侧 (528311)

电话 /Tel: 0757-23272303

网址 /Web: www.sdkingtec.com

佛山市顺德弘金电器科技有限公司创建于 2013 年, 是一家集研发、制造、销售和服务于一体的专业小家电制造企业, 产品涵盖电风扇, 电暖器和加湿器三大类。占地 3.5 万平方米, 现有 500 多名员工。弘金电器不断提升企业国际化水平, 实现智能化生产, 拥有精益生产流水线 10 条, 企业产量高达 400 万台, 产值超过 4 亿。公司下设顺德弘金科技工厂和宏富电器科技有限公司, 于 2018 年荣获国家高新技术企业。

Shunde Kingtec Appliances Co., Ltd. was founded in 2013. It is a professional small household appliance manufacturing enterprise integrating R&D, manufacturing, sales and service. Its products cover three categories: electric fans, electric heaters and humidifiers. It covers an area of 35,000 square meters and has more than 500 employees. Hongjin Electric continues to improve the internationalization level of the company and realize intelligent production. It has 10 lean production lines, and the company's output is as high as 4 million units, with an output value of more than 400 million. The company consists of Shunde Hongjin Technology Factory and Hongfu Electrical Technology Co., Ltd., which were awarded the National High-tech Enterprise in 2018.

## 主要展品 /Products

加湿器、电暖器、电风扇

Humidifier, heater, fan



**佛山市顺德区飞湃科技有限公司**  
**FoShan ShunDe Feipai Technology Co. Ltd.**

**W5-5A25**

地址: 佛山市顺德区勒流镇勒流港集约工业区二期 C06-1 号  
电话 /Tel: 18998315926

佛山市顺德区飞湃科技有限公司成立于 2021 年 9 月, 隶属于广东福田电器有限公司, 独立运营小家电事业, 与福田电器携手共创家电神话, 我们致力于高新不高价的小家电创新技术, 专精于开发地面清洁、衣物护理和环境家电类产品开发和生产。

**主要展品 /Products**

蒸汽拖把, 蒸汽熨斗, 电火锅, 净化器, 宠物用品生产制造。



**佛山市顺德区富升电子科技有限公司**  
**FOSHAN SHUNDE FUSEN ELECTRONIC TECHNOLOGY CO., LTD**

**E2-2A02**

地址: 广东省佛山市顺德区容桂街道天富来工业区 5 期 10 座 702  
Add: No.702 block 10 No.5 of Tian Fu Lai Industrial Park, Ronggui, Shunde District, Foshan City,  
Guangdong Province of China 528305  
电话 /Tel: 0757-22909021  
网址 /Web: www.icookmix.com

佛山市顺德区富升电子科技有限公司成立于 2012 年, 是一家集研发、设计、生产、销售于一体的智能家电制造商。我们提供 OEM 和 ODM 服务, 在这方面拥有超过 10 年的经验。在公司的发展过程中, 我们始终坚持不断创新、勤于探索, 先后荣获高新技术种子企业称号。

如今, 我们的工程团队拥有强大的技术及产品研发能力, 专注于开发多功能智能厨房家电产品, 并为来自中国及欧美多国客户提供 ODM 项目研发服务。

Foshan Shunde Fusen Electronic Technology Co., Ltd. established in 2012, We are a professional manufacturer of home appliances, integrating R&D, design, production and sales. We do offer OEM & ODM service and we have had more than 10 years experience on it. Nowadays, We have an experienced engineering R&D team focusing on our main product: Smart Multifunctional Food Processors and other Smart Kitchen items, also taking care of the ODM project for our customers from Europe, America and many other countries.

**主要展品 /Products**

多功能食物料理机, 厨师机, 搅拌机。

Multifunctional food processor, Thermo-mixer blender, Chef robot.



**佛山市顺德区格明电器实业有限公司**  
**Foshan geming Electric Industrial Co., Ltd**

**N1-1B26**

地址: 佛山市顺德区容桂街道办幸福工业区汇荣路 4 号首层 (528305)  
Add: 1st Floor No.4, Huirong Road, Xinfu Neighbourhood Committee, Shunde District, Foshan,  
City, Guangdong Province, Postal: 528305  
电话 /Tel: 0757-28996380  
网址 /Web: http://www.sdgeming.com/

佛山市顺德区格明电器实业有限公司位于大湾区的黄金腹地, 具有“家电王国”之称的顺德。公司成立于 2005 年 7 月, 前身为锐艺模具厂。2007 年正式更名为格明电器, 是一家专业生产电煮锅、空气炸锅、榨汁机、搅拌机、破壁机、生活电器等产品的前沿企业。有“格明”和“格源”俩大品牌。

Foshan Shunde Geming Electric Appliances Industrial Co., Ltd. is located in the golden hinterland of the Greater Bay Area, which is known as "the Kingdom of home appliances". The company was established in July 2005, formerly known as Rui Yi Mould Factory. In 2007, it was officially renamed as Geming Electric Appliances. It is a cutting-edge enterprise specializing in the production of soy milk maker, electric cooker, air fryer, juicer, blender, high speed blender, household appliances and other products.

**主要展品 /Products**

电煮锅、空气炸锅、榨汁机、搅拌机、破壁机, 果汁机, 果汁杯, 沙冰机。

Electric cooking pot, Air fryer, Ice crusher, Blender, Juicer,



**佛山市顺德区古今工业设计有限公司**  
**Foshan Shunde Gujin Industrial Design Co., LTD**

**E2-2C51**

地址: 广东省佛山市顺德区北滘镇三乐路北 1 号设计广场西座 4 楼 403B 室  
Add: Room 403B, 4th Floor, West Block, Design Plaza, No. 1, North Sanle Road, Beijiao Town,  
Shunde District, Foshan city, Guangdong Province  
电话 /Tel: 0757-22397738  
网址 /Web: http://www.gjldcn.com/

古今工业设计成立于 2005 年, 是广东省高新技术企业、佛山市设计创新能力示范单位、顺德区工业设计重点机构。19 年来荣获 68 项各类产品设计奖项, 2500+ 成功上市案例。为小熊电器累计完成 1518 项、爆款 49 项, 助推小熊电器成功上市。深耕领域包括大小家电, 户外露营, 电子产品, 美妆个护等。为企业提供优质的创意落地, 项目孵化及深度合作, 资源整合。期待与客户合作共赢, 创造更多超级爆品!

Established in 2005, Ancient and Modern Industrial Design is a high-tech enterprise in Guangdong Province, a demonstration unit of design innovation capability in Foshan City, and a key institution of industrial design in Shunde District. Over the past 19 years, it has won 68 various product design awards and more than 2500 successful marketing cases. Completed a total of 537 items and 129 hot items for Xiaoxiong Electric, which helped Xiaoxiong Electric successfully



go public. Deeply cultivated fields include household appliances, outdoor camping, electronic products, beauty and personal care, etc. Provide high-quality creative landing, project incubation, in-depth cooperation, and resource integration for enterprises. Looking forward to win-win cooperation with customers to create more super explosives!

#### 主要展品 /Products

1. 智能空气炸锅
  2. 可视空气炸锅
  3. 轻音破壁机
  4. 养生壶
  5. 微压快炖电炖锅
  6. 电蒸锅
  7. 加湿器
  8. 热泵地暖机
  9. 烘鞋暖脚器
  10. 国内首款旅行干衣盒
  11. 抽真空零食盒
  12. 盒式消毒电热水袋
  13. 便携小火锅
  14. 轻音养生壶
  15. 隔水炖
  16. 双灶电煮锅
1. Smart air fryer
  2. Visible air fryer
  3. Smoothies with Sound Proof Cover Professional Blender
  4. Health pot
  5. Micropressure ceramic electric stewpot
  6. Electric steamer
  7. Humidifier
  8. Heat pump
  9. Multifunctional shoe dryer and foot warmer
  10. The first travel dryer in China
  11. Vacuum snack box
  12. Box type electric heating water bag
  13. Portable small hot pot
  14. Health pot
  15. Ceramic Stew Cooker
  16. Multifunctional electric hot pot



古今设计  
GOOD DESIGN

佛山市顺德区古今工业设计有限公司  
Foshan Shunde Gujin Industrial Design Co., LTD

地址: 广东省佛山市顺德区北滘镇三乐路北1号设计广场西座4楼403B室  
电话 /Tel: 13823455250  
网址 /Web: <http://www.gjdcn.com/>

E2-2C51-11

古今工业设计成立于2005年,是广东省高新技术企业、佛山市设计创新能力示范单位、顺德区工业设计重点机构。19年来荣获68项各类产品设计奖项,2500+成功上市案例。为小熊电器累计完成537项、爆款129项,助推小熊电器成功上市。深耕领域包括大小家电,户外露营,电子产品,美妆个护等。为企业提供优质的创意落地,项目孵化及深度合作,资源整合。期待与客户合作共赢,创造更多超级爆品!

Established in 2005, Ancient and Modern Industrial Design is a high-tech enterprise in Guangdong Province, a demonstration unit of design innovation capability in Foshan City, and a key institution of industrial design in Shunde District. Over the past 19 years, it has won 68 various product design awards and more than 2500 successful marketing cases. Completed a total of 537 items and 129 hot items for Xiaoxiong Electric, which helped Xiaoxiong Electric successfully go public. Deeply cultivated fields include household appliances, outdoor camping, electronic products, beauty and personal care, etc. Provide high-quality creative landing, project incubation, in-depth cooperation, and resource integration for enterprises. Looking forward to win-win cooperation with customers to create more super explosives!

#### 主要展品 /Products

1. 智能空气炸锅
  2. 可视空气炸锅
  3. 轻音破壁机
  4. 养生壶
  5. 微压快炖电炖锅
  6. 电蒸锅
  7. 加湿器
  8. 热泵地暖机
  9. 烘鞋暖脚器
  10. 国内首款旅行干衣盒
  11. 抽真空零食盒
  12. 盒式消毒电热水袋
  13. 便携小火锅
  14. 轻音养生壶
  15. 隔水炖
  16. 双灶电煮锅
1. Smart air fryer
  2. Visible air fryer
  3. Smoothies with Sound Proof Cover Professional Blender
  4. Health pot
  5. Micropressure ceramic electric stewpot
  6. Electric steamer
  7. Humidifier
  8. Heat pump
  9. Multifunctional shoe dryer and foot warmer
  10. The first travel dryer in China
  11. Vacuum snack box
  12. Box type electric heating water bag
  13. Portable small hot pot
  14. Health pot
  15. Ceramic Stew Cooker
  16. Multifunctional electric hot pot

**SANBOEN**®  
DISPLAY**佛山市顺德区恒维电子科技有限公司**  
**Kingway (Foshan) Electronic Technology Co.Ltd**

W5-5B01

地址: 广东省佛山市顺德区杏坛智富园 30 栋 2 号门 4 楼 (528306)

电话 /Tel: 075728375716

网址 /Web: www.sanboen.com

佛山市顺德区恒维电子科技有限公司成立于 2012 年 9 月, 公司主营业务显示模组、光学触摸及光学导光、TFT 智能显示 +AI、人机交互、IOT 应用等显示解决方案及各种显示模组产品技术开发, 生产与销售的研发型企业, 2019 年获得广东省高新技术称号。公司专注于人机交互解决方案, 实现智能显控 +AI 的应用的跨越, 涉及到智能家电、新能源、金融机具、工程机械、医疗仪器等领域提供整体解决方案。

**主要展品 /Products**

显示模组、光学触摸及光学导光、TFT 智能显示 +AI、人机交互、IOT 应用等显示解决方案及各种显示模组产品。

**宏翼設計**  
HONGYI INDUSTRIAL DESIGN**佛山市顺德区宏翼工业设计有限公司**  
**FOSHAN HONGYI INDUSTRIAL DESIGN CO.,LTD**

E2-2C51-08

地址: 佛山市顺德区北滘镇工业设计城 N 栋一楼 (528311)

Add: N-1, Sanle Road, Beijiao Town, Shunde District, Foshan City

电话 /Tel: 13825529746

网址 /Web: www.oe-innovation.com

宏翼设计创立于 2005 年, 总部位于世界家电制造重镇——广东顺德, 是国内优秀产品创新设计机构, 有 1000 余项产品设计案例积淀, 服务涵盖产品策略、产品设计、基础研究、技术工程等范畴。

创新, 是宏翼成长的动力。我们相信即使通过设计实现细微的创新和改良, 也可以带来前所未有的使用体验。

探索, 宏翼从未停下脚步。从 05 年宏翼成立, 为企业提供设计服务, 到建立自主品牌, 我们不断探索, 努力打造全产业链的服务支持。

OE Industrial Design Co.,Ltd was founded in 2005 and the headquarters is located in the appliance manufacturing center of the world——Shunde,Guangdong,which is the excellent domestic product innovation design institute. It is a professional innovation team with over 60 people and has provided more than 1000 product design cases so far.The design service of OE covers product strategy, product design, basic research, technical engineering, supply chain support, etc..

Creativity, the motive power of oè

We believe that even some small innovation and improvement made through design can provide unprecedented using experience

Exploration, oè never stops

oè was established in 2005 and provide design service for many well-known enterprises like Phillip and GE. Then oè established self-owned brand. We will constantly explore new ways and make efforts to build the whole industry chain support for design service.

**主要展品 /Products**

这是一系列为客户设计的小家电产品, 虽然是不同客户的品牌, 包含电火锅等厨房电器、加湿除湿器等环电产品等多品类, 设计师通过整体色彩和材质的搭配, 形成了统一的视觉效果。

一款为差旅或个人设计的便携小火锅, 把手和盖子小提手折叠设计, 分离式加热底座不用时可收纳进锅胆内, 适合家用或外出旅行使用。

全新低糖功能, 采取白米与水分分离蒸煮的方法, 为有减低糖分需求的用户提供高效低糖的饮食。

This is a series of small household electrical appliances designed for customers. Although they are brands of different customers, including kitchen appliances such as electric hot pot, environmental electrical products such as humidifier and dehumidifier.The designer has formed a unified visual effect through the matching of overall color and material.

A portable pot designed for personal use, which can be used in home or outside. Folding handle does not take up space. The heating plate base can be put into the pot for storage.

With de-sugar function it can separate rice from water while cooking to reduce sugar in rice effectively. In this way it will not damage nutrients and provide low-sugar diet for users.

**佛山市顺德区环威电器有限公司**  
**Foshan Wellway Electric Appliance Co., Ltd.**

N1-1B19

地址: 广东省佛山市顺德区容桂街道华口昌宝东路 11 号 (528300)

Add: No. 11 Chang Bao Dong Road, Huakou Community, Foshan, Guangdong, China

电话 /Tel: 86-757-28881028

传真 /Fax: 86-757-28881038

网址 /Web: https://www.wellway-welux.cn/

环威电器有限公司成立于 1997 年, 是国内应用扩散 - 吸收式制冷技术生产、销售酒店客房环保静音冰箱的企业。经过多年发展, 环威冰箱现已成为国内最畅销的客房冰箱。在制冷技术领域拥有超过 20 年的设计和研发经验, 成功开发出包括吸收式、压缩机制、电子半导体式、热管式多种制冷方式的冰箱产品。

公司现有厂房面积 2.5 万平方米, 员工 250 人, 拥有先进生产及检测设备。与全球著名品牌开展了数十载的 OEM 定制产品服务。

WELLWAY Electric Appliance Co., LTD. was founded in 1997, we were the first company in China to produce and sell absorption type guest room minibar. As we mastered this leading world technology in cooling industry, WELLWAY participated in formulating the "Industrial standard for absorption refrigerators of the People's Republic of China". After 20 years of focusing on technology and marketing development, WELLWAY has been becoming the best-selling guest room minibar brand in Chinese market and we has various types of products, including absorption, compressor, semiconductor and thermoelectric fridges, offers different kinds of options to our clients.

Our factory is over 25000 square meters and with more than 200 employees. To have better quality control, there are numerous advanced production and testing equipment in our factory, up to 96% of spare parts are produced by ourselves.

**主要展品 /Products**

复古冰箱, 抽屉冰箱, 迷你冰箱, 红酒柜

retro refrigerator, drawer minibar, mini bar fridge, wine cooler

**佛山市顺德区科霸菱电机有限公司**  
**KBL MOTOR CO.,Ltd**
**N1-1B41**

地址: 广东 佛山 顺德 均安镇 社区居委会 智安北路 23 号 (528329)  
 Add: No. 23 North Zhian Road, Jun'an Town, Shunde, Foshan, Guangdong, China  
 电话 /Tel: 0757-25575938  
 传真 /Fax: 0757-25576103  
 网址 /Web: www.kbl-motor.com

公司是中国专业生产家用电器用电机的最大的生产厂家之一, 拥有从日本引进的高速冲床 5 台及其他设备仪器 500 多台套。

冰箱、冷柜用电机是本公司的拳头产品, 我们正在为创造世界第一品牌而奋斗。

经多年不懈地努力, 我们以优良的产品质量、热情周到的服务, 使产品畅销世界各地, 被许多著名的大公司所采用, 如三洋、松下、伊莱克斯、科龙、海尔、华凌、格力、TCL 等。

The company is one of the biggest manufacturers of motors for home electrical appliances in China. It owns 5 sets of high-speed punches imported from Japan, more than 500 sets of other equipment.

Especially the motors used for refrigerators and fridges are the best products in the company, we are all striving hard for creating the 1st brand in the world.

With great efforts for years, the company is able to offer high quality products and excellent services, which satisfy the customers all over the world. The products are widely used by many famous companies such as Sanyo, Panasonic, Electrolux, Kelon, Haier, Hualing, Gree, TCL, etc.

**主要展品 /Products**

主要生产罩极电机、减速箱、电容运转电机、直流无刷电机等 300 多种型号的产品。

Its main products are shaded-pole motors, gearboxes, single-phase capacitor motors, BLDC motors, including over 300 models and specifications.



创新·务实·互助·共享

**佛山市顺德区酷福电器有限公司**  
**FOSHAN SHUNDE KUFU ELECTRIC APPLIANCES CO.,LTD.**
**N2-2A54**

地址: 佛山市顺德区容桂华口居委会华口聚龙工业区昌宝东路之 2-1 二层、三层 (528300)  
 Add: 2-1, 2nd and 3rd Floor, Changbao East Road, Huakou Industrial Zone, Ronggui Huakou  
 Neighborhood Committee, Shunde District, Foshan City  
 电话 /Tel: 0757-22136026  
 网址 /Web: WWW.sdkufu.com

佛山市顺德区酷福电器有限公司成立于 2011 年 3 月, 总部坐落于广东顺德, 拥有容桂、杏坛两个生产基地, 年产值达 6~10 亿, 集研发、生产、销售为一体的制造型民营企业。公司主要生产智能电饭煲、空气炸锅、空气烤箱等多种电动、电热类厨房电器产品, 产品远销全球 30 多个国家和地区。

Foshan Shunde Kufu Electric Appliance Co., Ltd. was founded in March 2011, headquartered in Shunde, Guangdong Province, with Ronggui, Xingtian two production bases, annual output value

of 600 ~1 billion, set research and development, production, sales as one of the manufacturing private enterprises. The company mainly produces intelligent rice cookers, air fryers, air ovens and other electric and electric kitchen appliances, which are exported to more than 30 countries and regions around the world.

**主要展品 /Products**

空气烤箱、空气炸锅、电饭煲等厨房小家电。  
 Air oven, air fryer, rice cooker and other small kitchen appliances.

**佛山市顺德区欧开威电器有限公司**  
**Foshan City Shunde District Oukaiwei Electric Appliance Co., Ltd.**
**W3-3H72 3H73**

地址: 广东省佛山市顺德区均安镇沙浦大道 3 号 (528329)  
 电话 /Tel: 18123542956  
 传真 /Fax: 0757-25592858

欧开威公司是一家集研发、生产、销售为一体的现代化科技型企业。专业致力于健康生活电器终端产品应用技术研发、健康厨房电器整体解决方案, 提供家庭健康养生全管理。产品有家用榨油机、玻璃养生锅、车载旅行 / 二合一电热杯、电热壶健康生活电器。

**主要展品 /Products**

欧凯威玻璃养生锅: 高硼硅玻璃内胆 智能调节火候 煮炖一键完成。  
 新增都饭功能, 大功率快 / 慢自由操控。  
 欧凯威家用榨油机: 智能操作 高效出油 独家设计连体翻盖专利技术  
 欧凯威电热旅行壶 / 电热杯  
 欧凯威玻璃多功能养生壶



通昊电器

**佛山市顺德区通昊电器有限公司**  
**FOSHAN SHUNDE MAXCAN ELECTRICAL APPLIANCES CO.,LTD**
**W5-5B12**

地址: 广东省佛山市顺德区杏坛工业区科技区十路 2 号 (528325)  
 Add: 2-10Rd Technology Zone, XingTan Industrial Park, Shunde, Guangdong, 528325 China  
 电话 /Tel: 0757-26361789  
 传真 /Fax: 0757-26361081  
 网址 /Web: www.maxcan.net.cn

佛山市顺德区通昊电器有限公司成立于 2007 年。是一家集超声波加湿器研发、生产、销售、售后服务于一体的工厂。我们的工厂位于中国顺德, 靠近香港和深圳港口。便利的交通使我们的产品可以运送到世界各地的客户。我们的销售网络遍布美国、欧洲、日本、韩国等多个国家和地区。我们始终秉承“品质完美, 客户满意”的原则, 发扬诚实、和谐、守信的原则, 在 OEM 和 ODM 领域发展壮大。

Foshan Maxcan Electrical Appliance Co., Ltd was established in 2007. It is a professional manufacturer with ISO9001 and BSCI certificate that integrates development, production, sales and after-sales service of ultrasonic humidifiers. Our factory locates in Shunde, China, where is very close to Hongkong port and Shenzhen port. The convenient transportation allows us to ship our products to customers all over the world at a reduced rate. We have built our sales network

spreading over most countries and districts such as US, Europe, South America, Middle East, Japan & Korea, etc. All of our products have obtained GS, CE, CB and RoHS certificates from SGS and ETL, CETL from Intertek. We always uphold the principle of "perfection of quality and satisfaction of customers", and carry forward the principles of sincerity, honesty, harmony, and trustworthiness to develop and expand in the OEM and ODM fields.

#### 主要展品 /Products

加湿器, 香薰机

Humidifier, Aroma humidifier



#### 佛山市顺德区唯点工业设计有限公司 Vee Design Consulting Co.,Ltd.

E2-2C51-13

地址: 广东省佛山市顺德区北滘镇广东工业设计城 C 栋 1 楼 veedesign (528300)

Add: 1st floor, Block C, Guangdong Industrial Design Park, Beijiao Town, Shunde District, Foshan.

电话 /Tel: 18022722200

网址 /Web: www.veedesign.cn

坐落于广东工业设计城的唯点设计 (VeeDesign) 成立于 2015 年广东省高新技术企业, 是一家专业的产品设计开发公司, 服务涵盖用户研究、产品策略、产品设计、结构设计、设计咨询五大创新服务模块。通过打造专业的设计团队, 探索消费者的行为习惯和使用场景, 为客户打造年轻化设计, 赢得包括 RedDot、IF 等国内外知名设计奖项成为业内最有活力和竞争力的创新团队。

VeeDesign, based in Guangdong Industrial Design City, was founded in 2015 as a high-tech enterprise in Guangdong Province. It is a professional product design and development company with five innovative service modules that include user research, product strategy, product design, structural design, and design consulting. VeeDesign has won domestic and international design awards, including RedDot and IF, for creating a professional design team, exploring consumer behavior and usage scenarios, and creating youthful designs for clients, and has become the most dynamic and competitive innovation team in the industry.

#### 主要展品 /Products

唯点设计服务多家世界五百强和中国五百强企业, 拥有超过 300 个上市案例, 多个案例成为爆款和客户当年重点产品, 使客户利益最大化; 服务范围包括: 用户研究、产品策略、产品设计、结构设计、设计咨询, 为客户打造多元化、年轻化爆款产品。

Veedesign serves many Fortune 500 and Chinese Fortune 500 companies and has over 300 listed cases, many of which have turned into pop-ups and key products of the year for customers to maximize their benefits; services include: user research, product strategy, product design, structural design, design consulting, and creating diverse and youthful pop-up products for customers.



E-Motor

#### 佛山市顺德区伊默特电机有限公司 FOSHAN SHUNDE E-MOTOR CO.,LTD.

W4-4B12

地址: 广东省佛山市顺德区均安镇智安北路 2 号 (528309)

Add: 2nd Floor, Block 6, no.2, Zhian north road, Jun'an Town, Shunde District, Foshan City, Guangdong P.R. China

电话 /Tel: 0757-25517555

传真 /Fax: 0757-25514567

网址 /Web: www.sdemotor.com

佛山市伊默特电机有限公司是一家专业生产、研发微型电机的公司, 公司位于顺德区均安镇。紧邻国际武打巨星李小龙的故居。公司主营罩极电机、贯流风机、横流风机、串激电机、同步电机、电容电机。产品广泛用于电壁炉、取暖器、微波炉、电风扇、冷柜、空调器、光波炉、排气扇、烤箱、空气清新机、按摩器、搅拌机等等家用电器和其它领域的电气产品上。

Foshan Shunde E-Motor Limited Corporation Introduction

Foshan Shunde E-Motor Limited Corporation is located in Adlo Industrial Zone, Jun'an Town, Shunde District, Foshan City, Guangdong Province, China. The company is specialised in shaded pole motors, cross flow blowers, ventilators, universal motors, capacitor motors and so on, which are mostly used in electrical fireplace, refrigerators, freezers, microwave ovens, warm air blowers, exhausted fans, baking ovens, air cleaners, massagers, etc.

#### 主要展品 /Products

罩极电机、贯流风机、横流风机、串激电机、同步电机、电容电机。

Shaded pole motors, cross-flow fans, cross-flow fans, series motors, synchronous motors, capacitor motors.



#### 佛山市炜皓电器科技有限公司

#### FOSHAN SUNRAYS ELECTRICAL TECHNOLOGY CO., LTD

E2-2B43

地址: 广东省佛山市顺德区杏坛镇齐杏社区杏坛工业科技二路 2 号威和新科园 2 栋 902 之二

Add: Unit 902-2, Building 2, Weihe Industrial park, Keji zone 2 Road, Qixing Community, Xingtian Town, Shunde District, Foshan, Guangdong, China

FOSHAN SUNRAYS ELECTRICAL TECHNOLOGY CO.,LTD is a professional supplier of metal fan series and plastic fan series. Our main market is Europe Area, SE Asia South America and domestic market.

Our factory is located at Shunde district, Foshan city, Guangdong, PR China. Factory have our own injection workshop, metal punching workshop, motor workshop and 4 production assembly lines. We have engineer 5 persons; QC 10 persons and 100 persons of labour. Production capacity is 800K units per year. We are also welcome OEM development since we have our skillful engineering teams.





**佛山市天朋温控器有限公司**  
**FoShan TianPeng Thermostats Co., LTD**

**N4-4A20**

地址: 佛山市南海区丹灶镇银河工业区1号(528216)

Add: NO.1 Building, Yinhe Industrial Zone, Danzao Town, Nanhai District, Foshan City, Guangdong, PRC.

电话 /Tel: 13380296960

传真 /Fax: 075785413770

网址 /Web: <http://www.tpsensor.com>

佛山市天朋温控器有限公司成立于1996年。天朋始终致力于“提供控温精确、安全可靠的双金属温控器，为客户持续创造价值”。20多年来专注于温控器研发和制造，天朋是自动控制器件国家标准的起草单位之一。服务客户有美的、格力、惠而浦等全球知名品牌。连续多年行业占比前三，年出货量1.6亿多只，出口多达20多个国家和地区。产品覆盖电流10A~60A，温度-32°C~270°C，应用在各类家电、打印机及汽车等各种领域。

Foshan Tianpeng Thermostat Co., Ltd. was established in January 1996 and is located in Foshan City. Since its establishment. For more than 20 years, we have focused on the development and manufacturing of thermostats, and have advanced automatic disc production lines and automated assembly lines. Tianpeng is one of the drafting units of national standards for automatic control devices (GB14536, GB/T22687), and has 6 invention patents and more than 30 utility model patents.

There are three major series of sudden jump thermostats: 10A/16A, 25A, and 60A. According to the diameter of the temperature sensing element bimetallic sheet, they are classified as: 1/2", 3/4", 1" Large series. The temperature range of the thermostat ranges from -32°C to 270°C. The products have obtained CQC, UL, VDE, TUV global four major safety certifications.

Tianpeng sudden jump thermostats have been widely used in various household appliances, printers, including car seat filters, seat heating, etc.

**主要展品 /Products**

温控器、突跳式温控器、KSD系列温控器、限温器

thermostat, snap action thermostat, ksd series thermostat, thermo fuse, thermo cut-off



**佛山市通宝华通控制器有限公司**  
**Foshan Tongbao-Huatong Controls Co., Ltd.**

**W5-5A30**

地址: 广东省佛山市祖庙街道上沙东街43号佛山通宝股份有限公司(上沙街)(528000)

Add: No. 43, Shangsha East Street, Zumiao Street, Foshan City, Guangdong Province

电话 /Tel: 0757-82622433

网址 /Web: <https://www.hsct-fstb.com.cn/>

佛山通宝自1982年起生产专业温控器及提供温控解决方案，2021年成为广州工业投资控股集团旗下企业。40多年来，通宝华通现已发展成为全国最大的专业温控器生产企业及温度控制解决方案供应商，广泛的生产线在提供复杂温度控制解决方面有着显著的优势。我们一直专注于为小家电、冷柜、

空调、汽车、机柜、压缩机和低压电器等行业客户提供优质的产品和服务。

FSTB has produced professional thermostats and provided temperature control solutions since 1982, and became a subsidiary of Guangzhou Industrial Investment Holding Group in 2021. After more than 40 years, under the influence of our innovation and enterprising spirit, FSTB has become the world's leading thermostat manufacturer and the largest domestic thermostat manufacturer, and a global design, engineering and manufacturing company, we have been committed to providing the field of temperature control professional solutions, and is committed to the development of high-efficiency and energy-saving products to contribute to the cause of green, low-carbon and environmental protection.

**主要展品 /Products**

主要生产双金属式温控器、体胀式温控器、压力式温控器、压缩机保护器。旗下生产的“双箭牌”温控器是广东省名牌产品，产品型号齐全在行业内形成了产品质量优良的口碑，我们致力于为顾客提供最佳的温控器解决方案。不断开拓国际市场，产品已远销欧洲，北美，南美，中东，日本，东南亚等国家和地区。通用电气、西门子、惠而浦、松下、日立、施耐德、博世、三星、伊莱克斯、LG、美的等众多知名品牌家电都在使用通宝华通的产品。

We are headquartered in Foshan, China, with 1000 employees, our thermostats and supporting solutions are widely used in fields of home appliances, automobiles, compressors, commercial kitchens, low voltage/electricity, medical equipment, security, cabinets, office/communication equipment, etc, to achieve the function of temperature, current control and thermal protection. We are a high-tech enterprise and a provincial engineering technology research and development center for thermostats.



**佛山市业航电器有限公司**  
**FOSHAN YE HANG ELECTRONIC CO., LTD.**

**E1-1B11**

地址: 广东省佛山市顺德区勒流街道龙眼村西连路52号集龙智造园9栋401(528322)

Add: 4th Floor, Block 9, Jilong Industrial Park, Longyan, Leliu Town, Shunde, Foshan, Guangdong, China

电话 /Tel: 0757-26968215

传真 /Fax: 0757-26968215

网址 /Web: [www.yehangelectronic.com](http://www.yehangelectronic.com)

佛山市业航电器是一家专业生产加湿器、香薰机、空气净化器的企业。本厂成立于2006年。厂房面积5000平方米,通过ISO9001质量管理体系认证。公司现有员工80-100人,其中专业研发人员10人。我们的产品通过了CE, CB, RoHS, FCC, PSE, KC 认证, 其中有15款产品拥有由中国国家知识产权局颁发的外观专利证书。业航欢迎您随时光临。期待与您建立长期的合作关系。

Foshan Ye Hang Electronic Co., Ltd is a professional manufacturer of electrical ultrasonic humidifiers, aroma diffuser and air purifiers. Our factory was established in 2006, located in the biggest market of the electrical appliances-- Shunde, Foshan, Guangdong, occupied area 5000 square meters and verified by ISO9001 quality management system. We have more than 100 employees, including 10 professional R&D staffs. With the powerful R&D department, we develop at least 10 new models to different markets every year according to the different requirements. OEM and ODM orders are welcomed. We have a strict Q.C. team insure the quality from the raw material to the end products. Based on the strict quality control, our products are approved by

CE, CB, RoHS, FCC, PSE, KC standards.

#### 主要展品 / Products

加湿器、香薰机、空气净化器、电动拖把。

Air Humidifier, Aroma Diffuser, Air Purifier, Electric Mop.



「一站式全屋智能」

#### 佛山市云米电器科技有限公司

#### Foshan Viomi Electrical Technology Co., Ltd.

地址：广东省广州市海珠区新港东路 1238 号万胜广场 C 塔 13 层云米科技 (512000)

电话 / Tel: 400-100-2632

网址 / Web: <https://www.viomi.com.cn/>

云米是全球领先的物联网高科技企业 (IoT@Home)，创业仅 4 年于美国纳斯达克成功上市 (NASDAQ:VIOT)。云米致力于构建智能理想的家，为全球用户提供「一站式全屋智能」解决方案：智能家电 + 智能家居 + 软件服务。

云米全屋智能提供 60+ 种智能互联产品，通过 5G+AI+10T 等前沿科技，持续为年轻家庭带来更舒适、健康、安全、可成长的智能生活体验。

We has developed a unique IoT @ Home platform consisting an ecosystem of innovative IoT-enabled smart home products, together with a suite of complementary consumable products and value-added businesses.

This platform provides an attractive entry point into the consumer home, enabling consumers to intelligently interact with a broad portfolio of IoT products in an intuitive and human-like manner to make daily life more convenient, efficient and enjoyable, while allowing us to grow our household user base and capture various additional scenario-driven consumption events in the home environment.

#### 主要展品 / Products

云米全屋智能提供 60+ 种智能互联产品，通过 5G+AI+10T 等前沿科技，持续为年轻家庭带来更舒适、健康、安全、可成长的智能生活体验。

Viomi IoT @ Home has developed 60+ product categories,

contains smart appliances + smart devices,

covering kitchen / living room / bedroom / bathroom / balcony scenarios...



YMD

#### 佛山市展远电子有限公司

#### Foshan City Zhanyuan Electronics Company Limited

地址：广东省佛山市顺德区勒流镇连江东路 14 号 (528322)

Add: No. 14, Lianjiang East Road, Leliu Town, Shunde District, Foshan City, Guangdong Province

电话 / Tel: 0757-63379069

传真 / Fax: 0757-81807890

N1-1F41

E3-3A02

网址 / Web: [www.ymd-zy.com](http://www.ymd-zy.com)

佛山市展远电子有限公司是专业服务于各类型电器开关，拥有多套全自动生产线、高速模内冲床、ENEC 检测设备、UL 检测设备、二次元检测设备等精准检测仪器，确保每一个成品都能得到质量的保障。公司一直坚持“打造开关行业知名品牌，存活 99 年”为愿景，为客户提供高质量的产品、一流的服务水平，满足客户的最高要求。在未来，公司秉着“对内成就员工，对外成就客户”的使命，把行业资源打造和实现可持续发展的供给平台。

Foshan Zhanyuan Electronics Co., Ltd. is a professional service for various types of electrical switches. It has many sets of automatic production lines, high-speed in die punch, ENEC testing equipment, UL testing equipment, secondary element testing equipment and other accurate testing instruments, so as to ensure that each finished product can be guaranteed in quality. The company has always adhered to the vision of "building a well-known brand in the switch industry and surviving for 99 years", providing customers with high-quality products and first-class service level to meet the highest requirements of customers. In the future, adhering to the mission of "achieving employees internally and customers externally", the company will build industry resources into a supply platform for sustainable development.

#### 主要展品 / Products

主要研发、设计、生产各种翘板开关、微动开关、滑动开关、按键开关、电压转换开关、船型开关、拉链开关、防水开关等。产品广泛应用于各种类型的电吹风、卷发器、电烫斗、吸尘器、电煮锅、咖啡机、破壁机、取暖器、晾衣架、洗脚盘等多种家用电器上。

It mainly develops, designs and produces all kinds of rocker switches, micro switches, sliding switches, key switches, voltage transfer switches, ship switches, zipper switches, waterproof switches, etc. The products are widely used in various types of hair dryers, hair curlers, electric irons, vacuum cleaners, electric cookers, coffee machines, wall breakers, heaters, clothes racks, foot washing trays and other household appliances.



#### 佛山市臻运制冷科技有限公司

#### Foshan Zhenyun Refrigeration Technology Co., Ltd.

地址：中国广东省佛山市顺德区勒流街道众涌村众裕路以西 11-3 号之七

电话 / Tel: 13760750583

本公司是一家专业设计制造小型空调产品企业，目前开发的便携式空调，考虑到使用的环境，合理的设计，户外取消了排风管，帐篷使用更方便；户内使用，机身前后设计不超过 235mm，在客厅茶几上、在学生使用的书桌上使用非常方便。造型美观，设计合理，选材优良，制造精细，价格优惠。本产品突出常规设计，符合人体工程学，满足大多数人们的使用习惯，在局部制冷或占空间制冷方面有极大的优势，很好的满足了用户的要求。

#### 主要展品 / Products

便携式空调，适合户外旅游帐篷

W1-1D97

**Zonedesign.**  
INDUSTRIAL DESIGN**佛山市众意工业设计有限公司****E2-2C51-04****Foshan Zhongyi Industrial Design Company Limited**

地址: 广东省佛山市顺德区北滘镇广东工业设计城H栋1楼2楼

Add: The First and Second Floor, Building H, NO.1 North Sanle Road, Beijiao, Shunde,

Foshan, Guangdong

电话 /Tel: 13392255018

网址 /Web: www.zonedesign.com.cn

众意设计 2013 年成立, 秉持“打造世界级中国工业设计品牌”的理想, 先后获评“国家高新技术企业”、“省级工业设计中心”。设计优势: 通过助推企业转型, 以设计创新带动产业创新, 促进工业设计与产业融合, 将设计创新融入品牌培育、产品研发、制造和商业运营, 实现工业设计与制造产业深度融合、联动发展。主要客户: BOSCH、PHILIPS、AEG、INSTANT POT、美的、华裕、苏泊尔、小熊、天喜、卓力等。

Founded in 2013, with the dream of "Building a World Class Chinese Industrial Design Brand", Zonedesign has been awarded "National High and New Technology Enterprise" and "Guangdong Province Industrial Design Center". Advantages: Boost enterprise transformation. Drive industrial innovation through design innovation. Promote industrial design and industrial integration. Integrate design innovation into brand development, product research and development, manufacturing and commercial operations to achieve deep integration and coordinated development of industrial design and manufacturing industries. Main customers: BOSCH, PHILIPS, AEG, INSTANT POT, Midea, Huayu, Supor, Bear, Tianxi, Cuori, etc.

**主要展品 /Products**

厨房家电、两季产品、生活小电、咖啡机、母婴小电、个护产品等。

Kitchen Appliances, Seasonal Appliances, Small Home Appliances, Coffee Makers, Baby and Maternal Appliances etc..

**GLM HEALTH**

歌林美

**佛山顺德歌林美电子产品有限公司****N3-3A28****Shunde Golinmate Electronic Products Co.,LTD**

地址: 广东省佛山市顺德区大良凤翔工业区 18 号华地科技园 (528333)

电话 /Tel: 86-0757-22918880

网址 /Web: golinmate.com

顺德歌林美自主研发的核心技术——纳米级氧分子通过膜材料, 是国家倡导的创新型高科技企业。公司一直致力于纳米级氧分子通过膜材料研究和应用开发, 目前拥有发明专利和实用新型等专利 30 余项。该纳米材料在常温常压下通过氧芯模组分离法 (OCM 法, Oxygen Core Module), 将空气中氮气和氧气进行有效分离。

The core technology independently developed by Shunde Glinmei, nanoscale oxygen molecule passing through membrane material, is an innovative high-tech enterprise advocated by the country. The company has been committed to the research and application development of

nanoscale oxygen molecules through membrane materials, and now has more than 30 patents for invention and utility models. The nanomaterial was separated effectively from nitrogen and Oxygen in the air by OCM method (Oxygen Core Module) at room temperature and pressure.

**主要展品 /Products**

三防功能橱柜: (防虫、防潮、防霉菌) 1、存放名贵药材 (参片、灵芝等), 大米、大豆, 干果、坚果等, 通过物理原理让食材存放于无氧环境下, 让虫卵没有孵育条件, 同时蟑螂或其他成虫进行箱体也会因无氧而死。同时, 食材长期处于合适的湿度和温度下及无氧环境下, 对食材的保鲜、营养成份的保存都有明显的效果。而对于大豆、花生这些易长黄曲霉素的食材, 众所周知黄曲霉素是强致癌物, 而三防功能橱柜的环境有抑制黄曲霉素生产的作用。

Three - proof function kitchen cabinet (ginseng chips, ganoderma lucidum, etc.), rice, soybean, dried fruit, nuts, etc., in the anaerobic environment through the physical principle, so that there is no incubation conditions for insect eggs, and cockroaches.

**佛山万马电子科技有限公司****W1-1B24****Foshan Wanma Electronic Technology Co., LTD**

地址: 佛山市顺德区容桂天富来工业城 5 期 5 座 402

Add: 402, Block 5, Phase 5, Ronggui Tianfulai Industrial City, Shunde District, Foshan City

电话 /Tel: 15986689838

网址 /Web: https://detail.1688.com

佛山万马电子科技有限公司是一家集专业传感器的研发、生产、销售、服务为一体的高科技企业。公司目前拥有 20 多项专利, 通过了 GB/T19001-2016/ISO9001:2015 质量体系认证, 2018 年通过高新技术企业认定, 公司拥有一批经验丰富有创新精神的高科技人才, 以产品质量稳定, 交货快捷和价格优势, 先后与国内外多家著名家电企业建立了战略合作伙伴关系, 产品远销国内外。

Foshan Wanma Electronic Technology Co., Ltd. is a professional sensor research and development, production, sales, service in one of the high-tech enterprises. At present, the company has more than 20 patents, passed the GB/T19001-2016/ISO9001:2015 quality system certification, and passed the recognition and evaluation of high-tech enterprises in 2018. The company has a group of experienced and innovative high-tech talents, with stable product quality, fast delivery and price advantages, It has established strategic partnership with many famous home appliance enterprises at home and abroad, and its products are sold at home and abroad.

**主要展品 /Products**

液位传感器、流量传感器、液位控制器、红外探测传感器、风速感应开关、马达限流模块。

liquid level sensor, flow sensor, liquid level controller, Infrared detection sensor, Wind speed sensing switch, Motor current limiting module.

**佛山御小兔科技有限公司**  
**Foshan Ubunnys Technology Co., Ltd.****W4-4A40**

地址: 广东省佛山市顺德区北滘镇顺江社区陈大滘工业园创业一路1号208室(528311)

Add: Room 208, No. 1, Chuangye 1st., Chendajiao, Shunjiang, Beijiao, Shunde, Foshan,

Guangdong

电话 /Tel: 15810981907

传真 /Fax: 0757-23608802

网址 /Web: <http://www.ubunnys.com/>

作为国内新锐 AI 健康家电品牌, 致力于重新定义健康家电, 用智能手机工艺要求做家电产品, 由健康按摩品类起步, 带动健康小家电升级革新。企业源于上品设计创新集团, 团队核心成员均来自世界百强企业, 基于上品创新设计集团双三百 (300+ 全球设计师 /300+ 产品设计大奖) 的积累与沉淀, 基于团队专业级家电经验, 通过以健康家电为基础, 辅以物联网及 AI 家电整体解决方案, 通过软硬件结合交互, 形成健康科技生态综合体系。

Ubunnys is a purveyor of a smart lifestyle. Through ingenious designs and unmatched service, we offer a wide range of products.

With an emphasis on technology and research and development, we engineer our products with our consumers in mind to ensure a smart and effortless lifestyle for everyone.

**主要展品 /Products**

- 3D 打印颈部按摩枕是针对“低头族”提出的一种颈椎健康专业护理方案, 通过采用 HALS 超高速 3D 打印技术、结合全新自研高性能高分子材料, 实现了按摩产品的升级革新。
- 按摩体验的升级主要是将 3D 打印技术应用到按摩最核心的按摩头上, 通过参数化设计, 使按摩头表面触点更多, 实现比传统按摩头更贴合颈部曲线、更全面按摩的效果。
- 应用 3D 打印技术赋能产品创新, 让科技改变生活, 致力于重新定义健康。

- SHIATSU KNEADING MASSAGE - Ubunnys Neck massager using 3D printing deep-kneading Shiatsu massage nodes helps loosen up your tight neck, back and shoulders. Equipped with 4 sets of massage nodes, this innovative massager work in clockwise and anti-clockwise rotation. With the 2500mah battery, you can use our mini massager for 7 days after one fully charge.
- SORE & TIRED MUSCLES RELIEF - Provides imitation ten-finger massages on your neck, shoulders, upper back, lower back, waist, foot, thighs, calves, legs, feet and arms. 4 levels invisible magnetic buckle design suitable for various neck width.
- ERGONOMIC DESIGN & PORTABLE - Ergonomic U-shaped design fits perfectly behind neck and back and contours your spine and lower back. The travel pillow is made of slow rebound memory foam, soft and comfortable. You can take it anywhere with you and enjoy a deep tissue massage in your home, car, office or anywhere.

**福安市茗振电子有限公司**  
**Fushi mingzhen electronics co., ltd****E3-3A03 3A04**

地址: 福建省宁德市福安市阳头街道阳泉花园路 206 号 (355000)

Add: No.206, Yangquan Garden Road, Yangtou Street, Fu 'an City, Ningde City, Fujian Province

电话 /Tel: 18065089983

传真 /Fax: 0593-6371455

网址 /Web: <http://www.mingzhen.co/>

茗振电子长期致力于舒适好用的按摩器, 保健器具, 美容产品的设计以及研发和销售。企业拥有多项专利以及拥有众多符合国际标准的的专业产品, 目前产品已经有数百款。茗振所研发设计的产品不仅在国内外颇受欢迎, 在长期的发展后还远销欧美, 俄罗斯以及东南亚国家。

Mingzhen Electronics has long been committed to the design, R&D and sales of comfortable massagers, health care appliances and beauty products. The company has many patents and many professional products that meet international standards, and there are hundreds of products at present. The products developed and designed by Mingzhen are not only popular in China, but also exported to Europe, America, Russia and Southeast Asian countries after long-term development.

**主要展品 /Products**

按摩枕 筋膜枪 海盐热敷包 按摩椅 颈椎仪

Massage pillow fascia gun sea salt hot pack massage chair cervical vertebra instrument

**福建赛特新材股份有限公司**  
**Fujian Supertech Advanced Material Co., Ltd.****W2-2B01**

地址: 福建省龙岩市连城工业园 (366208)

Add: Lianguan Industrial Area, Liancheng County, Longyan City, Fujian Province, China

电话 /Tel: 15080313580

传真 /Fax: 0592-6199939

网址 /Web: [www.supertech-vip.com](http://www.supertech-vip.com)

福建赛特新材股份有限公司, A 股上市企业 (股票代码: 688398), 主营真空绝热板 (VIP) 的研产销, 长期致力于为冰箱冷柜、自动贩卖机、冷藏保温箱等产品提供系统化的绝热节能解决方案。

十多年持续专注的科研投入和市场推广, 使得为全球冰箱冷柜等家电用绝热材料领域的知名供应商, 所生产的真空绝热材料在全球冰箱冷柜领域的市场占有率处于行业领先地位。

Fujian Supertech Advanced Material Co., Ltd. was founded on October 23, 2007. Shanghai A-share Listed Company (Stock name: supertech, Stock Code: 688398). We specialize in R&D, manufacture and sales of Vacuum Insulation Panel (VIP). Supertech is the first company starting mass production of VIP in China and devoted to providing the systematic insulation and energy saving solution for manufacturers of fridge, freezer, vending machine, cold chain insulated box etc. With more than 10 years continuous focus on R&D investment and marketing, we effectively promote the new type of high efficiency and energy saving environmental protection material of



vacuum insulation panel in the industrial application. We have achieved good brand awareness of VIP and become a well-known supplier in the field of thermal insulation materials for global home appliance field of fridges and freezers with high market share.

#### 主要展品 /Products

真空绝热板 (VIP), 真空玻璃 (VIG), 烤箱棉, 冷藏保温箱类

Vacuum Insulation Panel (VIP), Vacuum Insulation Glass (VIG), Oven cotton, Cold Chain Insulated BoxType



#### 福州格麟机电技术有限公司

W4-4B42

#### Fuzhou Green Mechanical and Electrical Technology Co.,LTD

地址: 福州闽侯铁岭工业区二期南中路 5 号广正集团厂房内 (350000)

Add: NO.5, South-Middle Road, Minhou economic and technological development zone, Minhou, Fuzhou, China

电话 /Tel: 18605910525

传真 /Fax: 059163106659

网址 /Web: http://www.green-coolings.com

福州格麟机电技术有限公司专注于对冷气机 (蒸发式冷风扇) 及节能技术产品开发与研究。公司集自主研发、生产、销售、服务于一体的科技节能技术企业, 并拥有国内一流的制冷、暖通、结构、模型等专业工程技术人才和强大的国际国内销售团队。格麟以客户为中心, 坚持科技创新为主导的经营理念, 具有完善的品质管理体系, 专心专注, 精益求精, 缔造稳定可靠的高性能高品质产品。格麟全系列技术水平遥遥领先国内同类产品水平。

Fuzhou Green Mechanical and Electrical Technology Co., Ltd majors in research and development of evaporative air cooler and energy-saving technology products. Fuzhou Green have been in the lead in research and development, and in energy-saving technology field. Fuzhou Green Mechanical and Electrical Technology Co., Ltd. specializes in Evaporative Air Cooler, and becomes a professional manufacturer who offers whole solution of cooling to suit your business needs. It brings cool and purified air via natural water evaporation. With big covering area, low energy consumption and available in large open area, it's a good choice for people who concerns about minimizing the cooling cost. With the strength of R&D team and the excellent after-sale services, we can supply the most competitive products with lower price and higher quality. We will do our best to meet your requirements and are sincerely looking forward to having the opportunity of becoming your partner in the near future.

#### 主要展品 /Products

格麟蒸发式冷气机有 GL20Z、GL30Z、GL50/80L、GL100、GL06/07、GL075、GL038、GL05 等系列产品, GL20Z、GL30Z 系列采用工程塑料外壳结构、大风量低噪声轴流风机, GL50/80L 系列采用金属外壳、大风量较高风压离心风机, 适用较大型厂房和商用场所; GL100、GL06/07、GL075、GL038、GL05 属于移动机型适合岗位降温及室内移动降温以及家用场所。

Fuzhou Green Mechanical and Electrical Technology Co., LTD (Founded 2011) are professional manufacturer on water evaporative air cooler, evaporative cooling is very economic way for cool and evaporative air cooler is very suit for hot and dry climate are



#### RUBBER VALVE

#### 福州景腾精工橡塑制品有限公司

E1-1B47

#### Fuzhou Jingteng Seiko Rubber & Plastic Co.,Ltd

地址: 福建省福州市马尾区马尾镇儒江东路 70 号 7# 楼一层西面 103 室 (自贸试验区内) (350015)

Add: SCUD INDUSTRIAL PARK, NO.70 RUJIANG EAST RD, MAWEI DIST, FUZHOU

电话 /Tel: 13905009392

网址 /Web: www.rubbervalue.com

多年来, 我们一直致力于流体控制领域。依托强大的技术储备与开发团队, 我们为客户量身定制解决方案。现有的产品 (如鸭嘴阀、伞形阀、球阀、阀的组件、膜片等) 及服务主要应用于家电、医疗、小型发动机、水处理、食品和包装行业。

Over the years, we have been always committed to the field of flow control. Relying on strong technical reserves and a team of developers, we often provide our clients with customized solutions. Existing products (Such as Duckbill valves, Umbrella valves, Ball valves, Valve components, Diaphragm, etc.) and services mainly for the appliances, medical, small engines, water treatment, food and packaging industries.

#### 主要展品 /Products

伞形阀、鸭嘴阀、综合阀、塑料鸭嘴阀、弹簧球阀、顶冲阀、塑料膜片阀。

Umbrella Valve, Duckbill Valve, Integrated Valve, Spring Plastic Check Valve, Diaphragm Plastic Check Valve.



#### 福州三立电子有限公司

W4-4B25

#### FUZHOU SWELL ELECTRONIC CO., LTD

地址: 福州市闽侯县南屿镇智慧大道 6 号慧博科技园区 4# 楼 (350000)

Add: BLDG.4. NO .6 ZHIHUI AVENUE, NANYU TOWN, FUZHOU, CHINA

电话 /Tel: 0591-87911775

传真 /Fax: 0591-38260283

网址 /Web: www.swell-time.com

福州三立电子有限公司位于福州市闽侯县, 占地面积 7000 多平方米。公司通过 ISO9001、ISO14001、BSCI、SEDEX、WCA 等认证。我们有 10 条生产线在 2 个不同的车间, 并有自己的实验室进行产品测试。同时拥有一支高效、专业的 OEM 项目团队。集 LCD/LED 产品的设计、开发、制造、销售为一体, 具有以下功能: 气压计, 温度计湿度计时钟计时器收音机 RC 时钟, 有线 /RF/Wifi/ 蓝牙无线气象站。

Fuzhou Swell Electronic Co., Ltd., located in Fuzhou city, with coverage more than 7000 square meters. The management and verification are ISO9001 & ISO14001, BSCI, SEDEX and WCA. We have 7 production lines in 2 different workshops and have our own lab for product tests. Integrating the design, development, manufacture and sales of LCD/LED products, with functions: barometer, thermometer, hygrometer, clock, timer, radio, such as RC clock, Wired/RF/Wifi/Bluetooth wireless weather station, grilling thermometer, Stopwatch and newly include infrared thermometer measuring meter detector, wall stud detector, etc.

**主要展品 /Products**

LCD/LED 温湿度计, 气象站, 工业测试工具等。

LCD/LED hygrometer, color weather station, measuring tools etc.

**富乐母南京贸易有限公司  
FROM Nanjing Trade Co.,Ltd****N2-2B38**

地址: 南京市玄武区珠江路 88 号新世界中心 A 座 3910

电话 /Tel: 025-84705008

网址 /Web: www.nj-from.com

富乐母工业株式会社 (FROM SYSTEM DIRECT 中文名称: 富乐母) 是一家集开发、设计、生产和销售为一体的专业做厨余垃圾处理器的公司。研究食物垃圾处理器 40 年。长期以自主品牌为主线, 以卓越的品质, 优质的售后著称, 产品占有率在日本国内市场处于领先地位。2022 年成立富乐母南京贸易有限公司。主营家用、商用、船舶用食物垃圾处理器及处理系统。产品拥有 CQC 国际认证, 在日本获得三十六项认证和专利。

**主要展品 /Products**

富乐母厨余处理器主要分为家用和商用。家用垃圾处理器能够以压倒性的粉碎力处理多种类型的生垃圾。可减轻投入前分拣生垃圾的麻烦, 使您能够舒适地使用。另外, 采用了盖开关运行。同时实现了安全性。业务用厨房垃圾处理器可大幅减少酒店、餐馆等的生垃圾。对卫生对策也有帮助, 是凝聚日本制造的高技术能力的产品。

**赣州禾盈通用零部件有限公司  
Ganzhou Heying Universal Parts Co. Ltd****N4-4B26**

地址: 江西赣州市章贡区沙河工业园金盆山路 12 号 (341100)

Add: Jinpengshan route Shahe Industrial Park 12 Zhanggong Region, Ganzhou City, Jiangxi Province.

电话 /Tel: 0797-8487098

传真 /Fax: 0797-8487398

网址 /Web: www.heyincn.com

禾盈自创立以来一直专注于研发、生产和销售精密塑胶件、塑胶紧固件、标准件、通用零部件以及精密塑胶模具。为客户提供一站服务。

坚持走自主研发的道路, 拥有经验丰富的研发团队、专业的质量保证团队, 我司自主研发产品获得了 18 项发明专利, 50 项外观专利以及 33 项设计专利。此外, 我司自 2015 年起持续获得“国家高新技术企业”的认证。

Heying Has been specializing in R&D, manufacturing and managing with plastic precision parts, plastic fasteners, standard parts, general auto parts and delicate plastic mold design and manufacture. We aim to providing every customer with “one stop” service.

Heying has a professional and elite R&D team, which has gained 18 invention patents, 50 utility patents, and 33 design patents. Moreover, Heying was honored as “HIGH NEW TECHNOLOGY ENTERPRISE” which was acknowledged by the government since year 2015, Taking the great advantages of R&D and manufacture technology, We have been continuously developing new products with wide range and proving customers with quick solutions to the broadest product category.

**主要展品 /Products**

1、门扣 2、阻尼器 3、配线器材 4、脚垫 5、塑胶螺丝 6、铆钉 7、PC 间隔柱 8、六角柱 9、铝旋钮 双色旋钮 10、文具扣 11、塑胶螺母

Door buckle, damper, wiring accessories, foot pad, plastic Screw, plastic rivet, PC spacer column, Hexagonal column, knob Two color knob, Stationery buckle, plastic nut



YarwinSun

**广德亚蕴申橡塑有限公司  
Guangde YarwinSun Rubber & Plastic CO., Ltd.****N1-1B43**

地址: 安徽省宣城市广德市文正路 522 号 (242299)

Add: No. 522, Wenzheng Road, Guangde Economic Development Zone, Guangde County, Xuancheng, Anhui, China

电话 /Tel: 0571-87759503

传真 /Fax: 0571-88750251

网址 /Web: http://www.gd-yarwinsun.com/

广德亚蕴申橡塑有限公司是集橡胶、塑料、五金等产品生产于一体的综合性民营企业, 工厂占地面积 20000 平方米, 拥有员工 200 余人。公司拥有实验室、产品检测部门、体系管理部门、橡胶模压车间、橡胶挤出车间、注塑车间、塑料挤出车间。公司主要产品用于厨电、汽配、灯具、医疗、卫浴等领域。我司拥有独立创新的研发团队、经验丰富的橡塑配方工程师、结构工程师和工艺工程师, 可独立研发各类橡塑制品。

Guangde Yarwinsun Rubber & Plastic Co., Ltd. is a comprehensive private enterprise integrating the production of rubber, plastic, hardware and other products. The factory covers an area of 20,000 square meters and has more than 200 employees. The company has laboratories, product testing departments, system management departments, rubber molding workshops, rubber extrusion workshops, injection molding workshops, and plastic extrusion workshops. The company's main products are used in kitchen appliances, auto parts, lamps, medical, bathroom and other fields. Our company has an independent and innovative R&D team, experienced rubber and plastic formulation engineers, structural engineers and process engineers, and can independently develop various rubber and plastic products.

**主要展品 /Products**

橡胶密封件、缓冲件、垫圈、油封、胶管、防尘套和减震器、橡胶管、橡胶条、手柄等等。

Rubber seals and gaskets, buffers, washers, oil seals, hoses, bellows, shock absorbers, tubes and strips, handles etc.

**Bestherm®****广东爱禾科技有限公司****Guangdong AIHE Technology Co., Ltd.****E1-1C41**

地址: 广东省佛山市顺德区伦教街道薰涌村新薰北一横路 1 号之七 (住所申报) (5380000)  
电话 /Tel: 13201452627

广东爱禾科技有限公司是一家集高端定制、创新研发、智能制造于一体的国际化企业。公司从成立伊始就瞄准了智能环境电器这一细分领域, 从前期引进欧洲技术, 到成立法国全资子公司自主研发创新, 走出了一条国产逆袭之路。如今已是壁挂式暖器欧洲市场领导者并在产品智能化上处于行业领先。源自法国的 Bestherm 百斯腾品牌成为国内全屋智能暖器的头部品牌。

Guangdong AIHE Technology Co., Ltd. is a high-end custom, innovative research and development, intelligent manufacturing in one of the international enterprises. Since its inception, the company has aimed at the smart environment electrical appliances, a subdivision of the field. From the introduction of European technology in the early stage to the establishment of a wholly-owned subsidiary of France to independently research and develop innovation, it has embarked on a path of homegrown counterattack, is now the European market leader in wall-mounted heaters, and in product intelligence in the industry leader. Bestherm bestin brand from France to become the head of the domestic house smart heater brand.

**主要展品 /Products**

广东爱禾科技有限公司主营产品有: 壁挂取暖器, 落地取暖器, 暖风机, 石墨烯取暖器, 远红外取暖器, 落地扇, 金属扇, 循环扇, 智能扇, 无叶风扇, 移动壁炉, 无雾加湿器, 超声波加湿器, 踢脚线, 移动空调, 除湿机等。

Guangdong AIHE Technology Co., Ltd. main products are: wall-mounted heaters, floor heaters, heaters, graphene heaters, far-infrared heaters, floor fans, metal fans, circular fans, intelligent fans, leafless fans, mobile fireplace, non-fog humidifier, ultrasonic humidifier, skirting line, mobile air conditioning, dehumidifier, etc.

**广东奥迪威传感科技股份有限公司****Audiowell Electronics (Guangdong) Co., Ltd.****N4-4A23 4A24 4A25**

地址: 中国 广东 广州市 番禺区 沙头街 银平路 3 街 4 号 (511400)  
Add: NO.4 BLOCK YINPING ROAD, PANYU, GUANGZHOU, GUANGDONG, CHINA  
电话 /Tel: 020-84802041  
传真 /Fax: 020-84665207  
网址 /Web: <http://www.audiowell.com/>

广东奥迪威传感科技股份有限公司成立于 1999 年, 证券简称: 奥迪威 (证券代码: 832491), 是专业从事智能传感器和执行器及相关应用的研究、设计、生产和销售的高新技术企业。作为专业的传感器及执行器厂商, 掌握换能芯片制备、产品结构、智能算法和精密加工技术等, 产品包括测距传感器、流量传感器、压触传感器及执行器、雾化换能器及模组、报警发声器等, 应用于汽车电子、智能仪表、智能家居、安防和消费电子等领域。

Established in 1999, AUDIOWELL is a hightech enterprise specializing in the research, design,

production and sales of intelligent sensors, actuators and related applications. As a professional sensor and actuator manufacturer, our company has mastered the preparation of energy conversion chip, product structure design, intelligent algorithm and precision processing technology, and is committed to becoming the main provider of core components and solutions of the sensing layer and execution layer of the Internet of things.

AUDIOWELL's main products include distance-measuring sensors, flow sensors, pressure touch sensors and actuators, atomization transducers and modules, alarm sounders, etc. they are widely used in the fields of automotive electronics, smart metering, smart home, security systems and consumer electronics. While serving Chinese customers, we have also provided professional products and services for the global customers in many countries and regions.

**主要展品 /Products**

材质识别超声波传感器、空调加湿模组、超声波流量计、防撞传感器、水箱液位模组、纯精油雾化方案、自动加水模组。

300K Ultrasonic Sensor, Collision prevention sensor, Liquid Level Managing Module, Intelligent Atomizing Module, Pure essential oil Atomizing Solution, Ultrasonic Flow Meter Module, Intelligent water filling module.

**Homa**

出口品质 奥马冰箱

**广东奥马冰箱有限公司****Homa Appliances Co., Ltd.****W2-2F31**

地址: 广东省中山市南头镇东福北路 54 号 (528427)  
Add: No.54 North Dongfu Road, Nantou, Zhongshan, Guangdong, 528427, China.  
电话 /Tel: 0760-23136888  
传真 /Fax: 0760-23136888  
网址 /Web: <https://www.homa.cn/>

广东奥马冰箱有限公司成立于 2002 年, 已为全球超过 130 个国家的 2000 多个合作伙伴提供专业的冰箱研发、制造服务。现拥有 11000 名全球员工, 拥有 9 家工厂, 年产能 1500 万台, 是全球最大的冰箱出口制造基地、全球最大的冰箱 ODM/OEM 企业、全球第五大冰箱制造企业、行业公认的全球冰箱竞争力最强的制造企业。截至 2022 年, 奥马冰箱已连续 14 年蝉联全球冰箱出口销量冠军, 连续 15 年蝉联冰箱出口欧洲冠军。

Born as OEM producer 20 years ago, and possibly the only pure OEM global player today, Homa has remained true to its flexible self since its foundation, serving others' needs and caring for their aspirations.

We continue to deliver beautifully crafted, Italian-designed, state-of-the-art engineered cooling appliances for the benefit of our clients' brands, and of their final customers. Building reliable relationship with over 2,000 world-renowned brands, retailers and importers, Homa maintains to be the No.1 Choice of Supplier in Cooling.

**主要展品 /Products**

2021 年, 在第一代“零度保鲜”技术的基础上, 奥马冰箱推出了智控零度超保鲜系列冰箱。在智控零度超保鲜技术下保存的鲜肉即使是冻了七天也能做到红润有光泽、化冻无血水、营养不流失, 无需解冻即可轻松一刀切下。智控零度超保鲜专区采用的是密封空间设计与独立微孔风道送冷, 以 NTC 热感检测技术实时测温, 运用 AI 智能算法以 10 次 / 秒频率连续不间断地控冷计算, 使食材能够达到低温储



鲜的效果, 不会让食材结冰, 鲜肉无需解冻。

2021, on the basis of the first generation of 0°C storage technology, Homa launched the "0°C FRESHNESS CHILLER" technology. Under the technology of "0°C FRESHNESS CHILLER", fresh meat can be ruddy and shiny even after being frozen for a week, without losing blood and nutrients, and can be easily cut off without thawing. The refrigerated area of the refrigerator is equipped with 0°C storage zone, which adopts a sealed space design and an independent microporous air channel for cooling. With real-time temperature measuring NTC thermal detection technology, using AI intelligent algorithm to 10 times per second frequency continuous calculation of cooling, the foods to achieve the effect of low temperature to keep it fresh enough, won't make food freezing, and fresh meat doesn't need to thaw.

Greenway  
博力威

**广东博力威科技股份有限公司  
Greenway Technology Co., LTD.**

**E1-1B42 1B43**

地址: 广东省东莞市东城街道东城科技园同欢路 (523000)

Add: Tonghui Road, Dongcheng Science Park, Dongguan, Guangdong, China

电话 /Tel: 0769-27282088

传真 /Fax: 0769-22290098

网址 /Web: www.greenway-battery.com

博力威 (股票代码: 688345) 是一家以锂电池智能制造为基础的高科技企业, 先后获得《中国锂电池出口前 20 强企业》、《中国电池百强企业》、《广东制造业 500 强》等荣誉。在广东东莞, 博力威布局了东城科技园、同沙工业园、望牛墩三个锂电池生产基地; 在境外, 成立了位于比利时的欧洲子公司以及香港子公司, 同时在丹麦设立了锂电池生产线。

Greenway (stock code: 688345) is a high-tech enterprise based on intelligent manufacturing of lithium batteries. It has been awarded "Top 20 Lithium Battery Export Enterprises in China", "Top 100 Battery Enterprises in China", "Top 500 Manufacturing Enterprises in Guangdong" and so on. Greenway has three lithium battery production bases: Dongcheng Science Park, Tongsha Industrial Park and Wangniudun in Dongguan, Guangdong Province. Overseas, we has set up a European subsidiary in Belgium and a subsidiary in Hong Kong, and set up a lithium battery production line in Denmark.

**主要展品 /Products**

博力威主要为定制化电池设计方案以及组装, 涉及领域主要为两轮车、储能、笔记本电池以及定制化电池, 其中, 定制化电池主要为清洁电器电池 (扫地机、吸尘器以及洗地机)、AGV 电池、无人机遥控器电池、测量仪器电池、电动工具电池以及医疗设备电池等, 我司定制化产品线为大疆、云鲸、飞利浦、追光、浦桑尼克、贝尔斯顿、莱卡、sunking、linak、lupe 等一众龙头公司的品牌供应商。

Our company is mainly engaged in the design and assembly of customized batteries, mainly involving e-bike, e-motorcycle, energy storage, laptop batteries and customized batteries. Among them, customized batteries mainly include batteries for cleaning electrical appliances (sweakers, vacuum cleaners and ground cleaners), AGV batteries, drone remote control batteries, measuring instruments batteries, power tools batteries and medical equipment batteries, etc. Our customized product line is DJ, NARWAL, Philips, speedfox, Proscenic, Bestday, Laica, sunking, linak, lupe and other leading companies brand suppliers.



CHINA TECHNOLOGY WINDOWS

**广东布雷斯斯特电器有限公司**

**N1-1B27**

**Guangdong Brest Electrical Appliances Co., Ltd.**

地址: 广东省中山市黄圃镇大岑工业区成业路 101 号 (528429)

Add: 101# Chengye Road, Dacen Industrial Zone, Huangpu Town, Zhongshan City, Guangdong Province

电话 /Tel: 0757-23279301

网址 /Web: www.brest-china.com

广东布雷斯斯特电器有限公司是一家集研发、生产和销售为一体的现代化企业, 是一家领先的 OEM/ODM 小型家电制造商。

广东布雷斯斯特电器有限公司具有 20 年生产经验, 目前我司的产品已经销往全球各地, 产品包括但不限于单双炉头的电磁炉、电陶炉、光波炉、一电一陶组合炉、嵌入式和多头炉。

BREST ELECTRICAL APPLIANCES CO., LTD turns out to be a new leading OEM/ODM manufacturer of small electronic appliances. It is collection of scientific research, production and sales modernized enterprise.

Brest has 20 years production of experiences, at present, our products have covered but not limit to induction cooker, built-in, infrared cooker, exporting all over the world. Brest has 200 workers and four independent workshops including electronic, injection workshop with six injection machines, glass workshop, and production workshop.

Brest's export volume would keep over one million per year from 2015 to now, we believe we will achieve a new peak in the future.

Our products have been certified by CB, CE, GS, ROHS, SAA, SASO, EMC EMF LVD JQA, PSE, ISO9000:2000 etc. BSCI certificated manufacturer.

Quality is foremost, Customer come first, Credible Service as Brest concept!

Our mission is achievement of customers and brand!

**主要展品 /Products**

单双炉头的电磁炉、电陶炉、光波炉、一电一陶组合炉、嵌入式和多头炉。

INDUCTION COOKER; INFRARED COOKER; COMBINATION INDUCTION+INFRARED COOKER; BUILT-IN INDUCTION/INFRARED COOKER.



**广东程视视觉科技股份有限公司  
CHANCE3D**

**W1-1B30**

地址: 广州市番禺区石北工业路巨大创意产业园 15 栋 C301 (510000)

Add: guangzhou

电话 /Tel: 18565492456

传真 /Fax: 02039939139

广东程视视觉科技股份有限公司, 简称“程视视觉”, 拥有 CG 全流程视频制作团队, 成立于 2012 年, 全员人数 150 人, 主营影视 动漫及商业广告两大板块, 商业广告长期服务于格力、美的、TCL、索菲亚、万家乐、创维等知名品牌。程视视觉一直秉承“始终坚持做制作精良, 价格公道的影视动漫内容”的理念,



为客户提供国际化影视制作服务,与客户携手成长。

We have a CG full-process video production team, established in 2012, with 150 employees, mainly engaged in film and animation and commercial advertising two sections, commercial advertising long-term service in GREE, Midea, TCL, Sofia, Wanjia, Skyworth and other well-known brands. Chengvision has been adhering to the concept of "always insist on doing well-produced and fairly priced film and animation content", providing international video production services for customers and growing hand in hand with them.

#### 主要展品 /Products

CG 三维视频制作、TVC 拍摄、裸眼 3D、数字虚拟人  
CG TVC



#### 广东德尔玛科技股份有限公司

#### Guangdong Deerma Technology Co., Ltd.

E2-2F41

地址: 广东省佛山市顺德区北滘镇马龙村委会龙汇路 4 号之一 (528311)

Add: No. 4, Longhui Road, Malong village committee, Beijiao Town, Shunde District, Foshan City

电话 /Tel: 0757-29892680

传真 /Fax: 0757-23618681

网址 /Web: <http://www.deerma.com/zh>

德尔玛, 创立于 2011 年的创新电器品牌, 专注于环境加湿、吸尘清洁、生活小家电、厨房小家电等品类产品研发, 全产业链直控和精准选品, 生产出设计好、品质好和高性价比的创新小家电。

德尔玛拥有年轻且富有经验的管理团队, 强大的线上运营能力, 全面布局海外, 开启全球化发展战略, 德尔玛加湿器、杆式吸尘器等产品已经成为行业标杆。

Deerma, an innovative electrical appliance brand founded in 2011, focuses on the research, production and marketing of environmental humidification, dust collection and cleaning, small household appliances, kitchen appliances and other products, direct control of the whole industry chain and accurate selection, and produces innovative small household appliances with good design, good quality and high cost performance.

Deerma has a young and experienced management team, strong online operation ability, comprehensive overseas layout and started the global development strategy. Deerma humidifier, rod vacuum cleaner and other products have become industry benchmarks.

#### 主要展品 /Products

加湿环境类: 加湿器、除湿机、喷香机

吸尘清洁类: 吸尘器、除螨仪、蒸汽拖把、喷水拖把

厨房电动类: 绞肉机、破壁机、果汁机、料理机、搅拌机

厨房电热类: 早餐机、电热水壶、空气炸锅、电热水杯、三明治机、手冲壶、多士炉、电烤箱、电煎锅

家居生活类: 挂烫机、电风扇、杀菌灯、毛球修剪器、干手吹风机、烘鞋器、电暖器

Humidifying Category: Humidifier, Dehumidifier, Incense Dispenser

Vacuum Cleaning Category: Vacuum Cleaner, Mite Remover, Steam Mop, Water Mop

Kitchen Electric Category: Meat Grinder, Blender, Juicer, Food Processor, Stirrer

Kitchen Electric Heating Category: Breakfast Maker, Electric Kettle, Air Frying Pan, Electric

Heating Cup, Sandwich Maker, Handheld Drip Kettle, Toaster, Electric Oven, Electric Frying Pan  
Home Life Category: Portable Steamer, Electric Fan, Germicidal Lamp, Lint Remover, Hand  
Dryer, Shoes Dryer, Electric Heater

## USATA 御尚堂®

### 广东德琪电器实业有限公司

### Guangdong Deqi Electrical Appliance Co., Ltd.

N1-1B10

地址: 广东省中山市小榄镇工业大道中 45 号 (528415)

Add: Building 7 & 3/F., Building 8, No.45 Middle of Industry Avenue, Xiaolan Town, Zhongshan,  
Guangdong, China

电话 /Tel: 13531873127

传真 /Fax: 0760-22625777

网址 /Web: [www.ideqi.com](http://www.ideqi.com)

广东德琪电器实业有限公司始于 2004 年, 目前工厂面积 23000 平方, 员工 350 人, 是一家集设计、研发、生产、销售、服务为一体的多元化企业。国家高新企业, 拥有 ITS 授权目击实验室, 顶尖的技术水平、超强的研发团队; ETL、GS、CE、CB、3C 等各项国内外认证及 100 多项专利; 德琪电器与众多国内外知名品牌成为长期战略合作伙伴, 业务范围遍及全球, 德琪电器是您值得信赖的合作伙伴。

Guangdong DEQI Electrical Appliance Co., Ltd. Locates at Zhongshan, Guangdong,

China. It was founded in 2015. It is one of leading manufacturer with an integrating

R&D ability, strong injection facilities, high-efficiency assembly power and good customer service.

We have been successfully exporting household appliances to Europe, America, Australia, Middle East and Asia Countries.

Currently, DEQI has over 25,000 square meter production base and about 250 employee. Our annual production capacity is over 4 million pieces of small home products including electric glass kettle, tea maker, electric pressure cooker, multi cooker etc. with 5 production lines & 2 assistant lines.

DEQI enjoys a good reputation for its quality products and outstanding performance in China. We have acquired ISO9001:2015, GS, CE, CB, SAA & ETL Certificates, strictly observed "6S" and fully optimized utilization of ERP system as well as good customer service.

#### 主要展品 /Products

电压力锅、电饭锅、电炖锅、电磁炉、电热水壶、燃气炉具、榨汁机、泡奶机、豆浆机、消毒柜、小家电及其配件。

electric glass kettle, Tea maker, Electric pressure cooker, Grill, Multi cooker, Ice cream maker.

德通电线  
DETONG WIRE

广东德通电线有限公司

Guangdong Detong Electric Wire &amp; Cable Co., Ltd.

地址: 江门市高新区光明一路沙津横工业园 1 栋首层 (529000)

电话 /Tel: 0750-3694572

传真 /Fax: 0750-3694572

网址 /Web: www.gddtcable.com

W3-3H75

广东德通电线有限公司成立于 2017 年,有自建厂房 10000 平方米。致力为客户提供优质的电子线、插头电源线、灯饰开关电源线、连接线、防水插等,并专注于开发新式美观的插头。已通过 ISO9001 管理体系认证,中国 CCC、德国 VDE、美国 UL、欧盟 CE、欧盟 ENEC、澳洲 SAA、日本 PSE、韩国 KC 等多国安规认证,均符合欧盟 REACH,美国加州 65 环保要求。为成为世界级优质电源线供应商的目标奋斗。

Guangdong Detong Electric Wire Co., Ltd. professional committed to the Power Cord, industrial cable, Electrical Wires and Electrical Wire Color Textile Cable. We have the ability to provide you with the best quality products and services. We have a self built factory in Jiangmen, China, with a construction area of 10000 square meter and has 100 staff. We have got many approvals, such as China CCC, UL(US) and CUL(Canada), German VDE, Europe CE, Australia SAA and ISO9001:2015. All products in Detong can pass REACH and US California 65 test.

**主要展品 /Products**

电子线、插头电源线、灯饰开关电源线、连接线、防水插等,并专注于开发新式美观的插头。  
electric wire, power cord.



传递美德 好东家

广东东佳实业有限公司

Guangdong Dongjia Industrial Co., Ltd

地址: 广东潮安新安大道与龙华路交界 (515644)

电话 /Tel: 0768-5628555

传真 /Fax: 0768-6676328

网址 /Web: www.gddongjia.com

N1-1A15 1A16

广东东佳实业有限公司,地处享有“不锈钢王国”美称的广东潮州彩塘镇。

公司拥有花园式现代化厂房、先进生产设备流水线,具备一批经验丰富的强有力管理和技术队伍,是一家集研发、制造、销售、服务一体化的不锈钢厨具企业。连年获得“守合同重信用企业”和“优秀民营企业”等荣誉称号。公司通过 ISO9001 质量体系认证,产品被轻工部授予“质量、服务、信誉 AAA 品牌”。

Guangdong Dongjia Industrial Co., Ltd is located in Caitang, Chaozhou  
Our company possesses modern garden workshop, covering an area of 30,000 square meters, which is a famous brand industry company specializing in stainless steel products. Our company has a batch of management group and technicians with research & development, design, production and efficient service and a set of advanced manufacturing equipment and production

line, which is a promising enterprise with a certain scale integrated with research & development, production, sales and service. We have been thought highly by reason of the management idea of “Honest Management, Efficient Management, Excellent Service”. Our company has passed ISO9001 Quality System Certificate and has been selected as “Abide by Contract, Honor Credit Enterprise” and “Excellent Private Enterprise” etc honorary titles.

**主要展品 /Products**

不锈钢蒸锅、汤锅、奶锅、火锅、炒锅、蒸格等不锈钢厨具及拉伸件等。



广东多乐信电器有限公司

DOROSIN

地址: 广州市荔湾区花地大道中 228 号奔富广场 2F (510370)

Add: 2F, Benfu Plaza, No. 228, Huadi Avenue Middle, Liwan District, Guangzhou

电话 /Tel: 020-89637122

传真 /Fax: 020-89637122

网址 /Web: http://www.dorosin-air.com/

W2-2F71

多乐信深耕环境控湿领域 18 年,在广州、杭州、佛山拥有三大产业研发基地。自主设计生产适配不同场景的除湿、加湿、移动冷气设备,配套优质售后服务,竭力为全球客户提供环境温度湿度调控的整体垂直解决方案,已入选制造业 500 强企业,参与制定《除湿机行业标准》,发展成为「专精特新」企业、高新技术企业及广东省守合同重信用企业,备受行业内外的认可。

DOROSIN has been deeply engaged in the field of environmental humidity control for 18 years, and has three major industrial R&D bases in Guangzhou, Hangzhou and Foshan. We have independently designed and produced dehumidification, humidification and mobile air conditioning equipment that are suitable for different scenarios, supported by high-quality after-sales services, and strived to provide global customers with overall vertical solutions for environmental temperature and humidity control. We have been selected as one of the top 500 enterprises in the manufacturing industry, participated in the formulation of the Dehumidifier Industry Standard, and developed into a “specialized and special” enterprise, a high-tech enterprise, and a trustworthy enterprise in Guangdong Province, which has been recognized both inside and outside the industry.

**主要展品 /Products**

除湿机: ER-660E、ER-630E、ER-620E

移动冷气机: DAKC-18、DAKC-35A、DAKC-65、DAKC-27B

Dehumidifier: ER-660E、ER-630E、ER-620E

Mobile air conditioner: DAKC-18、DAKC-35A、DAKC-65、DAKC-27B



## 广东梵吉尼科技有限公司

W4-4B55 4B56

地址: 广东省佛山市顺德区大良街道德和社区国泰南路3号保利商贸中心1栋8层807单元之二  
电话 /Tel: 13915802727

FUNGENE 梵吉尼, 中国新兴科技电器品牌, 诞生于 2015 年, FUNGENE 名字由“FUN (有趣) + GENE (基因)”组合而成, “有趣的基因”作为品牌的精神内核, 驱动着 梵吉尼不断突破创新和美学的界限, 创造更具生命力的产品。

FUNGENE 梵吉尼秉承“美学、科技、工艺”的核心价值, 以“让空间更智慧, 让生活更优雅”为使命, 致力于创造融合科技创新与品质工艺的科技电器, 以艺术美学的方式呈现给消费者

FUNGENE, a Chinese emerging technology electrical brand, was born in 2015, the name FUNGENE is a combination of "FUN + GENE", "funny gene" as the brand's spiritual core, driving FUNGENE to constantly break the boundaries of innovation and aesthetics, creating more vital products. The "funny gene", as the brand's spiritual core, drives FUNGENE to push the boundaries of innovation and aesthetics to create more life-affirming products.

FUNGENE adheres to the core values of "aesthetics, technology and craftsmanship", with the mission of "making space smarter and life more elegant", and is committed to creating technological appliances that integrate technological innovation and quality craftsmanship, and presenting them to consumers in an artistic and aesthetic way, giving life a subversive look. It is dedicated to creating technological appliances that combine technological innovation and quality craftsmanship, and presenting them to consumers in an artistic and aesthetic way

### 主要展品 /Products

智能洗手器 H5 系列  
智能香氛机 A8 系列  
智能香氛机 S5 系列

H5 Automatic Soap Dispenser  
A8 AROMA DIFFUSER  
S5 AROMA DIFFUSER

## Galanz 格兰仕

### 广东格兰仕集团有限公司

N4-4C51

地址: 广东省佛山市顺德区容桂大道南 25 号格兰仕集团 (528305)  
电话 /Tel: 0757-28886389  
传真 /Fax: 0757-28889628  
网址 /Web: <https://www.galanz.com.cn/>

格兰仕集团是一家国际化综合性健康家电和智能家居解决方案提供商, 是中国家电业具有广泛国际影响力的龙头企业之一。格兰仕创业于 1978 年, 一直专注在制造业创新发展, 与时俱进擦亮“中国制造”金字招牌。自 2011 年起发布的中国品牌价值指数 SM (C-BPI®) 排名中, 格兰仕连年保持微波炉行业品牌力第一名。2021 年 5 月, 格兰仕成功要约收购惠而浦 (中国) 股份有限公司 (股票简称: 惠而浦, 证券代码: 600983)。

Based in Guangdong China and founded on 28 September 1978, Galanz Group is a comprehensive white goods enterprise which is among the first group of Chinese home appliance

companies that "went outside", going global in the great labor division and cooperation under economic globalization.

Along with the development of China's reform and opening up, Galanz Group has focused on manufacturing for 40 years. Oriented around the vision "Centennial Enterprise, Global Brand", Galanz keeps its foothold in Guangdong China and develops to go global. From a leading textile company to a world-leading microwave oven manufacturer, and then to a comprehensive, leading white goods group, Galanz has always been a business card for Chinese manufacturing in the international market.

### 主要展品 /Products

微波炉、电烤箱、空调、冰箱、洗衣机、洗碗机。

Microwave, electric oven, air conditioner, refrigerator, washing machine, dishwasher.



股票代码: 832018

### 广东固特科技有限公司

W1-1B42

地址: 广东省梅州市蕉岭县蕉城镇湖谷村固特科技园 11 栋 (514100)  
电话 /Tel: 0753-7892666  
传真 /Fax: 0753-7892666

广东固特科技有限公司专业从事家电厨电、医美个护、清洗清洁、萃取混匀、金属加工等领域的超声波换能器、换能器组件、超声模组的设计开发、生产制造机超声技术应用解决方案的提供。公司协同利用固特集团的技术资源、成为超声应用研发中心, 目前已开发 40 余款适用于超声清洗领域的超声波换能器、30 余款适用于小家电、水槽、洗碗机、美容、医疗领域超声组件, 储备了 20 余套超声技术应用解决方案。

### 主要展品 /Products

超声波换能器、超声组件、超声波清洗技术方案服务。



### 广东哈士奇制冷科技股份有限公司 HCK Refrigeration Tech., Inc

W5-5E51

地址: 广东省佛山市顺德区均安镇畅兴工业园盈安三路一号 (528329)  
Add: 160 East Tasman Dr. Suite 105 San Jose CA 95134  
电话 /Tel: 0757-28093351  
传真 /Fax: 0757-28093351  
网址 /Web: [www.hckfridge.com.cn](http://www.hckfridge.com.cn)

哈士奇创始人 Geo Thomasson 以雪橇犬哈士奇为品牌命名, 以此纪念创业时期陪在身边的雪橇犬。

哈士奇冰吧以高颜值著称, 行业明星网红品牌, 各大电视剧电影综艺节目都有哈士奇冰吧参与录制。

HCK was originally set up by Geoff Thomasson in Finland Y1971, designing and manufacturing



commercial refrigerator.

HCK Refrigeration Tech. was public listed in Y2019 and HCK refrigerators have been supplied to 56 countries across the world.

We are proud to work with the world's greatest brands like Coca-Cola, Budweiser, Monster, Electrolux, etc. Our refrigerators are proudly sold in world's largest retailers, including Costco, Walmart, Carrefour, Metro, etc. Our smart vending fridge is in strategic cooperation with Alibaba's, JD.com's IOT project.

#### 主要展品 /Products

联名款冰吧, 智能售货机, TLCD 智能冰吧, 车载冰箱, 静音睡房冰箱, 圆弧红酒柜, 嵌入式红酒柜, 复古冰箱, 冰吧, 美妆冰箱。

co-branding refrigerator, intelligent vending refrigerator, transparent LCD refrigerator, portable refrigerator for car, noiseless refrigerator, curved wine cooler, built-in wine cooler, retro refrigerator, beverage refrigerator, cosmetic refrigerator.

## SGH 海客堡

广东海客堡环境科技有限公司

N3-3D91

GUANGDONG SGH ENVIRONMENTAL TECHNOLOGY CO., LTD.

地址: 容桂街道容边居委会天河工业区新有路 2 号三层之一 (528306)

Add: www.leeyoroto.com

电话 /Tel: 13143194941

传真 /Fax: 0757-29378228

网址 /Web: www.sgh-air.com

我公司成立于 2014 年, 坐落在广东顺德, 是一家专业空气治理设备供应商, 致力于为客户提供空气净化、加湿、消毒解决方案, 涉及家用和商用多个领域。我们先后在德国、中国、越南等地扩建研发生产基地, 目前服务品牌已超 100 家, 产品畅销全国各地, 出口覆盖欧洲、北美、日韩、东南亚等重要市场。我们拥有 90 多项专利, 并获得“高新技术企业”、“专精特新企业”、“瞪羚企业”、“细分行业龙头”等多项荣誉资质。

Guangdong SGH Environmental Technology Co., Ltd. was established in 2014, located in the "Capital of Home Appliances in China" - Guangdong Shunde, we are a professional air treatment equipment supplier and committed to provide efficient and energy-saving full-range air purification, humidification, and disinfection solutions, involving multiple fields such as living room, bedroom, office, and vehicle. With our forward-looking and leading products in the industry, we have successively expanded research and development production bases in Germany, China, Vietnam, and other places to enhance industrial energy supply, we are rapidly growing into the leader of the air treatment industry. Currently, we have served more than 100 brand merchants, and the products are sold well throughout the country. The export business covers important markets such as Europe, North America, Japan, South Korea, and Southeast Asia, and is deeply recognized by customers and the industry.

#### 主要展品 /Products

空气净化器, 空气消毒机, 空气加湿器。

Air purifier, Air disinfectant, Humidifier.



海清新  
HIKINS

广东海清新环保科技有限公司深圳分公司

E1-1E01

Hikins

地址: 深圳市宝安区石岩街道塘头社区松白路中运泰科技工业厂区综合楼 9 栋六层

电话 /Tel: 13603024381

注册地位于深圳市宝安区石岩街道塘头社区松白路中运泰科技工业厂区综合楼 9 栋六层。经营范围包括一般经营项目是: 空气净化器、电器产品、水处理设备、模具、扫地机器人、智能控制器、电子产品、电子元器件、电子按摩器, 美容美妆及皮肤护理仪器的销售、研发; ; 各种机械电子器具及其控制器的软硬件设计、开发、技术服务及销售; 水处理设备的技术咨询与维修、技术开发及技术转让; 网络科技开发 (不含互联网上网服务)。

#### 主要展品 /Products

主要经营洗地机和扫地机器人, 目前在售款为海清新无线智能洗地机 P8, 集扫拖洗一体, 无风机设计, 高效清洁。



广东合胜集成电气有限公司

N3-3D76

Guangdong Hesheng Integrated Electric Co., Ltd

地址: 中山市黄圃镇魁中路 6 号厂房二

电话 /Tel: 0760-22678035

广东合胜集成电气有限公司于 2021 年 6 月创立于伟人故里中山市, 是集设计、开发、生产于一体的大型集成厨电企业。专业研发、制造集成灶、集成智能水槽、蒸烤箱等厨房电器产品。拥有同行领先的工艺技术, 是国内外专注于服务制造集成厨电的厂家之一。自成立以来, 开发了 30 多款有竞争力的产品, 获得多项技术专利。产品填补了多项国内空白, 是国内一、二线品牌的重要供应商。

#### 主要展品 /Products

A22 集成灶将吸油烟机、燃气灶、蒸箱、烤箱, 消毒柜等功能完美的融合为一体, 具有独特的组合式和高效的吸油烟效果, 实现各项功能最大化使用效率, 全自动地智能化控制, 真正实现人们追求绿色环保型高档厨房电器产品的要求。



广东鸿德电器有限公司

E3-3B48

Guangdong Hongde Electrical Co., Ltd.

地址: 广东省东莞市凤岗镇雁田村长石路京东智谷工业园 15 栋 1101 (523703)

Add: 1101, Building 15, Jingdong Zhigu Industry Zone, Changshi Road,

Yantian, Fenggang, Dongguan, Guangdong, China 523703

电话 /Tel: 076987777129

网址 /Web: www.hdelectrical.cn



广东鸿德电器位于东莞市凤岗镇雁田村长石路京东智谷工业园, 拥有专业研发团队推出高速吹风机、以及海外博士自主研发的护发精油; 鸿德追求产品精益求精, 让用户以普及的价格享受完美的干发护发体验。

Guangdong Hongde Electrical Co., Ltd is located in Jingdong Zhigu Industrial Park, Changshi Road, Yantian Village, Fenggang Town, Dongguan, Guangdong, China  
We have professional R&D team to R&D high-speed hair dryers and hair care oils independently developed by overseas doctors;  
Hongde pursues excellence product, provide perfect dry hair care experience at a popular price.

#### 主要展品 /Products

- 1.11 万转 / 分的无刷马达, 超快速干发;
  - 2.2 亿负离子, 秀发柔顺光泽;
  3. 智能 NTC 温控避免高温损伤;
  4. 符合优质生活的低噪音设计;
  5. 九种吹风模式, 满足不同发质需求;
  6. 全铝合金风筒设计, 引领品质美学;
  7. 多重安全保护, 只为您的安心使用;
  8. 可搭配独家研发精油, 打造完美秀发;
1. 110,000 RPM brushless motor, super fast dry hair;
  2. 200 million negative ions for smooth and glossy hair;
  3. Intelligent NTC temperature control to avoid high temperature damage;
  4. Low noise design in line with quality life;
  5. Nine blowing modes to meet the needs of different hair types;
  6. All aluminum alloy air duct design, leading quality aesthetics;
  7. Multiple security protection, only for your peace of mind;
  8. With exclusive research and development essential oil, create perfect hair;



#### 广东鸿智智能科技股份有限公司 **N3-3D86** Guangdong Hallsmart Intelligence Technology Corporation limited

地址: 广东省湛江市坡头区官渡镇广湛路高速路口西 (524051)  
Add: West Expressway Exit, Guangzhou-Zhanjiang Highway, Guandu Town,  
Zhanjiang, Guangdong, China  
电话 /Tel: 86-759-3836035  
传真 /Fax: 86-759-3719603  
网址 /Web: www.hallsmart.com.cn

我们是一家面向国内外市场, 集研、技、工、贸于一体的现代智能电器制造公司, 建有多条智能化生产线, 主要产品有电饭煲、电压力煲、慢炖锅、空气炸锅、智能电饭煲、烤盘、三明治机等全系列智能小家电。以“智造家电精品 尊享优质生活”为公司使命, 为顾客从研发、生产到销售提供高品质的产品及服务。我们以品质和技术创新为核心竞争力, 致力开发基于未来移动互联网技术的智能、节能、健康家电产品和自动化信息化的智能制造装备。

Hallsmart set up in 1999, is a professional high-tech manufacturer of small home appliances, integrating technology, industry and trade. With the mission to "make smart home appliances, enjoy quality life", Hallsmart provides customers with high-quality products and services by virtue

of its whole value chain covering R&D, production and sales.

It has about 600 employees, 13 assembly lines. Its products include various series, covering electric rice cooker, multi-function cooker, pressure cooker, slow cooker, air fryer, electrical grill, sandwich makers etc.

Beside offering professional export OEM&ODM services, Hallsmart owns independent brands "Hallsmart " and "I cook" in domestic market, which are sold both online and offline.

#### 主要展品 /Products

广东鸿智智能科技股份有限公司主要产品有电饭煲、电压力煲、慢炖锅、空气炸锅、智能电饭煲、烤盘、三明治机等全系列智能厨房小家电。我们的产品以品质和技术创新为核心竞争力, 结合智能、节能和健康家电的概念, 为顾客带来全新的智能精致家电体验。

Our main products are rice cookers, electric pressure cookers, slow cookers, air fryers, multi cookers, grills, sandwich makers and other smart kitchen small appliances. Our products with focus on quality and technological innovation, combined with the concept of smart appliances, energy saving and health home appliances, to bring customers a new intelligent home appliance experience.



#### 广东华九新材料科技有限公司 **W3-3A31** Guangdong Huajiu New Material Technology Co., Ltd.

地址: 东莞市厚街镇溪中路 5 号 2 号工业园 (523000)  
Add: No. 5 Xizhong Road, Houjie Town, Dongguan City, No. 2 Industrial Park  
电话 /Tel: 0769-89762727  
传真 /Fax: 0769-22361156  
网址 /Web: www.cncitie.com

华九集团总部成立于 2008 年 8 月, 位于江西赣州, 占地近 120 亩, 职工 450 人, 是中高性能钕铁硼永磁材料 (“十三五” 战略新材料) 核心生产加工企业和赣州市稀土行业龙头企业。是中国重要的高性能铁钕永磁材料研发、生产及销售高新技术企业。公司已通过 ISO9001 质量管理体系认证及 ISO14001 环境管理体系认证, 已拥有包含审批在内的共 29 项专利, 其中 7 项发明专利, 22 项实用新型专利。

Located in Ganzhou, Jiangxi Province, covering an area of nearly 120 mu, with 450 employees, the headquarters of Huajiu Group was established in August 2008. It is the core production and processing enterprise of high performance NdFeB magnetically hard material ("13th Five-Year Plan" strategic new material) and the leading enterprise of rare earth industry in Ganzhou City. It is an important high-tech enterprise in China that develops, produces and sells high performance magnetically hard material. The company has passed ISO9001 quality management system certification and ISO14001 environmental management system certification, has a total of 29 patents, including 7 invention patents, 22 utility model patents.

#### 主要展品 /Products

各种高强度磁铁  
Various High Strength Magnets



### 广东华声电器实业有限公司

W3-3C68

地址: 广东省佛山市顺德区容桂华口昌宝东路 13 号 (528306)

电话 /Tel: 0757-26680014

传真 /Fax: 0757-26680014

网址 /Web: <http://www.wasung.com/>

公司成立于 1997 年, 是国内新型节能环保家电配线组件的企业, 专业生产橡胶连接线、塑料连接线、电源线、电子线、插头、连接器等, 年销售额达 15 亿元, 是国内的低压橡胶软线和空调连接线制造商, 拥有子公司扬州华声电子实业有限公司、广东华声电缆有限公司等, 与格力、美的、海尔、奥克斯、海信、TCL、长虹、华凌、志高、松下、三星、惠而浦等品牌企业建立了长期合作关系。

#### 主要展品 /Products

橡胶线, 橡胶电源线, PVC 插头线, 室内外连接线, 电子线。



### 广东惠利普智能科技股份有限公司

W3-3B43 3B44

Guangdong Huilipu Intelligent Technology Co., Ltd

地址: 广东省中山市火炬开发区步云路 1 号之一 (528437)

Add: Guangdong Huilipu Intelligent Technology Co., Ltd

电话 /Tel: 0760-88918908

传真 /Fax: 0760-88918908

网址 /Web: <https://www.huilipu.com/>

广东惠利普智能科技股份有限公司, 成立于 1992 年, 是一家专业从事直流无刷电机、步进电机、直流同步电机、直流风机与传动组件的高科技企业。公司下设一个技术研究院, 拥有经验丰富的电机设计、电控方案、自动化设备技术团队及进口高精加工及检测设备。公司下设五个子公司、五个生产基地, 产品广泛应用于家电、智能家居、精密仪器、汽车、通信设备等领域。中山、合肥两地厂房面积近 8W 平方。

Since our company's establishment in 1992, Huilipu Technologies has been committed to applying our technological know-how and innovative strength to design and manufacture Stepper Motor, Brushless DC Motor, DC Axial fan, Blower Fan, and motor stator rotor stamping mould. Huilipu Technologies, headquarters located in Zhongshan, has a research institute, two wholly-owned subsidiaries, four production sites and five associated companies. Our products and solutions support a wide range of applications in industries including home appliances, smart home systems, precision instruments, automotive and telecommunication equipment.

#### 主要展品 /Products

直流无刷电机、步进电机、直流同步电机、直流风机、高精定转子模具与运动组件。

Our main products include Stepper Motor, Brushless DC Motor, DC Axial fan, Blower Fan, motor drive assembly and motor stator rotor stamping mould.

### 建中王®

Henry Wang

### 广东建中王电器有限公司

N1-1A33 1A34

HENRY WANG TRAVEL MUG MANUFACTORY CO.,LTD

地址: 广东省佛山市南海盐步联安大道 53 号 (528247)

电话 /Tel: 0757-85518201

传真 /Fax: 0757-85518200

公司成立于 2003 年 7 月 2 日, 植根制造业之都佛山的生产型企业, 专注便携式电动榨汁杯、搅拌杯的设计与研发生产, 是国内为数不多的具备独立设计和稳定质量的 ODM 电动杯制造商。

我司拥有众多独立自主专利、先进的大型生产设备、稳定的生产能力, 产品矩阵丰富。近年来, 我司在国内发起便携式榨汁杯、搅拌杯潮流, 先后与国际大型品牌商合作, 产品多年销往欧美、东南亚等热门市场。我司的使命是持续提升产品品质和探索市场前景。

#### 主要展品 /Products

搅拌杯, 榨汁杯



### 广东捷容科技有限公司

W3-3A22

Guangdong Jierong Technology Co., Ltd

地址: 东莞市南城区建设路 16 号南城科技园

电话 /Tel: 13790189114

捷容科技始终坚持研发高性能、高质量和高可靠性的超级电容产品, 包括模组, 为客户提供全方位的解决方案, 涉足国网、民用、军用等多个行业与领域, 捷容科技秉承着诚信、务实、创新的企业精神, 力争将公司打造成专业的国家级高新技术品牌企业。

Jierong Technology always adheres to the research and development of high-performance, high-quality, and highly reliable supercapacitor products, including modules, to provide customers with comprehensive solutions, involving multiple industries and fields such as national power grid, civil, military, etc. Jierong Technology adheres to the corporate spirit of integrity, pragmatism, and innovation, striving to build the company into a professional national high-tech brand enterprise.

#### 主要展品 /Products

超级电容、安规电容、薄膜电容

Supercapacitor



**广东金力智能传动技术股份有限公司**  
**Guangdong Kingly Gear CO.,LTD.**

**E1-1B03 1B04**

地址: 广东省惠州市惠东县大岭镇金立智能科技园 (516300)

电话 /Tel: 18144497670

网址 /Web: <http://www.kinglymotor.com/>

广东金力智能传动技术股份有限公司是集微型精密减速器、微型电机、智能控制器于一体的超微智能机电驱动模组方案提供商;目前国内一家同时规模化生产直流电机和减速箱的国家高新技术企业。产品广泛应用于人工智能、机器人、5G 智慧城市、物联网、新能源汽车、智能家居、3C 消费等领域。总部设在广东惠州,拥有惠州惠阳、惠州惠东两处大型生产基地,具全国最大滚齿车间之一、引进大量进口生产及检测设备、超 70 条自动化产线。

KINGLY INTELLIGENT. is a high-tech enterprise engaged in researching and producing all kinds of precise gear motor and controller. Offering core solution to the intelligent application sector. We have received title of national high-tech enterprises. It owns world-renowned enterprise service experience. We have many inventions and utility model patents, many copyrights of motor control software, A large team composed of high-precision gear and micro-motor international elite R & D provides professional custom services for customers. More than 100 professional engineers. We have a large number of production equipment, test equipment, gear processing equipment imported from Japan and Switzerland. All equipment are used Swiss imports Wahli Hobbing Machine, which can precisely control gear accuracy of small modulus. The company owning 70 full automatic assembly production lines. Its production manufacturing level and the cost control are all in the leading position of the nation.

**主要展品 /Products**

直流电机 / 直流无刷电机 / 传动模组 / 微型齿轮 / 减速箱

DC Gear Motor/DC Motor/DC Brushless Motor/DC Planetary Gear Motor



**广东凯华电器股份有限公司**  
**GUANGDONG KAIHUA ELECTRIC APPLIANCE CO.,LTD.**

**N4-4B37**

地址: 佛山市顺德区勒流镇上涌工业区 (528300)

Add: SHANGCHONG DISTRICT, LELIU, SHUNDE, FOSHAN, GUANGDONG, CHINA

电话 /Tel: 0757-25522333

传真 /Fax: 0757-25530628

网址 /Web: <http://www.gdkaihua.com/>

广东凯华电器股份有限公司成立于 1999 年,经过 24 年的不断发展,产品已经通过很多国际认证,如 CCC, VDE, UL, PSE, SAA, BSI, IMQ, CSA, INMETRO, IRAM, SABS, BSMI, SII, KC, ASTA, SEV, GCC, SASO 等, and ROHS REACH certifications.

现有 200 多款产品,月产量 10,000,000 条。凯华热忱欢迎国内外客人参观。

Guangdong KaiHua Electric Appliance Co., Ltd. established on 1999. After 24 years developing

and expanding, our products already passed many international approvals, such as: CCC, VDE, UL, PSE, SAA, BSI, IMQ, CSA, INMETRO, IRAM, SABS, BIS, BSMI, SII, KC, ASTA, SEV, GCC, SASO and RoHS, REACH certifications. Our catalogues have more than 200 models and capacity is about 10 million per month. Warmly welcome to visit us.

**主要展品 /Products**

插头电源线, 适配器

power wire and plugs, power supply manufacturer



—消毒专家·健康守护—

**广东康宝电器股份有限公司**

**N1-1C61**

**Guangdong Canbo Electrical Co.,Ltd.**

地址: 广东省佛山市顺德区杏坛镇齐新路 268 号 (528311)

Add: No.268 Qixin Road, Xingtan Town, Shunde District, Foshan City, Guangdong

电话 /Tel: 0757-27389018

传真 /Fax: 0757-27389018

网址 /Web: <http://www.canbo.cn>

1988 年 1 月,康宝独立自主研发的世界上第一台家用电子消毒柜成功诞生,并开创了世界消毒柜家电品类!并荣获“中国家电行业十大影响力品牌”、“中国最有价值品牌 500 强”、“国家标准创新贡献奖一等奖”、2021 年中国厨卫行业十大影响力品牌、2022 年中国厨卫领军大奖等系列殊荣!康宝产品涵盖消毒柜、抽油烟机、燃气灶、智能家居等。其中康宝消毒柜连续 10 年全国销量第一!被誉为“世界消毒柜王国”。

In January 1988, Canbo independently invented the world's first household electronic disinfection cabinet.

Canbo won the first prize of "National Standard Innovation Contribution Award";

2020 Top ten Brands of Kitchen and bathroom appliances in China;

Canbo won "2021 Germany iF Design Award", 2021 Chinese kitchen appliance brand trusted by consumers, Top 10 influential brands in China's kitchen and bathroom industry in 2021, and China's kitchen and bathroom leading prize in 2022 etc

the products are exported to all over the world and all over the domestic large and medium-sized cities, known as the "disinfection kingdom of the world".

**主要展品 /Products**

产品涵盖消毒柜、抽油烟机、燃气灶、热水器、净水器、空气净化器、烤箱、商厨电器、智能家居等。其中,康宝消毒柜连续 10 年全国销量第一! 35 年外贸经历,产品远销世界各地及遍布国内大中城市,被誉为“世界消毒王国”。

Canbo has obtained more than 90 R&D patents, covering disinfection cabinet, range hood, gas stove, water heater, water purifier, air purifier, oven, kitchen appliances, smart home and so on.

And Canbo disinfection cabinet's sales volume is the first for 8 consecutive years in China! More than 30 years of foreign trade experience, the products are exported to all over the world and all over the domestic large and medium-sized cities, known as the "disinfection kingdom of the world".

## CONFU康夫

广东康夫电器有限公司

GUANGDONG CONFU ELECTRICAL APPLIANCES CO.,LTD

地址: 广东省揭阳市空港经济区天福路以东渔十三路以北 (522021)

Add: North of Yu 13 Road, east of Tianfu road, Jieyang airport economic zone,

Guangdong Province

电话 /Tel: 0663-8329369

传真 /Fax: 0663-8328598

康夫集团以创造美好生活为依托, 致力于以电吹风为主导, 直卷发器、理发器等系列美发工具的研发与制造。

康夫集团拥有现代化生产规模和先进生产管理生态系统, 荣获多项国家级荣誉奖项。

近 30 年以来, 康夫以品质引领国内市场, 产品远销全球 40 多个国家和地区, 为康夫百年品牌的美好愿景铸就坚实基础。

Based on the idea of creating a better life, we are committed to the development and manufacture of hair care tools, such as hair curlers, hair clippers and hair dryers. CONFU Group has a modern production scale and an advanced production management ecosystem, having won a number of national honorary awards. For nearly 30 years, CONFU has led the domestic market with quality, and its products have been sold to more than 40 countries and regions all over the world, laying a solid foundation for its century-old brand vision.

主要展品 /Products

电吹风、直卷发器、理发器

Hair Dryer, hair straightener, hair clipper



广东酷宁电器科技有限公司

地址: 广东省东莞市横沥镇山厦四海工业区第 4 栋 (523462)

电话 /Tel: 0769-83790018

传真 /Fax: 0769-83790018

网址 /Web: www.coolwhist.en.alibaba.com

酷宁科技成立于 2010 年, 坐落在以制造闻名的东莞市横沥镇; 公司拥有独立的工程研发团队, 自成立以来一直秉承“为员工创造梦想, 为客户创造价值”的经营方针, 致力于小家电产品的研发和生产。酷宁科技已是同行业中最专业的家用小除湿机制造商。

公司主要生产家用除湿器、加湿器、空气净化器、制冷器等产品; 公司有 ISO9001 2008 体系认证, 也已通过 BSCI 认证。

期待和客户全方位合作, 一起创造更广阔的未来。

主要展品 /Products

家用除湿器、加湿器、空气净化器、制冷器等。

E3-3C51

W5-5A47

## LESSO 领尚

广东联塑科技实业有限公司

地址: 广东省佛山市顺德区龙江镇联塑工业村 (528318)

电话 /Tel: 0757-23888333

传真 /Fax: 86-757-23888555

网址 /Web: www.lesso.com

中国联塑集团控股有限公司 (简称: 中国联塑, 股份代号: 02128.HK) 是国内大型管道建材产业集团, 业务涵盖管道、建材家居、环保、供应链服务平台、光伏新能源等板块, 产品涉及管道、光伏新能源、水暖卫浴、整体厨房、整体门窗、铝模板材及智能爬架、净水设备、防水与密封胶、消防器材、阀门、电线电缆、照明、卫生材料、环境保护、农业设施、海洋养殖网箱等领域。2021 年集团营业收入达 320.58 亿元人民币。

主要展品 /Products

净水机

空气净化器

N3-3G86

## ROAMAN 罗曼

广东罗曼智能科技股份有限公司

GuangDong Roman Technology Co., Ltd.

地址: 广东省东莞市樟木头镇金河新光路 18 号 (523000)

Add: No.18 Xinguang Road, Jinhe District, Zhangmutou Town, Dongguan City, Guangdong Province, China

电话 /Tel: 0769-89009969

网址 /Web: www.roaman.cn

广东罗曼智能科技股份有限公司成立于 2006 年, 公司专注电动牙刷、冲牙器等口腔健康电器 18 年, 是国家高新技术企业、国家级专精特新“小巨人”企业、电动牙刷行业标准起草单位、冲牙器行业标准唯一起草单位。公司现拥有技术发明专利等专利累计 809 项, 凭借医学专业标准和产研一体化实力, 罗曼产品畅销欧、美、日等全球 18 个国家和地区, 超过 10000 家口腔门诊 (口腔医院) 选择罗曼, 进驻国内超过 3000 线下终端。

主要展品 /Products

电动牙刷、冲牙器、高速电吹风、口腔周边产品等

E3-3E21

M A K  
interconnection

## 美领互联+

广东美领互联科技股份有限公司

Guangdong Meiling Internet Technology Co., Ltd.

地址: 中山市南头镇尚义路 8 号首层之二 (528427)

Add: 2/f, 8 Shangyi road, Nantou, Zhongshan

电话 /Tel: 0760-23131111

传真 /Fax: 0760-23131111

网址 /Web: http://www.zgmlsj.com/

E2-2C21

美领互联总部位于广东中山, 是一家以供应链生产研发和品牌运营为核心能力的公司, 旗下运营



国内外十几个知名品牌,此次 AWE 展我们带来 2 个历史悠久的国际品牌:德国蓝宝 (BLAUPUNKT) 和韩国大宇 (DAEWOO)。

美领互联擅长互联网资源整合,通过搭建产品研创中心、文化传媒中心、品牌运营孵化中心、创意视觉中心及客户服务中心,连接品牌、产品、传媒、分销与消费终端,构筑了一站式全链条品牌能力共享平台。

Guangdong MeiLing Internet Technology Co., Ltd. is headquartered in Zhongshan city, Guangdong province. Our core competence lay in supply chain production R&D and brand operation, we operate more than a dozen well-known brands at home and abroad. This time we have two international brands with long history on the AWE 2020: BLAUPUNKT, DAEWOO. MeiLing has been focused on integrating internet resources and sharing brand capability. We have established five sections connecting all brands, products, new marketing, omni-channel and consumption endpoint, which are product research and innovation center, culture media company and brand operation incubation center, creative visual center and customer service center, building the brand capacity sharing platform of one-stop full chain brand ability.

#### 主要展品 /Products

产品涉及空调,冰箱,洗衣机,厨房生活电器,个护健康,保健按摩,智能安防等诸多领域。

Air conditioning; Refrigerator; Washing Machine; Kitchen appliances; Personal Care Products; Medical & Fitness Products; Home Security and Home Automation Systems and so on.

## MEISU 美苏

广东美苏智能科技有限公司

Guangdong Meisu Electrical Appliances Co.,Ltd

N1-1A30 1A31

地址:广东省中山市东凤镇兴华东路 82 号 (528425)

Add: No.82,Xinghua East Road,Dongfeng Town,Zhongshan City,Guangdong,China

电话 /Tel: 0760-22773331

传真 /Fax: 0760-22781665

网址 /Web: <https://meisu.en.alibaba.com/>

广东美苏智能科技有限公司创办于 2009 年,并致力于新产品开发与研究。2018 年,美苏已经成为了中国最大、研发能力最强的多功能电煮锅制造商。2019 年,为了满足更多的小家庭产品需求,产品扩展到电煎锅,电火锅,即热式饮水机,空气炸锅等。

Guangdong Meisu Intelligent Technology Co., Ltd. was founded in 2009, and is committed to new product development and research. In 2018, Meisu has become China's largest manufacturer of multifunctional electric cookers with the strongest research and development capabilities. In 2019, in order to meet the needs of more small family products, products expanded to electric frying pan, electric hot pot, instant hot water dispenser, air fryer, etc.

#### 主要展品 /Products

电煮锅,电火锅,空气炸锅,即热式饮水机,电煎锅,电蒸锅,暖被机

Electric cooker, electric hot pot, air fryer, instant hot water dispenser, electric frying pan, electric steamer, heating machine.

## MEZIC<sup>®</sup>

美智智能

广东美智智能科技有限公司

GUANGDONG MEZIC TECH.,LTD

W4-4A08

地址:佛山市顺德区勒流街道新安工业区 (528300)

Add: Xin'an Industrial Park,Leliu Town,ShundeDist.Foshan City,Guangdong Prc.China

电话 /Tel: 0757-23663306

传真 /Fax: 0757-23663636

网址 /Web: [www.mezic.cn](http://www.mezic.cn)

广东美智智能科技有限公司是集研发、制造、销售和服务为一体的国家高新技术企业;公司成立于 2006 年,现有员工 600 多人,公司厂房面积 4 万多平米,控制器年生产能力 2000 万套。公司是广东省家电智能控制器工程技术研究中心,广东省民营科技企业。

依托强大的研发能力、高效的自动化水平、完善的信息化体系、极致的品控要求,美智将为全球客户提供提供行业领先的智能控制器和系统智能化解决方案。

MEZIC is a national High-Tech enterprise integrating R&D,manufacturing,sales and after-sale service.The company was founded in 2006,which takes up more than 40,000 m<sup>2</sup>.Now we have more than 600 employees and our annual production capacity can reach to 20,000,000 units. Our major products are Heating table controllers,Gas boiler controllers,Electronic door lock controllers,Smart bidet controllers and Household electrical appliances controllers. Relying on powerfui R&D capacity ,high efficiency of automation,impeccable information system and ultimate requirement on quality,we will keep supplying trustable and intelligent control system to our customers all over the world.

#### 主要展品 /Products

公司产品系列有:电暖桌控制器、壁挂炉控制器、智能锁控制器、智能马桶控制器、家电控制器等。

Our major products are Heating table controllers,Gas boiler controllers,Electronic door lock controllers,Smart bidet controllers and Household electrical appliances controllers.



广东米德加德电器科技有限公司

GuangDong Midgard Electrical Appliance Co.,Ltd

W3-3A12

地址:广东省佛山市顺德区龙江镇仙塘村西区一路 8 号之一顺德万洋众创园 7 栋 101 (528000)

Add: (No.101,Building7,Wangyang zhong chuang Garden)No.8,Road1,West

area,Xintang,Longjiang,Shunde,Foshan,Guangdong,China

电话 /Tel: 13923288475

传真 /Fax: 0757-22361362

网址 /Web: <https://shop043m749f48777.1688.com>

随着 90 后、00 后消费观念的成熟,其逐渐成为消费主力。个性化的产品成为市场主流,公司着力打造自己的品牌,拥有自主知识产权,发明专利走创新发展的道路,紧贴市场快速反应研发新产品。销售方面主要通过国内线上、国内礼品、茶市场的特定渠道;跨境电商,国内线上渠道(初期以东南亚市场泰国、印尼、越南、韩国、日本、台湾等市场为主)公司项目以品牌培育、建立营销渠道为主。侧重于产品研发、市场营销、精益生产。

Unique and Customized products tend into the main market with the 90s & 00s Consumption Concept improved. Midgard devote to develop and research own brand, IP and patent. we innovate new products and follow up market. Our business establish wild of world, such as most of gift and tea-market exhibitions in China, domestic on-line platform include Taiwan, international platform, Thailand, Vietnam, South Korea, Japan etc....

Midgard focus on brand cultivation and the establishment of marketing channels, what's more, product research, marketing build, high-quality production is our aim.

#### 主要展品 / Products

奶泡机、电热水壶、煮茶器、磨豆机、便携式电热水杯、电蒸笼、爆米花机。

Milk Frother, Electric Kettle, Tea Cooker, Grinding Machine, Portable Water Jug, Food Steamer, Popcorn Maker.



#### 广东耐思菲特电气有限公司

**N4-4B06**

地址: 广东省湛江市麻章区金康西路 34 号 (524094)

电话 /Tel: 0759-3638178

网址 /Web: <http://nice-fit.com.cn/>

广东耐思菲特电气有限公司成立于 2019 年, 位于中国美丽的大陆最南端 -- 广东省湛江市, 是一家专注智能、健康和环保的中高端护理型家电系列产品的研发、生产和销售为一体的新型技术企业, 其中包括智能干洗衣物护理机等多种中高端护理型家电。公司拥有丰富的研发和生产经验, 年生产能力达数十万台, 是国内自有品牌为数不多的中高端护理家电生产商之一。

#### 主要展品 / Products

衣物护理机



#### 广东南星玻璃有限公司

**N2-2B12**

**Guangdong South Star Glass Limited**

地址: 广东省佛山市三水区乐平镇三水中心科技园拓业路 6 号 (528137)

Add: #6 Tuoye Road Leping Technology Zone, Sanshui District Foshan City, Guangdong

528137 P.R.China

电话 /Tel: 0757-66899008

传真 /Fax: 0757-66899008

南星公司位于广东佛山市, 现代化厂房配备整套加工设备。主营各种家居家电用玻璃面板。服务于高难度, 高端定制的玻璃面板市场。

GOOD GOOD PRODUCT, MAINLY IN THE DIGITAL PRINTING GLASS PANEL. FLAT-CONCAVE IN ONE CERAMIC GLASS PANEL. SERVICE TO THE GLASS PANEL MARKET OF THE HIGHLY COMPLICATED AND THE HIGH CLASS CUSTOMIZED.

SOUTHSTAR LOCATED IN FOSHAN, GUANGDONG. WE HAVE THE COMPLETE SET OF PROCESSING EQUIPMENTS AND THE MODERN WORKSHOP.

#### 主要展品 / Products

平凹一体微晶玻璃面板。

耐高温打印彩色玻璃面板

Flat-concave in one ceramic glass panel

Ceramic printing glass panel

## 七彩叮当

URINGO

#### 广东七彩叮当智能科技有限公司

**N3-3F61**

URINGO

地址: 广东省佛山市顺德区大良街道北区社区绿田路创客中心 B 栋 (517200)

Add: Building B, Chuangke Center, Lvtian Road, north community, Daliang Street, Shunde District, Foshan City, Guangdong Province

电话 /Tel: 0757-22284312

传真 /Fax: 13682293176

网址 /Web: <http://www.uringo.cn/>

七彩叮当创立于 2017 年, 深耕小家电领域, 品牌设有产品研发中心和营销中心, 拥有研发、销售、营销的全链条综合能力, 成立之初, 我们将“微创新、高品质、高颜值”作为品牌核心理念。

七彩叮当产品设计简约, 色彩丰富, 兼具多功能、多场景、多趣味特征传递“爱美爱玩爱探索、可晒宅可健康”的年轻态度, 为消费者创造美好、舒适、温暖的生活体验。

Established in 2017, Qicai Dingdang is a brand in the field of small household appliances. The brand has a product research and development center and a marketing center, we Will “Micro-innovation, high quality, high beauty” as the core concept of the brand. Colorful jingle products design simple, colorful, both multi-functional, multi-scene, multi-interesting features to convey the “Love of beauty, love to play, love to explore, Sun can be curtilage can be healthy” young attitude, for Consumers to create a good, comfortable, warm life experience.

#### 主要展品 / Products

厨房电器: 多功能锅、养生壶、空气炸烤箱、无线榨汁机、绞肉机、净化水龙头、冰箱除味器、破壁机等  
生活电器: 加湿器、便携式干衣机等。

Kitchen appliances: Multi-functional Pot, health pot, air FRY oven, wireless juicer, meat grinder, purification faucet, refrigerator Deodorizer, broken wall machine and other appliances:  
humidifier, portable clothes dryer



#### 广东丘比尔实业有限公司

**W4-4B26**

**GUANGDONG QBILL INDUSTRIAL CO.,LTD.**

地址: 广东省佛山市顺德区勒流街道办上涌工业区泰和路 6 号 (528322)

Add: No.6 taihe road shangyong zone leliu town, shunde foshan China

电话 /Tel: 0757-25528084

传真 /Fax: 0757-25528484

网址 /Web: [www.qbillworld.com](http://www.qbillworld.com)

广东丘比尔实业有限公司成立于2004年,经过超过15年的努力,我们成为一家专业制造电暖袋、电风扇、智能家电的公司。我们的产品通过了德国GS,美国ETL,加拿大CETL,欧共体CE、CB、REACH、ROHS、澳洲SAA、日本PSE、SMARK等认证。我们以“以人为本”的经营理念 and 诚信,致力于为客户提供优质的产品和完善的服务,产品远销世界各地,深受广大客户的好评。

Guangdong QBILL Industrial Co., Ltd was established in 2004, by our over 15 years effort, we now become a professional manufacturer of electric hot water bottle, rechargeable USB fan, USB heat pad and ultrasonic humidifier.

Our products have gained the Europe, USA, Japan and Australia technology patent. Passed GS, ETL, CETL, CE, CB, SAA, S MARK, PSE, REACH, ROHS ect approval. We dedicate to providing high quality products and best service through people-orient management concept and trustworthiness.

Now our products have been exported to all over the world and got high reputation from customers. Our target is to satisfy customer's needs by providing the high quality, accurate delivery and competitive price. Now, Guangdong QBILL Industrial Co., Ltd is one strong, aggressive corporate which stands before eyes of the world.

#### 主要展品 /Products

电暖袋, 可充电循环风扇。

Electric hot water bag, Foldable Recharge Fan.



#### 广东瑞德智能科技股份有限公司

Guangdong Real-Design Intelligent Technology Co., Ltd.

W4-4G71

地址: 广东省佛山市顺德区大良凤翔工业园瑞翔路1号 (528300)

Add: No.1 Ruixiang Road, Fengxiang Industrial Park, Daliang Town, Shunde District, Foshan City, Guangdong Province, China

电话 /Tel: 075729961812

传真 /Fax: 075729961996

网址 /Web: www.realdesign.com.cn

广东瑞德智能科技股份有限公司, 1997年2月成立于佛山市顺德区, 注册资本7646.4万元。公司主营业务为智能控制器的研发、生产与销售, 以及少量终端产品的生产和销售。公司主要产品包括厨房电器、生活电器、环境电器等各类小家电智能控制器, 并逐步向大家电、医疗健康、电动工具、智能家居等领域进行渗透和拓展。

#### 主要展品 /Products

公司主营业务为智能控制器的研发、生产与销售, 以及少量终端产品的生产和销售。公司主要产品包括厨房电器、生活电器、环境电器等各类小家电智能控制器, 并逐步向大家电、医疗健康、电动工具、智能家居等领域进行渗透和拓展。



#### 广东三角牌电器股份有限公司

N3-3E71

地址: 广东省梅州高新技术产业园区

电话 /Tel: 020-83340192

网址 /Web: http://www.gdtri.com/

2017年8月, 公司成立, 2021年9月, 提级管理为广州轻工集团二级重点企业。拥有2个中国驰名商标老字号品牌: 三角牌(注册于1966年)、钻石牌(注册于1964年), 主营厨房小家电, 通风类电器, 小家电年销量1100万台; 22年电商销售GMV: 2亿。公司拥有广州轻工智能家电产业集群梅州产业园, 占地403亩, 整合10家工厂(8家三角、钻石牌许可厂+2家配套厂), 日产能最高达5万台小家电。

#### 主要展品 /Products

不沾直升锅, 不锈钢直升锅, 电蒸锅, 电炖锅, 连体锅, 智能煲, 脱糖智能煲, 西施煲, 压力锅, 多功能用锅, 压铸多功能锅, 电煮锅, 电磁炉, 超薄静音破壁机, 包胶电水壶, 不锈钢电水壶, 机械落地扇, 遥控落地扇, 喷雾落地扇, 商用牛角扇, 趴地扇, 台扇, 吊扇, 带灯吊扇, 循环扇, 塔扇, 风幕机。



SOSEKI

#### 广东善思科技有限公司

N3-3C31

Guangdong Soseki Tech. Ltd., Co.

地址: 广东省佛山市顺德区北滘镇广东工业设计城三期东座4楼

电话 /Tel: 0757-22396458

广东善思科技有限公司(简称: 善思科技)

一家集产品研发、生产制造、全球销售等为一体的品牌管理公司。以“中国高端小家电领导品牌”为企业愿景, 制定全产业链布局、以创新类产品为核心, 共创国际化品牌。旗下运营 BRUNO 及善思两大品牌, 以“立足用户, 创造价值”为产品理念, 致力为人们提供健康、美丽、舒适的生活解决方案。

#### 主要展品 /Products

公司旗下运营两大品牌:

BRUNO 高端厨房小家电, 旗下三大产品系列, 以空气炸锅、多功能料理锅为代表西式系列; 以电压力锅、电饭煲为代表的中式系列; 以破壁机、养生壶为代表的水料系列, 深受消费者喜爱。

善思智能清洁小家电, 以内衣洗烘一体机为代表, 用颠覆洗护行业的清洗科技解放女性双手。



SOUNDWELL®

广东升威电子制品有限公司

SOUNDWELL ELECTRONIC PRODUCTS GUANGDONG CO.,LTD

N1-1B42

地址: 广东省东莞市塘厦镇凤凰岗工业区凤清路升威工业园 (523700)

Add: Soundwell Industry Park, Feng Qing Road, Fenghuanggang Village, Tangxia Town,

Dongguan City

电话 /Tel: 076938833333

传真 /Fax: 076987930111

网址 /Web: www.soundwell.cn

升威电子成立于 1991 年, 公司拥有自主品牌及自有技术研发团队, 通过 ISO9001、ISO14001、IATF16949 和获得 SONY GP 认证, 公司凭借 30 余年的专业经验, 成为编码器行业标准制定单位, 现有生产的产品种类已达七万多种规格, 主要广泛应用于汽车电子、家庭音响、多媒体、调音台、对讲机、电子玩具、家用电器、智能家居、航空航天、军工、物联网等领域。欢迎各界朋友与升威携手共进, 合作共赢!

Soundwell Electronics was founded in 1991, the company has its own brand and its own technology development team, through ISO9001, ISO14001, IATF16949 and SONY GP certification, with more than 30 years of professional experience, the company has become the encoder industry standard setting unit, the existing production of more than 70,000 kinds of products. It is widely used in automotive electronics, home audio, multimedia, mixer, walkie-talkie, electronic toys, household appliances, smart home, aerospace, military, Internet of things and other fields. Welcome friends from all walks of life to join hands with Soundwell, win-win cooperation!

**主要展品 /Products**

主要产品系列有: 编码器、电位器、传感器、开关、屏显模组等产品。

Main products series have encoder, potentiometer, sensors, switches, OLED/LCD modules.

**ULESM**

广东省无叶科技有限公司

Guangdong Wuye Technology Co., Ltd.

E3-3H81

地址: 广东省东莞市松山湖园区晨夕路 1 号 1 栋 1201 室

Add: Room 1201, Building 1, No. 1, Chenxi Road, Songshan Lake Park, Dongguan City,

Guangdong Province

电话 /Tel: 13710162100

网址 /Web: www.ooyee.cn

公司秉承科技创新, 以人为本, 联合共赢, 对产品精益求精, 奔着极致追求、创造符合时代潮流感的科技型公司迈进。团队于 2017 年组建, 经过重重磨练, 2018 年深圳公司搬迁, 2020 年经历过行业技术的沉淀且破茧而出, 成功研发了以“ULESM 尤勒斯”品牌无叶高速吹风机

The company adheres to scientific and technological innovation, people-oriented, win-win cooperation, strives for product excellence, pursues the ultimate pursuit, and creates a technology-based company that conforms to the trend of the times.

step forward. The team was established in 2017. After a lot of hard work, the Shenzhen company expanded and relocated in 2018. In 2020, it experienced the precipitation of industry technology and emerged from the cocoon, successfully Developed a leafless high-speed hair dryer under the brand "ULESM"

**主要展品 /Products**

负离子无叶吹风机

Negative ion leafless hair dryer

**EDON 爱登**

广东顺德爱登创意日用品有限公司

E2-2H61

地址: 佛山市顺德区北滘万联中心 901-905 室

电话 /Tel: 0757-26661062

网址 /Web: http://www.edonlive.com/

EDON 爱登创立于 2008 年, 是一家集自主研发设计、生产和销售为一体的创意家电公司, 占地面积 16000 平方米, 员工 400 多人。

EDON 爱登产品深受中国乃至世界各地消费者的欢迎, 年产销 400 多万个产品, 线下已跟全球最大连锁沃尔玛、山姆会员店、大润发、华润万家、永旺、永辉等大型超市长期合作。同时公司也是名创优品、NOME、韩国 Ineu、韩国 SHINIL 等国内外众多品牌的 OEM 生产供应商。

**主要展品 /Products**

风扇、加湿器、香薰机、暖风机、电热水袋



广东顺德迪泰隆电器有限公司

N1-1B40

Guangdong Shunde Detlone Electrical Appliances Co.,Ltd

地址: 广东省佛山市顺德区均安镇智安北路 9 号 (528329)

Add: No. 9, Zhi'an North Road, Jun'an Town, Shunde District, Foshan City

电话 /Tel: 075729363666

传真 /Fax: 075729973330

网址 /Web: http://www.fsdltl.com/

迪泰隆电器公司创建于 2012 年, 座落于顺德, 专注于生产厨房小家电, 研发、生产和销售于一体, 创建自主的核心独立品牌。有空气炸锅、多功能煮食锅、料理机、搅拌机 etc 厨房小家电, 取得国内外多项发明专利, 并通过 CCC, CE, CB, ETL, GS, ROHS, LFGB 和其他国际认证。公司秉承“质量第一, 客户至上”的宗旨, 为客户提供最好的产品和优良的服务。欢迎国内外朋友前来洽谈, 共图发展。

Guangdong Shunde Detlone Electrical Appliances Co.,Ltd, It has obtained ISO9001:2008 quality system approval.

Detlone is a professional manufacturer of small kitchen appliance, integrating development and production together and has its own core independent brands. The main products include Air-fryer, Multi functional Cooker, Slow Cooker, Thermo-mixer, blender and other small kitchen appliances. Most of them have passed 3C, CE, GS, CB, ETL, UL, ROHS, LFGB and other international approvals.



Additionally, the company implements the modern enterprise management and adheres to independent innovation and provides related R&D services, such as market strategy, design research, product realization, mould research, product test certification and production technique research of OEM & odm projects, which can fulfill the one-stop purchase demand of the international famous brands of retailer. Detlone will stick to the developing strategy of "realizing the increase with good quality".

#### 主要展品 /Products

空气炸锅、多功能煮食锅、料理机、搅拌机、电烤炉和其他厨房小家电。

Air-fryer, Multi functional Cooker, Slow Cooker, Thermo-mixer, blender and other small kitchen appliances.

## DOUHE 斗禾

### 广东顺德斗禾电子科技有限公司

#### Guangdong Shunde DOUHE Electronics Technology Co., Ltd

E2-2E71

地址: 广东省佛山市顺德区北滘镇顺江居委会工业园置业路 8 号 1-4 层 (528300)

Add: A Building Zhiye Road, Beijiao Town, Shunde District, Foshan City, Guangdong Province, China

电话 /Tel: 0757-26605206

网址 /Web: http://www.douhe-tec.com

斗禾集团, 成立于 2014 年, 是一家集工业设计 - 研发 - 制造 - 营销为一体的小家电制造高新技术平台企业, 目前拥有环境电器以及厨房小家电产品线, 原创设计打造全球小家电品牌。斗禾始终坚持以设计创新为驱动, 提升用户体验为出发点, 300 多项国家技术专利以及多款高新技术产品。斗禾集团 21 年提出了“设计生态圈”+“沃土制造生态圈”+“品牌出海生态圈”三圈合一的创新运营模式, 助力打造全球最具创造力的家电生态平台。

DOUHE Group was established in 2014, which is a small home appliance high-tech ecological platform enterprise integrating industrial design, R&D, manufacturing, and marketing. The main products are environmental health products.

DOUHE has always insisted on taking design innovation as the driving force and improving user experience as the starting point, and strives to create a series of high-quality products that improve the quality of life. It has a complete technology development, quality management and after-sales services system, and owns more than 300 national technology patents and a number of high-tech products.

DOUHE are adhering to the core values of righteousness, righteous words and righteous actions. We will insist on providing high-quality, healthy and environmentally friendly, excellent craftsmanship, and ultimate experience of the new era products, so as to realize the yearning of all mankind for a better life.

#### 主要展品 /Products

电暖器, 除湿机, 空气净化器, 加湿器, 灭蚊器, 电蚊拍, 驱蚊器, 循环扇, 厨房小家电。

Electric Heater, Dehumidifier, Air Purifier, Humidifier, Mosquito Killer, Electric Fly Swatter, Mosquito Dispeller, The circulation fan, Kitchen appliance.



### 广东顺德刚辉橡胶金属制品有限公司

#### Guangdong Shunde Kwongfai Rubber & Metal Ltd

N4-4B12-3

地址: 佛山市顺德区容桂南区达盛路一横路 9 号 (528300)

Add: No.9, Yiheng Road, Dasheng Avenue, Nanqu, Ronggui, Shunde District, Foshan, Guangdong, P.R. China

电话 /Tel: 0757-28305088

网址 /Web: www.sdkwongfai.com

广东顺德刚辉橡胶金属制品有限公司, 成立于 2000 年。我司一直采用现代科学的管理模式, 积极推行 ISO9001 体系品质管理系统和 ERP 管理系统。2020 年新增设 10 万级 LSR 无尘车间, 取得并实施 ISO13485 医疗器械生产管理体系。

我可能提供符合美国 FDA, 欧盟 RoHS, REACH, 德国 LFGB, 法国 DGCCRF, 欧盟 1935/2004/EC 及其他多国食品接触及卫生标准的硅橡胶产品。

SHUNDE KWONGFAI RUBBER WAS ESTABLISHED IN 2000, WE ADOPT ISO9001 QUALITY CONTROL SYSTEM AND ERP MODERN SCIENTIFIC MANAGEMENT TO ENSURE PRODUCTION AND QUALITY CONTROL REQUIREMENT. IN 2020, WE HAVE BUILT 100,000 CLASS LSR CLEAR ROOM, AND IMPLEMENTED ISO13485 MEDICAL EQUIPMENT PRODUCTION MANAGEMENT SYSTEM.

OUR PRODUCT CAN COMPLY WITH FDA, RoHS, REACH, LFGB, DGCCRF AND MOST OF THE RULES AND REGULATIONS IN DIFFERENT COUNTRIES.

#### 主要展品 /Products

硅橡胶定制件, 产品应用广泛包括小家电、卫浴用品、工业设备、汽车、医疗用品等。

We are manufacturer of rubber and silicone custom product, include the field of home appliance, bathroom fitting, auto part, medical product part.



### 广东顺德骏特电器股份有限公司

#### Junte Electrical Appliances Co., Ltd.

N3-3A49

地址: 佛山市顺德区北滘镇高村工业区 5 路 6 号 (528311)

Add: GAOCUN INDUSTRY ZONE, BEIJIAO, SHUNDE, FOSHAN, GUANGDONG, CHINA

电话 /Tel: 0757-66882137

传真 /Fax: 0757-66882130

网址 /Web: www.junte.com.cn

公司成立于 1997 年, 是两季家电产品专业制造商, 主要生产电风扇、吊扇、取暖器, 电熨斗。公司已通过“ISO9001: 2015 质量管理体系”认证, 产品获得 ETL、GS、CE、SASO、CCC 等认证。

现拥有 5 万平方米的厂房, 固定资产 5000 万元, 年生产能力 300 多万台电器, 500 多名员工。拥有设计开发, 模具设计制造, 注塑加工, 五金加工, 电机设计制造, 五金喷涂, 网罩加工, 成品组装一条龙的生产 and 设计能力。

Junte Electrical Appliances Co., Ltd. was established in 1998, specializes in Electric heater, Electric fan, Ceiling fan, Steam press and provide OEM service, annual production capability reaches 3,000,000 sets of ceiling fans and electric fans, 600,000 sets of Steam press and

500,000 sets of Electric heaters. Our factory covers 50,000 square meters and we have whole industrial settings included plastic injection, metal punching, motor manufacturing, grille workshop and mould making. Junte runs under modernized management model and has been approved by ISO 9001: 2000 International System of Quality Management. Most of our products have ETL, CE, CCC certificate. Strict quality control is implemented to make sure that 100% of the products could pass the quality examination before leaving factory. The R & D team with experienced engineers and skilled technicians is good at developing and innovating products rapidly. We warmly welcome OEM and ODM businesses.

#### 主要展品 /Products

电暖器, 陶瓷 PTC 暖风机, 塔式 PTC 暖风机, 对衡式电暖器, 电风扇, 充电风扇, 塔扇, 落地扇, 壁扇, 台扇, 商务扇, 吊扇, 电烫机。

Electric heater, Electric ceramic heater, Tower ceramic heater, Convection Heater, Electric Fan, Rechargeable Fan, Tower Fan, Stand Fan, Wall Fan, Table Fan, Commercial Fan, Ceiling Fan, Steam Press, Steam Iron.



mikodesign

广东顺德米壳工业设计有限公司

Mikodesign

地址: 佛山市顺德区北滘镇三洪奇居委会三乐路北 1 号 F 栋 1 楼西座

电话 /Tel: 29893060

米壳设计 (MIKO Design), 成立于 2014 年, 拥有顺德, 深圳, 江西三大设计中心, 致力于成为一家面向国际的创新设计团队。米壳团队坚持以用户体验为核心, 专注于为客户提供全方位战略咨询及设计服务, 服务范围涵盖工业设计、品牌策略及设计、视觉设计、会展设计、用户体验设计等多个方向, 聚焦智能家居、生活家电、美容个护、智能装备、医疗器械、文化产品等领域。

#### 主要展品 /Products

家居电器、厨房电器、3C 电子



凝卓智能  
LINKJOB

广东顺德凝卓智能科技有限公司

Guangdong Shunde ningzhuo Intelligent Technology Co., Ltd

地址: 广东省佛山市顺德区容桂街道扁滘社区兴华东路 26 号兴华楼 204 (528305)

Add: 204, Xinghua building, No. 26, Xinghua East Road, Bianjiao community, Ronggui street,

Shunde District, Foshan City, Guangdong Province

电话 /Tel: 13068667546

传真 /Fax: 0757-26385858

网址 /Web: www.gdlinkjob.com

E2-2C51-02

W3-3B31

凝卓智能坐落于广东顺德容桂, 是专业从事“物联网产品与平台”设计、开发、服务于一体的创新型企业。公司主营业务为智能家电与智能家居的技术开发, 物联网云平台的开发。公司可提供整套完善的解决方案。在智能家电方面提供通讯模组开发, 移动端开发, 共享产品提供全套产品开发, 已为上百家公司成功开发了两百多款产品。凝卓智能 -- 凝于匠心, 卓于追求, 智造生活, 无限可能!

Ningzhuo intelligence, located in Ronggui, Shunde, Guangdong, is an innovative enterprise specializing in the design, development and service of "Internet of things products and platforms". The company's main business is the technology development of smart appliances and smart homes, and the development of Internet of things cloud platform. The company can provide a complete set of perfect solutions. In terms of smart appliances, it provides communication module development, mobile terminal development and shared products, and provides a full set of product development. It has successfully developed more than 200 products for hundreds of companies. Congealing intelligence - congealing in ingenuity, congealing in pursuit, wisdom makes life, infinite possibilities!

#### 主要展品 /Products

APP 开发、智能产品方案、物联网产品方案、共享租赁整套解决方案、WIFI 模块、BLE 模块、4G 模块、物联网平台。

App development, intelligent product solutions, Internet of things product solutions, sharing and leasing solutions, WiFi module, ble module, 4G module, Internet of things platform.



广东顺德奇伟电器科技有限公司

N3-3B42

地址: 广东省佛山市顺德区容桂华口华发路 13 号 2 号楼 2 楼

电话 /Tel: 0757-28378804

广东顺德奇伟电器科技有限公司, 是一家以创新为核心, 自主研发、生产和销售“创新型小家电”的综合性企业。现主要产品有: 多功能养生壶、果汁机、既热开水机、电热水杯、折叠水壶等各类生活厨电。

奇伟电器以卓越科技、创新生活的竞争策略, 经营自主品牌的同时更持续拓展 OEM、ODM 代工生产业务, 公司产品还出口到香港、台湾、韩国和亚太国家等地区, 亦与多家国内知名家电巨头建立长期合作关系。

#### 主要展品 /Products

多功能养生壶、果汁机、既热开水机、电热水杯、折叠水壶等

## CHINNO 潜龙设计

广东顺德潜龙工业设计有限公司

E2-2C51-06

Chinno Industrial Design Co., Ltd.

地址: 广东省佛山市顺德区北滘镇三乐路北一号广东工业设计城 G 栋

电话 /Tel: 13450819572

潜龙设计是一家“以产品创新为核心”的品牌 + 产品 + 服务一体化全案设计公司, 成立于 2002 年, 是国家高新技术企业, 立足顺德, 服务全球的品牌商、制造商、渠道商。

擅长根据企业经营顶层设计, 实施产品战略、产品线规划、供应链管理、新品孵化。

拥有近 50 名资深策划师、设计师、工程师设计团队, 20 多年创新实战经验, 3000 多款经典作品成功上市, 以“用户至上、协同创新”的合作理念, 与客户一起共同打造行业领先品牌。

**主要展品 /Products**

工业设计、外观设计、结构设计、原理研发、品牌设计、营销策划、平面设计、包装设计、推广设计

**广东顺德锐铂汇电子科技有限公司****GUANGDONG SHUNDE RAINBOW WAY TECHNICAL CO., LTD.****E2-2A05**

地址：广东省佛山市顺德区黄龙村龙涌大道46号之九(528311)

Add: 46 Longchong Road, Huanglong Village, Beijiao Town, Shunde District, Foshan City, Guangdong, China.

电话 /Tel: 0757-29993071

传真 /Fax: 0757-29993078

网址 /Web: www.rbwaircooler.com

广东顺德锐铂汇电子科技有限公司, 主营: 产品设计、结构设计, 工业产品模型、模具设计, 平面展示设计、广告设计, 电脑动画设计、包装装潢设计服务; 工艺美术创作、影视策划、市场营销策划咨询、翻译服务; 电子, 电器产品研发。我们团队设计的产品畅销全球30多个国家和地区, 为一线消费者带去健康方便舒适的生活用品的同时, 也可为您提供个性化服务。欢迎您详细了解我们的设计团队, 我们愿意和您一道实现您的最新IDEA。

The company's main business is product design, structural design, industrial product model, mold design, graphic display design, advertising design, computer animation design, packaging design services; Arts and crafts creation, film and television planning, marketing planning consulting, translation services; Research and development of electronic and electrical products; The company design team not only has experienced industrial appearance designer team, but also gathered a number of structural design engineers with actual operation experience. What is more interesting to you is the outstanding young designers who graduated this year. The products designed by our team are hot-sale in more than 30 countries and regions around the world. We can not only bring healthy, convenient and comfortable daily necessities to consumers, but also provide personalized services for you. Welcome to know more about our design team, we are willing to work with you to realize your latest IDEA

**主要展品 /Products**

家用冷风扇, 工业用冷风扇, 空气净化器, 加湿器, 直流风扇, 电暖器

Household air cooler, commercial air cooler, air purifier, humidifier, DC fan, fan heater.

**瑞利洁****广东顺德瑞利洁环境科技有限公司****Guangdong Shunde ruilijie Environmental Technology Co., Ltd****E1-1A06**

地址: 佛山市顺德区北滘镇盛国高新产业园 C1 栋 6 楼

Add: 6/f, building C 1, Shengguo high-tech industrial park, Beijiao, Shunde District, Foshan City

电话 /Tel: 13360362260

传真 /Fax: 0757-22397418

网址 /Web: www.gdrj.net

研发 制造 销售空气过滤器 初中高效过滤器

Research and development, manufacture, sales of air filter high efficiency filter junior high school

**主要展品 /Products**

初效滤网 HEPA 滤网 活性炭滤网 光触媒滤网

Primary Filter HEPA filter, activated carbon filter, photocatalyst filter

**Sleek****广东思利科智能科技有限公司****Guangdong Sleek Intelligent Technology Co., Ltd.****N4-4B22 4B23**

地址: 广东省佛山市顺德区容桂街道华口社区昌宝东路一横路1号(528306)

Add: NO.1 YIHENG ROAD, CHANGBAO EAST ROAD, HUAKOU, RONGGUI, SHUNDE FOSHAN CITY, GUANGDONG PROVINCE, CHINA

电话 /Tel: 0757-29212274

传真 /Fax: 0757-29212487

网址 /Web: http://www.sleekchina.com

专业从事国内外厨电产品研发、制造、销售二十多年。特别是对燃气灶具系列产品的研发、制造、代工业务方面独树一帜, 是厨电行业的佼佼者。公司具备二十多年的产品技术积淀, 其产品档次较高, 具备独特的产品体系。特别是燃气灶具拥有“三引三控三环火”、“九冲程五环圣火”、“自锁自控梅花火”、“三环四驱燃烧器”等多项燃气灶具专利技术, 在行业里多处于领先地位, 在灶具行业里, 也多为大型的厨卫企业进行 OEM。

Guangdong sleek Intelligent Technology Co., Ltd. is a private enterprise specializing in the R & D, manufacturing and sales of kitchen electrical products at home and abroad for more than 20 years. Especially in the R & D, manufacturing and OEM business of gas stove series products, it is a leader in the kitchen electricity industry. The company has more than 20 years of product technology accumulation, with high-grade products and unique product system.

**主要展品 /Products**

燃气灶具

gas hob

**广东思诺得环保科技有限公司**  
**Guangdong Cinotex Environmental Sci-Tech Co., Ltd.****W2-2D71**

地址: 广东省中山市东升镇裕隆 3 路 122 号 A 栋 5 楼 (528414)

Add: 5th floor, Building A, 122 Yulong Third Road, Dongsheng town, Zhongshan, Guangdong Province

电话 /Tel: 0760-22217335

传真 /Fax: 0760-22217602

网址 /Web: <https://gdsnd.en.alibaba.com>

广东思诺得环保科技有限公司创建于 2016 年, 是一家集产品研发、生产、销售为一体的高新技术、省市专精特新、科技型、创新型企业, 产品主要是空气净化器, 加湿器, 解冻器, 果蔬机, 加湿净化器, 应急棒等家电产品, 拥有 20 项发明专利, 60 项实用新型专利, 20 多项外观专利, 产品畅销全球多个国家和地区。

Founded in 2016, factory covers 20000 square metres area (have production workshop and quality testing equipment) employs over 600 people, have 20 invention patents, 60 practical new patents, 20 appearance patents.

**主要展品 /Products**

空气净化器, 新风机, 加湿器, 加湿 + 空气净化 2 合 1, 果蔬清洁剂, 肉类解冻器, 智能垃圾桶, 应急棒。  
Air purifier, Fresh Air ventilator, humidifier, humidifier+air purifier 2 in 1, fruit&vegetable washing machine, household defrosting machine, smart trash can, emergency rod.

**广东四季福燃气具有限公司****N1-1A19**

地址: 广东省中山市黄圃镇大雁工业区神飞路 8 号

电话 /Tel: 18680167529

广东四季福燃气具有限公司位于誉有“中国小家电之都”的珠江三角洲中山市, 公司现有 20000 多平方米的现代化生产厂房, 拥有雄厚的五金冲压实力和配备日本先进检测设备的一流燃气热水器总装线。公司总投资 8000 多万元, 已形成年生产恒温燃气热水器 50 多万台。并以优异的成绩取得家用燃气热水器的 3C 认证。公司以严格的管理, 先进的技术和优良的品质, 为各品牌企业提供优质 ODM 产品, 发展成为燃气具行业名牌的生产基地。

**主要展品 /Products**

燃气热水器整机, 燃气灶具整机, 热交换器, 燃烧器及外壳五金件

**威派尔 (广东) 电器科技有限公司**  
**Wipfel (Guangdong) Electrical Technology Co., LTD****N3-3B22**

地址: 广东省江门市鹤山市古劳镇三连工业区 3-28 号 (529700)

Add: No. 28-3, Zone 2, Sanlian Industrial Zone, Gulao Town, Heshan City, Jiangmen City, Guangdong, China

电话 /Tel: 0750-89922090

网址 /Web: <https://www.willpowergd.com/>

威派尔 (广东) 电器科技有限公司成立于 2021-06-15, 主要研发生产销售为一体的智能厨房小家电烤箱破壁机 果汁机豆浆机 封口机等。

Weipell (Guangdong) Electrical Technology Co., LTD was established in 2021-06-15, mainly research and development, production and sales of smart kitchen small household appliances oven wall breaking machine juice machine soy milk machine sealing machine, etc.

**主要展品 /Products**

智能厨房小家电烤箱破壁机 果汁机豆浆机 封口机等 ;

Smart kitchen small household appliances oven wall breaking machine juice machine soy milk machine sealing machine and so on;

**天际 TONZE****广东天际健康电器有限公司**  
**Guangdong TONZE Health Electric Appliance Co., LTD****N3-3H71**

地址: 广东省佛山市顺德区大良街道智诚路 3 号南方智谷 23 楼 (528000)

Add: 3 Zhicheng Road, Daliang Street, Shunde District, Foshan city, Guangdong Province, China

电话 /Tel: 0754-88118888

传真 /Fax: 0754-88139999

网址 /Web: [www.tonze.com](http://www.tonze.com)

广东天际电器股份有限公司, 1996 年创始, 2015 年 A 股上市, 是集研产销为一体的现代化企业, 以弘扬“食尚”文化, 创造精致生活与铸就健康人生为己任, 致力于养生小家电的研发与创新, 争创中国养生小家电标杆品牌。

2016 年, 布局产业多元化战略, 并购江苏新泰材料科技有限公司, 挖掘新能源产业潜力, 谋求企业新增长, 构建集陶瓷制造、家用电器、新能源、电子医疗器械等全面发展企业新体系。

Guangdong Tonze Electric Co., Ltd., founded in 1996, went public in 2015, is a modern enterprise integrating research, production and marketing. With the mission of carrying forward "food fashion" culture, creating exquisite life and forging a healthy life, Guangdong Tonze Electric Co., Ltd. is committed to the research and development and innovation of health small household appliances, striving to become the benchmark brand of health small household appliances in China.

In 2016, we laid out the industrial diversification strategy, acquired Jiangsu Xintai Material



Technology Co., LTD., tapped the potential of the new energy industry, sought new growth of the enterprise, and established a new enterprise system integrating ceramic manufacturing, household appliances, new energy, electronic medical equipment and other comprehensive development.

#### 主要展品 /Products

陶瓷内胆电炖锅、陶瓷内胆隔水炖、陶瓷内胆电饭煲、陶瓷养生煲、玻璃养生壶、电热水壶、电水瓶、多功能料理机、绞肉机

Ceramic liner electric stew pot, ceramic liner water-proof stew, ceramic liner electric rice cooker, ceramic health preservation pot, glass health preservation pot, electric kettle, electric water bottle, multi-functional cooking machine, meat grinder

## TIJUMP 天骏

### 广东天骏智能科技有限公司

W5-5B32 5B33 5B34 5B35

#### Guangdong Tijump Intelligent Technology Appliance co., LTD

地址: 广东省中山市小榄镇联丰广东中心路 27 号 (528400)

Add: 27 Lianfeng Guangle Central Road, Xiaolan Town, Zhongshan City, Guangdong Province

电话 /Tel: 13590908044

网址 /Web: <http://www.zstj.com/>

广东天骏是一家从事智能家居电器研发、生产、销售的企业, 是全球首家研发烘干机公司。公司成立于 2006 年, 主营干衣机、智能衣物护理机、干衣盒、干身器等智能家电设计、研发、生产销售为一体, 采用线上线下新销售模式, 年产值超 100 万台, < 天骏 > 品牌在干衣机产品稳居国内淘宝、京东销售品牌第一名; 主要合作伙伴是美的、艾美特等国内知名品牌已构成长期合作关系; 海外市场已构建了英国、韩国、日本等海外销售渠道。

Guangdong Tianjun is a company engaged in the research and development, production and sales of smart home appliances, is the world's first research and development dryer company. The company was founded in 2006, mainly engaged in the design, research and development, production and sales of intelligent household appliances such as clothes dryers, smart clothes care machines, clothes boxes and body dryers. It adopts the new sales model online and offline, with an annual output value of more than 1 million units. The < Tianjun > brand ranked the first place in domestic Taobao and Jingdong sales brand in clothes dryers. Main partners are Midea, Emmett and other domestic well-known brands have formed long-term cooperative relations; Overseas market has established the UK, South Korea, Japan and other overseas sales channels.

#### 主要展品 /Products

干衣机、智能衣物护理机、干衣盒、干身器等智能家电。

Intelligent household appliances such as clothes dryer, intelligent clothing care machine, clothes dryer box and body dryer.

## Flexwarm 飞乐思

### 广东天物新材料科技有限公司

W5-5A36

地址: 广州市番禺区沙湾镇紫坭村西安路 7 号飞乐思总部

电话 /Tel: 400-005-6565

网址 /Web: [www.flexwarm.com](http://www.flexwarm.com)

飞乐思是天物集团旗下个护健康品牌。夯实的技术确保产品过硬品质, 为用户提供前所未有的优质体验。

公司注重技术投入与开发, 目前设有无人自动化工厂、全球认证的 iTS 认可实验室、-70°C 极限低温模拟实验室等, 目前在全球范围内已拥有超过 200+ 专利技术布局。

秉承“精准、安全”的理念, 飞乐思的产品涉及智能穿戴、小家电、智能家纺、供暖等行业。飞乐思品牌致力于成为个护健康领域的引领者。

#### 主要展品 /Products

智能穿戴产品、小家电产品、智能家纺产品、电供暖产品

## 天洋电机 Tianyang

### 广东天洋电机有限公司

W3-3B37

地址: 佛山市南海区狮山镇谭边工业区长格良岗 3 号

电话 /Tel: 13827084298

网址 /Web: [www.tymotor.net](http://www.tymotor.net)

广东天洋电机有限公司成立于 1991 年, 建立区级三相异步电动机工程技术研究中心, 获得多项发明, 实用新型和软件注册专利, 荣获国家高新技术企业、广东省专精特新技术企业称号。公司提供技术开发及支持特殊定制, 建立了完善的品质控制系统, 已通过 ISO9001:2018 质量管理体系认证, 产品通过国家强制产品 CCC 认证、CE 认证等相关行业认证, 符合 G812350-2009 等国内和行业标准。

#### 主要展品 /Products

家用吹风机 12 万转电机、家用吸尘器 8 万转电机、吹风机

## TIMZUU

Kitchen Appliances

### 广东天倬智能家居有限公司

E2-2C41

#### Guangdong Timzuu Electric Appliances Co.,Ltd

地址: 广东省东莞市横沥镇桃子园高新产业园 (523460)

Add: Taoziyuan High-tech Industrial Park, Hengli Town, Dongguan City, Guangdong Province

电话 /Tel: 15920635706

传真 /Fax: 0769-88973969

网址 /Web: [www.timzuu.com](http://www.timzuu.com)

广东天倬智能家居有限公司成立于 2010 年, 专注于蒸汽烤箱的研发制造, 是国内最早涉足该类产品研发制造的企业之一, 目前, 天倬蒸汽烤箱素以定位高端、品质稳定、技术创新赢取市场, 公司成为中国蒸汽烤箱 OEM/ODM 知名企业。并在该领域积累了 60 多项专利技术。如今, 天倬智能是国内拥有蒸汽烤箱平台多, 拥有大量国内外知名厨电 OEM 客户的企业, 我们会持续在蒸烤一体机、微蒸烤一

体机领域深耕。

In 2010, Guangdong Timzoo Electric Appliances Co., Ltd. established, focus on research and development of steam ovens kitchen electrical products, became one of the first companies to get involved in the development of steam oven products. At present, with first-mover advantage, Timzoo's development momentum is good. The high-end, stable quality and technological innovation of Timzoo steam oven products have been recognized by the market; Timzoo has become the best OEM/ODM partner of steam oven in China. Have accumulated more than 60 technical patents in this field. Today, in China, TIMZOO has the largest series of steam oven models, and has the largest number of well-known brand customers home and abroad in OEM cooperation. Facing the trillion-level global market, we will continue to deepen our efforts in the field of steam oven and micro-steam oven etc. Meanwhile, we will invest in research and development of innovative small home appliances.

#### 主要展品 /Products

目前公司有多个蒸烤箱 / 微蒸烤箱平台, 台式蒸汽烤箱、台嵌两用蒸汽烤箱、嵌入式蒸汽烤箱、台式微蒸烤箱、嵌入式微蒸烤箱、吊柜式蒸烤箱, 多种升数, 不同大小, 满足家庭的使用需求。

At present, the company has multiple steam oven/micro steam oven platforms, desktop steam oven, table-mounted dual-purpose steam oven, built-in steam oven, desktop micro-steam oven, built-in micro-steam oven, wall cabinet type steam oven, various liters, Different sizes to meet the needs of families.



#### 广东万和新电气股份有限公司

N2-2C21

#### GUANGDONG VANWARD NEW ELECTRIC CO.,LTD

地址: 广东省佛山市顺德高新区(容桂) 建业中路 13 号 (528305)

Add: No.13, Jianye Mid-Road, Shunde High-Tech Industry Development Zone, Ronggui, Shunde, Foshan, Guangdong, China

电话 /Tel: 0757-28898888

传真 /Fax: 0757-23617088

网址 /Web: <https://www.vanward.com/>

万和是国内 A 股上市公司, 股票代码 002543, 公司成立于 1993 年 8 月, 已发展成为国内热水器、厨房电器、热水系统专业制造先进企业。

万和燃气热水器市场占有率连续十八年位居行业首位, 燃气灶、吸油烟机、电热水器的市场占有率均处于行业前列。万和在厨卫电器领域拥有 50 多项行业领先技术, 90 多次主导或参与了燃气热水器、燃气灶具、消毒柜国家和行业标准的起草和修订, 拥有 2300 多项专利。

#### 主要展品 /Products

燃气热水器、电热水器、燃气采暖热水炉、吸油烟机、燃气灶、消毒柜、蒸烤箱、洗碗机、集成灶、多能源热水系统

## 万家乐

#### 广东万家乐燃气具有限公司

N2-2F41

#### GUANGDONG MACRO GAS APPLIANCE CO.,LTD.

地址: 广东省佛山市顺德区大良街道五沙社区顺园南路 9 号 (582300)

Add: Shunyuan South Road #9, Wusha Community, Daliang Street, Foshan City, Guangdong Province, P.R.China

电话 /Tel: 0757-22813999

传真 /Fax: 0757-22813999

网址 /Web: <https://www.chinamacro.cn>

万家乐始于 1985 年, 专注于改善中国家庭热水和厨房生活, 产品包括热水器、油烟机、燃气灶、净水器、洗碗机、壁挂炉等, 以“全球亿万家庭美好厨卫生活创造者”为愿景, 致力为用户打造品质、快乐、美好的生活。

作为国家重点高新技术企业和国家认定企业技术中心, 万家乐拥有博士后科研工作站和国家认可实验室, 研发 2500 多项专利, 荣获 3000 项国内外大奖, 参与制定 104 项国家、行业标准, 引领厨卫行业升级进程。

Founded in Year 1985, Macro has been focus on improving hot water and kitchen life for Chinese Families by researching and developing water heaters, ranger hood, gas stoves, water purifiers, dish washers, and gas boilers etc., devoted into creating high quality, happy and amazing life for users.

As a National High-tech Enterprise and National Recognized Enterprise Technology Center, Macro owns Post-Doctoral Programme and National Recognized laboratory, developing innovative technologies such as small-volume integrated technology, zero cold water technology, household central hot water proposal, non-electric washing technology, and automatic cooking kitchen and so on. In the past 36 years, Macro has led 10 groundbreaking technological innovations in the industry, owned more than 2500 patents, led or participated in the formulation of 104 national and industrial standards, and gained nearly 3000 authoritative industry awards at home and abroad.

#### 主要展品 /Products

家用中央热水燃气热水器、零冷水燃气热水器、无电洗电热水器、速热电热水器、爆炒风变频油烟机、双高火燃气灶、嵌入式洗碗机、水槽洗碗机、消毒柜、蒸烤箱、电烤箱、电蒸箱、集成灶、厨下纯水机、零冷水壁挂炉、全预混壁挂炉



#### 广东维普电器有限公司

N4-4A38

#### Well Precision Inc.(USA)

地址: 广东省东莞市常平镇还珠沥 151 号 501

电话 /Tel: 076981032686

广东维普电器有限公司, 专注于美式全尺寸衣物烘干机的制造。由美国 well Precision Inc.(USA) 授权生产 Rafodo(来福兔) 品牌的 210 升内筒, 载重 16KG 的美式烘干机。该款烘干机的烘干效果能完全实现衣物不需晾晒的功能, 衣物烘干后平顺柔软蓬松。还能全方位对应床单被套和被子的烘干, 有杀菌杀螨虫去尘的作用, 与干洗效果无异。美国来福兔烘干机, 将成为中国家庭的最后一个必备大家电。



#### 主要展品 / Products

美国全尺寸智能滚筒衣物烘干机

American Style Full Size Intelligent Tumbler Clothes Dryer (704CFT)



#### 广东祥基电器有限公司

**N1-1A17 1A18**

地址: 广东省中山市东凤镇同乐工业园 (528425)

电话 /Tel: 0760-22603868

传真 /Fax: 0760-22603928

网址 /Web: www.zsxj.com

广东祥基电器有限公司是燃气热水器燃烧系统、热交换系统及整机研发制造基地, 成立 30 多年来专注于燃气热水器核心部件及整机的创新研发及精益制造。祥基研发中心拥有气源成份配比及分析仪器、水质成份配比及分析仪器、步入式高 / 低温环境温度实验室、整机性能实验室、整机寿命实验室、零部件型式试验室、电控实验室、噪音实验室等行业领先实验设施。

#### 主要展品 / Products

燃气热水器、家用燃气灶具、电器及其配件、燃气具及其配件

xoJiang 小将

#### 广东小将电子技术有限公司

**N2-2B26**

**Guangdong Xiaojiang Technology Co., Ltd.**

地址: 广东省中山市东凤镇同安大道西 54 号扬子工业园二楼小将电器

电话 /Tel: 13924979743

广东小将电子技术有限公司是一家从事电子专用材料研发, 能源技术研发, 互联网数据服务等业务的公司, 成立于 2016 年 07 月 13 日。家用电器研发; 家用电器制造; 家用电器销售; 非电力家用器具制造; 非电力家用器具销售; 燃气器具生产; 厨具用具及日用杂品研发; 五金产品制造; 五金产品零售; 塑料制品制造; 塑料制品销售; 模具制造。

#### 主要展品 / Products

台式消毒柜



#### 广东新宝电器股份有限公司

**N3-3F41**

**Guangdong Xinbao Electrical Appliances Holdings Co., Ltd**

地址: 广东省佛山市顺德区勒流镇广东新宝电器股份有限公司 (总部) (528322)

Add: Guangdong Xinbao Electric Appliance Co., Ltd. (Headquarters), Leliu Town, Shunde District, Foshan City, Guangdong Province

电话 /Tel: 0757-25333888

传真 /Fax: (86)757-2533-3888

网址 /Web: www.donlim.com

广东新宝电器股份有限公司为 A 股上市公司始创于 1995 年, 是专注于厨房电器、家居护理电器、婴儿电器、制冷电器、个护美容电器、智能家电和电器配件等覆盖全类目小家电产品的制造企业。新宝股份始终专注于全球小家电市场, 产品主要出口到欧洲、美洲、澳洲等全球 100 多个国家和地区。新宝股份拥有强大的自主研发及创新设计能力, 先后被认定为国家企业技术中心和国家级工业设计中心。

Guangdong Xinbao Electric Appliance Co., Ltd. is A-share listed company (Stock Code: 002705), founded in 1995, is a manufacturing enterprise focusing on kitchen appliances, home care appliances, baby appliances, refrigeration appliances, personal care and beauty appliances, smart appliances and electrical accessories covering a wide range of small household appliances. Xinbao has always focused on the global small household appliance market, and its products are mainly exported to more than 100 countries and regions in the world, such as Europe, America and Australia Area. The company has a plant area of more than 1 million square meters and more than 28000 employees. Xinbao Co., Ltd. has strong independent R & D and innovative design capabilities, and has been recognized as "national enterprise technology center" and "national industrial design center"; And passed ISO9001, QC080000, ISO14001 and OHSAS18001 system certification.

#### 主要展品 / Products

生产经营电蒸汽熨斗、搅拌机、咖啡壶、开水器、面包机、电动牙刷、冲牙器、牙齿美白器、消毒器、充电器、口腔护理类产品、按摩器、家用美容美体类仪器、家用理疗护理类仪器、家用美发造型类仪器等家用电器产品。

Production and operation of electric steam iron, mixer, coffee pot, water boiler, bread maker, electric toothbrush, tooth flushing device, tooth whitening device, sterilizer, charger, oral care products, massager, household beauty and body care instruments, household physiotherapy and nursing instruments, household hairdressing and modeling instruments and other household electrical appliances.



#### 广东新纬电器有限公司

**E3-3A21**

**Guangdong Newway Electric Appliance Co., Ltd.**

地址: 揭阳空港经济区凤美街道塘埔村七支渠南片 (522021)

Add: South Section of Qizhiqiu, Tangpu Village, Fengmei Street, Airport Economic Zone, Jieyang City, Guangdong Province, China

电话 /Tel: 0663-8322555

传真 /Fax: 0086-663-8322555

<https://newwayelec.en.alibaba.com/minisiteentrance.html?spm=a2700.details.cordpanyb.2.461a7925ZwNDKV&from=detail&productid=1600366053684>

广东新纬电器有限公司成立于 2021 年 08 月 24 日, 经营范围包括一般项目: 家用电器制造, 销售与安装服务; 日用家电零售; 照明器具制造与销售; 其他电子器件制造; 电子元件制造与批发; 电动机制造; 电气设备销售; 五金产品制造与批发; 塑料制品制造与销售; 模具制造与销售; 机械设备研发与租赁; 机械零件、零部件销售; 美发饰品生产与销售; 国内贸易代理; 互联网销售 (除销售需要许可的商品); 货物进出口; 技术进出口。

Guangdong Xinwei Electric Appliance Co., Ltd. was established on August 24, 2021. Its business scope includes general items: household appliances manufacturing, sales and installation services; Retail of household appliances; Lighting equipment manufacturing and marketing; Manufacturing of other electronic devices; Electronic components manufacturing and wholesale; Motor manufacturing; Electrical equipment sales; Hardware products manufacturing and wholesale; Plastic products manufacturing and marketing; Mold manufacturing and sales; Mechanical equipment research and development and leasing; Machinery parts, spare parts sales; Hairdressing accessories production and marketing; Domestic trade agency; Internet sales (except sales of licensed goods); Import and export of goods; Technology import and export.

#### 主要展品 /Products

电吹风, 卷发棒, 直发器  
hair dryer, hair curler, hair straightner



#### 广东雄润电业有限公司

#### Guangdong Xiongrun Electrical Co., Ltd.

W2-2B32

地址: 广东省佛山市顺德区大良街道五沙新辉路 10 号 (528333)

Add: No.10, Xinhui Road, Wusha, Daliang, Shunde District, Foshan City, Guangdong Province, China

电话 /Tel: 0757-22293333

传真 /Fax: 0757-22290333

网址 /Web: <http://www.xiongrun.com>

广东雄润电业有限公司 (佛山市顺德区南加美电业科技有限公司) 创建于 1992 年, 厂房面积 27, 000 平方米。专业生产插头, 电源线, 延长线, 线束及各类电子线。通过 ISO9001:2015 及 ISO14001:2015 国际体系认证, 产品有 CCC, UL/CUL, SAA, ASTA, VDE, KC, PSE, BSMI, SASO, IRAM, KEMA, CB, PSB 等国际认证及 RoHS, REACH 和加州 65 环保认证。

We specialize in producing international standard power supply cords, extension cord sets, wiring harnesses and electronic wire. The company have ISO9001:2015 Quality System Certification and ISO14001:2015. All products are complied with: CCC, UL/CUL, CSA, SAA, ASTA, VDE, KEMA, KC, PSE-Mark, BR1852, KEMA, BSMI, CB, SASO, IRAM, IS 1293-2005, PSB, SEV6534-2 etc. and ROHS & REACH certificates. Under principle of good quality, punctual shipment & competitive price, we serve customers with an annual output of 80 million.

Now we have long-term and stable customer group, our products are exported to the countries of America, Europe, Australia and Southeast Asia, Our products always are sold well all over the world customers' satisfaction is our tenet which will never alter, with better quality product and more faithful service; we would like to cooperate with every customer for a bright future! Welcome!

#### 主要展品 /Products

插头, 电源线, 延长线, 线束及各类电子线  
power supply cords, extension cord sets, wiring harnesses and electronic wire

## YALICE 雅丽诗

### 广东雅丽诗电器股份有限公司

N2-2H81

#### YALICE

地址: 广东省中山市黄圃镇马新工业区盛业南路 3 号 (528429)

Add: No. 3, Shengye South Road, Maxin Industrial Zone, Huangpu Town, Zhongshan City, Guangdong Province

电话 /Tel: 400-030-0230

传真 /Fax: 760-23972613

网址 /Web: <http://www.yalice-china.com/>

广东雅丽诗电器股份有限公司成立于 2000 年, 本公司一次性通过 SGS 国际认证集团“中国认证供应商”审核, 产品获得 CE、CB、EMC、CCC 等多项国内国际权威认证及技术专利, 并通过 ISO9001-2008 国际质量管理体系认证。公司引进行业领先热水器自动化生产系统, 包括内胆搪瓷线、内胆焊接机器人、内胆试压检测装备、多头太空仓式高压发泡机、电阻式外壳一次成形设备等, 是掌握厨卫电器核心科技的全球化企业之一。

Guangdong YALICE Electric Appliance Co., Ltd. was established in 2000. The company passed the "China Certified Supplier" audit of SGS International Certification Group at one time. Its products have obtained multiple domestic and international authoritative certifications and technical patents such as CE, CB, EMC, CCC, and passed the ISO9001-2008 international quality management system certification. The company has introduced industry-leading automatic production systems for water heaters, including liner enamel lines, liner welding robots, liner pressure testing and testing equipment, multiple space chamber high-pressure foaming machines, and resistive shell one-time forming equipment. It is one of the global enterprises that master the core technology of kitchen and bathroom appliances.

#### 主要展品 /Products

光伏电热水器、圆筒式电热水器、扁筒式电热水器、立式电热水器、小厨宝、燃气热水器、燃气灶、吸油烟机、洗碗机、电吹风。

Photovoltaic electric water heaters, cylindrical electric water heaters, flat cylindrical electric water heaters, vertical electric water heaters, kitchenware, gas water heaters, gas stoves, range hoods, dishwashers, hair dryers.

ACE-TEC  
SMART BEAUTY

### 广东雅思电子有限公司

E3-3C66

#### Guangdong Ace-Tec Co., Ltd

地址: 东莞市寮步镇西溪工业区金兴路 420 号 (523400)

Add: No.420, Jinxing Road, Xixi Industrial Park, Liaobu Town, Dongguan, Guangdong, China.

电话 /Tel: 0769-83016780

传真 /Fax: 0769-83016790

网址 /Web: [www.ace-tec.com](http://www.ace-tec.com)

Ace-tec Co. Ltd 成立于 2003 年, 是一家专注于家用美容保健设备研发和制造的国家高新技术企业。凭借卓越的研发和制造能力, Ace-Tec 已成为越来越多国际顶级品牌的战略合作伙伴, 产品远销日本、韩国、欧美等国家。依托不断提升的研发能力和全链条制造能力, Ace-Tec 致力于为客户提供 ODM/OEM 定制服务。



Founded in 2003, Ace-tec Co. Ltd is a National High-tech enterprise focusing on the development and manufacturing of home beauty and healthcare devices. Based on excellent R&D and manufacturing ability, Ace-Tec has become a strategic partner with more and more international top brands, with products exported to Japan, South Korea, Europe, and America. Relying on continuously improved R&D ability and full chain manufacturing ability, Ace-Tec is committed to providing ODM/OEM customized services to customers in multiple application fields.

#### 主要展品 /Products

洁面仪, 美容仪, 脱毛仪, 电动牙刷, LED 面罩, 射频仪, 纤体仪, 按摩仪  
Facial cleansing brush, Beauty devices, IPL Hair Removal, Electric Toothbrush, LED Mask, RF devices, Slimming body devices, Body massger devices.



#### 广东易得电器有限公司

##### Guangdong Yide Electric Appliance Co., Ltd.

地址: 广东省佛山市顺德区勒流镇众涌众裕北路 1 号 (528322)

Add: No.1 North Road Zhongyu, Leliu, Shunde, Guangdong, CHINA

电话 /Tel: 0757-25568081

传真 /Fax: 0757-25538000

网址 /Web: www.yideco.com

广东易得电器有限公司, 成立于 2004 年, 坐落于美丽的工业城市广东顺德, 占地面积 50000 平方米, 是一家自主研发、生产、销售小家电产品的制造企业。主要产品有: 咖啡壶、打蛋机、搅拌机、榨汁机等小家电及大家电洗碗机, 年产量 350 万台, 产品获得 30 多项发明和实用专利, 产品通过 GS、CE、CB、UL、ETL、CETL、FDA、LFBG、ROHS 等多项国际权威认证。

GUANGDONG YIDE ELECTRIC APPLIANCE CO., LTD. was established in 2004, located in the beautiful industrial city of Guangdong Shunde, covering an area of 50,000 square meters. It is a manufacturing enterprise specializing in R&D, production and sales of small household electrical appliances and major appliances such as coffee maker, mixer, blender, juicer and dishwasher etc. The annual output has come to over 3.5 million units. The products have obtained more than 30 inventions and practical patents. The products have passed many international authoritative certifications such as GS, CE, CB, UL, ETL, CETL, FDA, LFBG, ROHS, etc.

#### 主要展品 /Products

洗碗机、咖啡机、磨豆机、打蛋机、搅拌机、破壁机、榨汁机、绞肉机、碎肉机  
Dishwasher, Coffee maker, Hand mixer, Blender, Wall-breaking Food Machine, Meat grinder, Chopper

N1-1A12



#### 广东英为拓科技有限公司

##### Guangdong Invitop Technology Co., Ltd.

地址: 广东省中山市三角镇金三大道东 8 号民森信息产业园 AB 区 (528445)

Add: 3F, Area A1, Minsen Information Technology Industrial Park, No.8, East of Jinsan Avenue, Sanjiao Town, Zhongshan City, Guangdong Province

电话 /Tel: 0760-85409890

传真 /Fax: 0760-85409890

网址 /Web: www.invitop.com

W2-2E71

广东英为拓科技有限公司是一家成立于 2011 年专注于家电美学的科技创新型企业, 坐落于粤港澳大湾区中心地带中山市。目前拥有 600 职员, 3 万平生产车间, 9 条自动化生产线, 实现年产能 600 万台, 2022 年销售额达到 9 亿人民币。

英为拓, 以产品研发为主, 坚持原创设计, 并将产品细节做到极致, 产品涵盖环境、厨房和制冷家电。公司自主培养一支极具研发攻关能力的 120 人团队, 可满足客户各种 OEM 家电产品开发需求。

Guangdong Invitop Technology Co., Ltd. is a technologically innovative enterprise focusing on home appliance aesthetics. Invitop is established in 2011 and located in Zhongshan City, the central area of the "Guangdong-Hong Kong-Macao Greater Bay Area", a national strategic development center.

Our company currently owns a staff volume of 600, a production workshop area of 30 thousand square meters, and 9 Automatic production lines. And we perfectly guarantees an annual capacity of 6 million units and a sales volume of RMB 900 million in 2022.

INVITOP focuses on product research and development, insists on original design, and takes product details to the extreme. Our products research covers Environment, Kitchen and Refrigeration appliances.

INVITOP has independently cultivated a team of 120 people with great research and development capabilities, which can meet the development needs of customers for various OEM home appliances.

#### 主要展品 /Products

环境家电: 空气净化器、除湿机、加湿器、暖风机、冷风机、无叶风扇

制冷家电: 制冰机、移动空调、除湿机

厨房家电: 空气烤箱 / 蒸汽烤箱、无烟烧烤、低温慢煮机、厨师机、真空储物桶, 真空封口机, 冰淇淋机

宠物电器: 宠物理毛器、宠物饮水机、宠物储粮桶

- ① Air Appliances: Air Purifier, Dehumidifier, Humidifier, Fan Heater, Air Cooler, Bladeless Fan
- ② Refrigeration Appliances: Ice Maker, Portable Air Conditioner, Dehumidifier
- ③ Kitchen Appliances: Air Fryer Oven/Steam Oven, Smokeless barbecue, Sous Vide, Stand Mixer, Vacuum Rice Bin, Vacuum Sealer, Ice Cream Maker
- ④ Pet Appliances: Pet Grooming Kit, water dispenser, Pet Food Storage bin



广东永衡良品科技有限公司

Zhongshan Yeshm Commodities Co., Ltd.

地址: 广东省中山市火炬开发区大岭工业区 1 号 (528437)

电话 /Tel: 0760-23767777

网址 /Web: www.yeshm.com

广东永衡良品科技有限公司创立于 2004 年, 位于广东省中山市, 是一家集设计、研发、生产、销售为一体的家用衡器企业。拥有自己的产品研发室和实验室, 在产品设计上寻求创新, 拥有国内外专利近 100 项。永衡良品旗下拥有多个品牌, 产品出口欧盟、美国、韩国、日本等多个海外国家及地区, 深受国内和国外市场的认可。

Zhongshan YESHM Commodities Co., Ltd. was found in 2004 which was located in Zhongshan City, Guangdong Province. It is a home weighing enterprise that integrating Design, Research and Development, Production and Sales. Products include Human Health Scales, Kitchen Scales, Body Fat Scales, Bluetooth Scales, Luggage Scales, Timers, etc. YESHM has its own product development room and laboratory. We have focused on the development and production of household scales, focusing on product design and user experience.

#### 主要展品 /Products

主要产品: 电子人体秤、智能体脂秤、自发电体重秤、按摩人体秤、电子烘焙秤、行李秤等。

Main products: Electronic body scale, Smart scale, Battery Free bathroom scale, Massage scale, Electronic kitchen scale, Luggage scale, etc.



广东长锦成智能制造有限公司

Guangdong ChangJinCheng Tech Co.,LTD

地址: 广东省东莞市大岭山镇马蹄岗沙井头十一巷 3 号 201 室 (523810)

Add: Room 201, No.3, Lane 11, Shajingtou, Matigang, Dalingshan Town, Dongguan,

Guangdong Province

电话 /Tel: 18676729386

网址 /Web: www.cjcmotor.com

长锦成成立于 1997 年, 是一家集电机, 橡胶制品和五金制品等部件的研发和制造于一体的综合性企业, 主要服务于家电行业、家居行业、汽车行业、电子行业、物流仓储行业、机械设备及金融设备 ATM 等领域。

公司产业布局于深圳, 东莞和湖南永州, 从配件到成品, 实现垂直一站集成式电机与橡胶全产业链。

公司拥有 100 多项的专利, 可以实现电机电控集成设计, 为客户实现从电磁仿真电路仿真到结构设计到电机交付的一站式交付。

Found in 1997, Changjin Cheng Electrical Appliances Co., LTD, hereafter, abbreviated as CJC, is a large scale of industrial enterprise integrating the R&D and manufacturing of motors, rubber products and hardware products. We serve a broad range of industries including home appliances, home furnishing, automobile, electronics, logistics, warehousing, mechanical equipment and financial equipment ATM etc.

CJC's vertically integrated manufacturing system can extensively offer fast small batch production

N2-2A40

N3-3B51 52

for both motor and rubber industry. From accessories to finished products, CJC delivers vertical one-stop service for the entire motor and rubber industry chain.

CJC products are protected by more than 100 patents covering all areas of control, mechanical parts, motor design, appliances, material processing and etc., the aim is to be a one-stop deliver from electromagnetic simulation circuit simulation to structural design to final product.

#### 主要展品 /Products

厨房小电类有刷电机、破壁机电机、咖啡机电机、家用机器人电机、风扇 & 空气净化器电机、风机类电机、串激马达、永磁直流马达、无刷直流马达、减速马达等

small kitchen appliances brushed motors, blender motors, coffee maker motors, home robot motors, fan&purifier motors, fan motors, universal AC motors, PMDC motors, BLDC motors, gear reduction motors



广东中宝温控科技股份有限公司

Guangdong Zhongbao Thermostat Technology Co., Ltd.

地址: 广东省佛山市顺德区兴发路 4 号 (528325)

Add: No.4, Beihe Industrial Park, Shunde, Foshan, Guangdong, China.

电话 /Tel: 0757-27382893

传真 /Fax: 0757-27782208

网址 /Web: www.zhongbaogd.com

广东中宝温控科技股份有限公司是一家专业生产 KSD301 系列突跳式温控器、KSD302 系列双极温控器、KSD306 系列大电流温控器、KST-205 系列可调式温控器企业。

本公司成立于 1990 年, 建有现代化生产厂房并引进日本和奥地利等国先进设备和技术, 公司有生产员工 400 多人, 管理及技术人员 50 多人。

Guangdong Zhongbao Thermostat Technology Co., Ltd. is a professional production of KSD301 Snap Action Bimetal Thermostat, KSD302 Bimetal Thermostat, KSD306 Bimetal Thermostat, KST-205 Bimetal enterprises.

The company was founded in 1990, has a modern production plant and the introduction of Japan and Austria and other foreign advanced equipment and technology, the company has more than 400 production staff, management and technical staff of more than 50 people. Since the establishment of the factory, the company has adhered to the "quality win, quality service" business policy, and strict use of international operating standards, to ensure that each product is tested by the computer system qualified, the annual output of more than 60 million.

#### 主要展品 /Products

KSD301 系列突跳式温控器、KSD302 系列双极温控器、KSD306 系列大电流温控器、KST-205 系列可调式温控器

KSD301 Snap Action Bimetal Thermostat, KSD302 Bimetal Thermostat, KSD306 Bimetal Thermostat, KST-205 Bimetal.

W2-2A43



### 广东中健医疗器械有限公司

W3-3H90

地址: 江门市新会区三江镇三江大道 63 号银洲湾科创产业园 3 座  
电话 /Tel: 18800175044

广东中健医疗器械有限公司致力于医疗器械、消毒器械、氢分子健康设备、食材净化设备、卫生用品、医用高分子材料等高科技产品的研发与生产。基地坐落于粤港澳大湾区的江门市新会区银洲湾科技产业园，拥有钣金加工，模具加工，注塑加工等配套基础加工产业。所有产品均已获得多项行业权威机构检测报告、CE 认证等；公司主要以 OEM、ODM 贴牌代工生产为主，自主开模，自主生产，拥有雄厚的基础配套产业。

#### 主要展品 /Products

氢氧产品系列: 氢氧混合机系列; 纯氢机系列; 纳米氢水机系列; 纳米氢泡浴机; 氢淋浴机; 氢足浴机; 纳米氢食材净化机等;  
消毒器械产品系列: 手部消毒机、空间空气消毒机、消毒液生成器、等离子紫外线空气消毒机等消毒器械产品;



### 广东众能物联科技有限公司

W4-4B36

地址: 广东省中山市坦洲镇潭隆北路 168 号众能科技园  
电话 /Tel: 0760-86630003  
网址 /Web: <http://www.znaiot.com/>

广东众能物联科技有限公司是一家专注于物联网智能连接领域的创新型国家高新技术企业。致力于物联网 IoT 模组以及应用的相关软硬件的研发、生产制造以及销售。

众能物联一直致力于向客户提供 RFID\NFC 射频标签 \ 模组、通信模组、雷达模组、蓝牙模组、语音模组、Wi-Fi 模组等物联网应用模组，并提供 AIoT 应用方案、云平台生态连接以及为全球 AIoT 解决方案公司提供 ODM&OEM 服务。

#### 主要展品 /Products

RFID\NFC 射频标签 \ 模组、通信模组、雷达模组、蓝牙模组、语音模组、Wi-Fi 模组等物联网应用模组，并提供 AIoT 应用方案、云平台生态连接以及为全球 AIoT 解决方案公司提供 ODM&OEM 服务。



### 广东钻厨电器有限公司

N3-3B08

#### GUANGDONG SHINECHEF ELECTRIC APPLIANCE CO.,LTD

地址: 佛山市顺德区均安镇百安南路 180 号之一 (528329)  
Add: NO.180,BAIAN SOUTH ROAD,JUNAN TOWN,SHUNDE DISTRICT,FOSHAN CITY  
电话 /Tel: 86-075729363326  
传真 /Fax: 86-075729363339

钻厨家用电器是属于一个大集团工厂，成立于 2014 年，主要从事多功能厨师机，分离式厨师机，调酒器，食物处理器等。所有的产品都有通过 CE, CB, UL, ETL, Rohs, LVD, EMC, EMF, REACH, LFGB and FDA 测试标准以及有相应的认证，同时公司已取得 BSCI, ISO 等管理认证。产品主要出口国为欧洲，美洲，亚洲，中东等全球。

#### 主要展品 /Products

揉面机，空气烤箱，食物处理器



### 广云物联 GranwinIoT

#### 广云物联网科技(广州)有限公司

W3-3B35 3B36

#### Granwin IoT Technology (Guangzhou) Co., Ltd

地址: 广州市黄埔区神舟路润慧科技园 C 栋 801  
Add: 801, Building C, Runhui Science Park, Shenzhou Road, Huangpu District, Guangzhou City  
电话 /Tel: 400-833-2500  
网址 /Web: <https://www.granwin.com>

广云物联是一家专业物联网解决方案提供商，聚焦于消费与产业物联网软硬件服务。为全球企业客户提供物联网生态接入、物联网云平台搭建、物联网 APP 开发、物联网模组硬件供应、物联网垂直行业方案等一站式服务。

Guangyun IoT is a professional IoT solution provider focusing on consumer and industrial IoT software and hardware services. Provide global enterprise customers with one-stop services such as IoT ecological access, IoT cloud platform construction, IoT APP development, IoT module hardware supply, and IoT vertical industry solutions.

#### 主要展品 /Products

米家服务: 广云物联与小米生态合作，提供智能家居解决方案和产品，为用户提供更加便捷的智能生活体验

一站式私域物联网平台: 广云物联提供私有云、边缘计算、数据分析等一系列，帮助企业快速建立自己的物联网平台，实现数字化转型

智能跳绳解决方案: 广云物联的智能跳绳解决方案是一款创新的健身产品，结合智能硬件和移动应用程序。它可以追踪用户的跳绳次数、时间、热量消耗和其他健身数据，同时提供个性化的健身计划和挑战模式

- Mi Home Service: Guangyun IoT cooperates with Xiaomi's ecosystem to provide smart home solutions and products, providing users with a more convenient smart life experience.

- One-stop Private Domain IoT Platform: Guangyun IoT provides a series of IoT services such as private cloud, edge computing, and data analysis to help enterprises quickly establish their own IoT platform and achieve digital transformation.

- Smart Jump Rope Solution: Guangyun IoT's Smart Jump Rope Solution is an innovative fitness product that combines smart hardware and mobile applications. It can track users' jump counts, time, calorie consumption, and other fitness data, while providing personalized fitness plans and challenge modes.

## SAFTTY®

广州安的电子有限公司

Saftty Electronic Technology Co., Limited

W2-2A44

地址: 广州市番禺区番禺大道北 555 号天安发展大厦 613 (511450)

Add: 613, Tian'an Hi-Tech Development Plaza, No.555 Panyu North Avenue, Panyu,

Guangzhou, 511493 China

电话 /Tel: 020-34826856

网址 /Web: www.saftty.cn

广州安的电子有限公司成立于 2008 年, 同年在扬州投资设立制造工厂, 2011 年在番禺新造设立新工厂, 2013 年公司在扬州建立生产二厂。

安的电子是中国国家自动控制标准技术委员会委员企业, 拥有十多项国家专利。

安的主要研发生产销售各类热保护器, 温控开关, 产品广泛应用于医疗器械、电机、水泵、风机、散热风扇、电源、电焊机、电池组、变压器、镇流器、照明设备, 家用电器电加热产品的过流过热保护领域。

Saftty specializes in R&D and manufacturing all kinds of micro thermal protectors, which are widely used in battery packs, electric motors, water pumps, fans, transformers, coils, windings, portable power tools, electric heating appliances and home appliances for overheat and over-current protection. The brand "SAFTTY" (short for safety technology) means: providing safe products to customers; providing a secure working environment to staff; and providing steady investment return to shareholders.

### 主要展品 /Products

温控开关、热保护器、温度开关、温湿度传感器

Thermal Protectors, Sensors

## 奥松电子

ASAIR

广州奥松电子股份有限公司

Guangzhou Aosong Electronic Co., Ltd.

W3-3A36 3A37

地址: 广州市黄埔区云骏路 17 号 (510530)

Add: No. 17, Yunjun Road, Huangpu District, 510530 Guangzhou, China

电话 /Tel: 020-82018320

传真 /Fax: 020-89852796

网址 /Web: www.aosong.com

奥松电子是应用 MEMS 半导体工艺技术生产传感器特色芯片的国家级专精特新“小巨人”企业, 也是 MEMS 领域集研发、设计、制造、封装测试、终端应用为一体的智能传感器全产业链企业, 拥有先进的 MEMS 特色芯片生产线, 已研发制造出温湿度、流量、压力、气体、光学、磁、红外、真空、水蒸气、颗粒物、粒子探测器等众多传感器产品, 为国内发展家电、医疗、汽车、工业等新一代信息技术领域提供硬件技术支撑, 实现国产替代进口。

Guangzhou Aosong Electronic Co., Ltd. is a national-level specialized "Small Giant" enterprise that applies MEMS semiconductor technology to produce sensor chips. It is also a smart sensor industry chain enterprise that integrates research, development, design, manufacturing, packaging, testing and final application in the MEMS field. It has advanced MEMS chip production line, and has developed and manufactured sensors to measure temperature and

humidity, flow, pressure, gas, optics, magnetism, infrared, vacuum, water vapor, particulate matter, particle detectors... and many other sensor products. Aosong also provides hardware and technical support for the domestic development of new generation of information technology fields, such as home appliances, medical care, automobile, industry, and realize the substitution of foreign products.

### 主要展品 /Products

公司主营产品有温湿度传感器、流量传感器、压力传感器、气体传感器、光学传感器、磁传感器、红外传感器、真空传感器、水蒸气传感器、颗粒物传感器、粒子探测器等。

Main products in Aosong include temperature and humidity sensor, flow sensor, pressure sensor, gas sensor, optical sensor, magnetic sensor, infrared sensor, vacuum sensor, water vapor sensor, particle sensor, particle detector, etc.

## PARKOO 百奥®

广州东奥电气有限公司

Guangzhou Dongao electrical Co., Ltd.

W2-2E61

地址: 广州市荔湾区浣花路 109 号首层 (510145)

Add: Guangzhou Dongao electrical Co., Ltd.

电话 /Tel: 020-81008988

传真 /Fax: 020-81008990

网址 /Web: https://www.parkoo.cn

广州东奥电气有限公司成立于 2006 年, 注册商标“PARKOO 百奥”百奥始终专注于环境温度湿度领域, 以创新技术和优质产品驱动企业发展, 赢得客户信赖。致力于成为全球领先的室内环境改善产品和解决方案供应商。公司主营移动空调、家用除湿机、工业除湿机、工业空调、热泵烘干机等产品。建有佛山、珠海两大制造基地, 生产车间面积超 100000 m<sup>2</sup>, 拥有 6 条家用产品、4 条工业产品全自动生产线, 年产能超过 150 万台。

Guangzhou Dong'ao Electric Co., Ltd. was founded in 2006 with the registered trademark "PARKOO". PARKOO has always focused on the field of environmental temperature and humidity, driven the development of enterprises with innovative technology and high-quality products, and won the trust of customers. We are committed to becoming the world's leading supplier of indoor environment improvement products and solutions. The company mainly sells mobile air conditioners, household dehumidifiers, industrial dehumidifiers, industrial air conditioners, heat pump dryers and other products. There are two major manufacturing bases in Foshan and Zhuhai, with a production workshop area of more than 100000 m<sup>2</sup>, 6 household products and 4 automatic production lines for industrial products, and an annual production capacity of more than 1.5 million units.

### 主要展品 /Products

公司主营移动空调、家用除湿机、工业除湿机、工业空调、热泵烘干机等产品。

he company mainly sells mobile air conditioners, household dehumidifiers, industrial dehumidifiers, industrial air conditioners, heat pump dryers and other products.



## HOKO 海科

广州海科电子科技有限公司

Guangzhou Haiketechnology Co., Ltd

W1-1A51 1A52

地址: 广州市南沙区东涌镇朗晴路1号(厂房九)406室

电话 /Tel: 34781536

网址 /Web: www.gzhaike.com

广州海科电子科技有限公司成立于2005年,是一家以滤网过滤技术为核心,以空气净化器,净水器等绿色小家电产品为主营业务,以自主品牌和OEM,ODM为经营模式的家电企业。公司旗下拥有空气净化器,净水器等小家电产品总装的综合生产能力。海科始终坚持“持续为目标客户创造价值”的经营理念,坚持用科技创新打造自己的核心竞争力,引领国内空气净化器行业的技术发展,在健康家电领域具有重要地位和影响力。

### 主要展品 /Products

空气净化器、厨下净水器、免安装台式饮水机、果蔬消毒机、洗碗机



广州亨龙智能装备股份有限公司

Heron Intelligent Equipment Co., Ltd

W2-2A01 2A02

地址: 广州市从化区太平镇新一路63号(510990)

Add: 63 Xinyi Road, Taiping Town, Conghua District, Guangzhou

电话 /Tel: 020-87813325

传真 /Fax: 020-87813346

网址 /Web: www.heronwelder.com

亨龙1991年创始于广州,拥有员工300余人,研发制造基地建筑面积54,000m<sup>2</sup>。

专注于金属连接工艺,拥有中频逆变直流、中压电容储能电阻焊核心技术,以及先进的铆接技术。服务于汽车车身制造、汽车零部件制造、低压电气制造、压缩机制造、家电制造、五金制造、电机制造等行业。亨龙追求卓越,持续为制造业提供高端节能环保的金属连接装备,客户遍及欧美等十多个国家和地区。

HERON was founded in 1991 in Guangzhou, with over 300 employees and running more than 54,000 square meter manufacture factory.

Focus on Metal Connection Technology: Heron has the core technology of MFDC, medium voltage capacitor discharge resistance welding, and advanced clinching technology.

Main Application Industries: Automotive manufacturing, automobile parts manufacturing, low-voltage electrical manufacturing, compressor manufacturing, household appliances and hardware manufacturing, motor manufacturing and other industries.

Aiming at Excellence: Heron provides continuously leading-edge energy-saving and environment friendly metal connection equipment, whose customers spread over 10 countries and regions, including the world's top 500 and other enterprises located in Europe and North America.

### 主要展品 /Products

中压电容储能焊机、中频焊机、一体化手工焊钳、伺服机器人焊钳、铆接机、控制器、自动化生产线

Main Application Industries: Automotive manufacturing, automobile parts manufacturing, low-voltage electrical manufacturing, compressor manufacturing, household appliances and hardware manufacturing, motor manufacturing and other industries.



恒星传导

广州恒星传导科技股份有限公司

HANSTAR WIRE AND CABLE TECHNOLOGY CO., LTD

W2 2B46

地址: 广东省广州市荔湾区东沙街东沙工业区五菱路3号(510380)

Add: 3 Wuling Road, Dongsha Street, Gaungzhou, Guangdong, China

电话 /Tel: 02081493939

传真 /Fax: 02081493622

网址 /Web: www.hanstar-gz.com

广州恒星传导科技股份有限公司成立于1989年,具有国际上先进的耐高温电线制造设备及数字化加工工艺,通过了UL、VDE及IATF16949、ISO等系列国内外权威认证。拳头产品包括耐高温氟塑电线、硅胶电线、XL PVC/PE电线以线束定制产品服务,拥有完全自主知识产权。产品覆盖智能家电、照明、新能源光伏、汽车、储能、医疗设备等相关行业。我们以优良的产品和服务,为全球4000多家客户提供耐高温传导解决方案。

Hanstar is a temperature resistance cable solution supplier and manufacturer since 1989. Obtained ISO9001, ISO14001, IATF16949 quantity system certifications. Dedicated to product R&D, Hanstar now has UL, cUL, VDE certified products. Providing high standard FEP, PFA, ETFE, PE, XLPE, PVC, Silicon insulation wire & cable products and cable harness in smart appliances, lighting, new energy photovoltaic, automobile, energy storage, medical equipment and other industries. Over 30 years, our professional team have served over 4000 customers around the world.

### 主要展品 /Products

耐高温氟塑电线、低烟无卤电线、电子线、交联辐照电子线、家电线束、照明线束、新能源汽车线束  
Temperature Resistance Cable, Electrical Cable, Silicone Rubber Cable, LOSH Halogen Free Cable, Customized Wire & Cable Solution



广州机智云物联网科技有限公司

Guangzhou Gizwits IoT Technology Co., Ltd.

W4-4C86

地址: 广东省广州市天河区陶庄路5号空间8楼

Add: F8, No.5 Public Space, Taozhuang Road, Tianhe District, Guangzhou, China

电话 /Tel: 020-2919-7322

网址 /Web: www.gizwits.com

机智云是全球领先的AIoT开发及云服务平台,第三方物联网云平台代表企业,国家高新技术企业,广东省专精特新企业。机智云聚焦物联网、大数据、人工智能、区块链及5G等新一代信息技术,通过自主可控的AIoT开发及云平台、“软件+硬件+数据+算法”端到端一站式解决方案,为客户提供设备物联、数据采集分析、远程在线监测/诊断、智能运维、预测性维护、故障/工单处理、资产管理等服务,助力企业实现数字化、智能化转型。

### 主要展品 /Products

机智云一站式AIoT智能家电解决方案;机智云智能云模组;机智云智能DTU/云网关;机智云智能家居私有云部署解决方案。

## 金升阳 MORNSUN®

广州金升阳科技有限公司

MORNSUN Guangzhou Science & Technology Co., Ltd.

地址: 广东省广州市黄埔区科学城科学大道科汇发展中心科汇一街 5 号 (510663)

电话 /Tel: 020-38601850

传真 /Fax: 020-38601272

网址 /Web: <https://www.mornsun.cn/>

W4-4D81

金升阳, 国家高新技术企业, 已连续五年荣登广东省制造业 500 强榜且排名稳步提升, 是国内集研发、生产、销售于一体的服务全球的电源解决方案提供商, 也是拥有强大自主研发和知识产权优势的创新型企业。金升阳自主创立“MORNSUN”品牌, 商标已在全球 50 多个国家与地区注册。我们致力于在家电行业等领域提供一站式电源解决方案, 帮助客户提高生产效率和能源效率, 同时降低对环境的不良影响, 为客户提供“无忧电源”。

Mornsun, a national high-tech enterprise, has been ranked among the top 500 manufacturing companies in Guangdong Province for five consecutive years and its ranking has steadily improved. It is a domestic power supply solution provider integrating R&D, production and sales to serve the world. It is also a powerful independent R&D provider. and innovative enterprises with intellectual property advantages. Mornsun independently founded the "MORNSUN" brand, and the trademark has been registered in more than 50 countries and regions around the world. We are committed to providing one-stop power supply solutions for the home appliance industry and other fields, helping customers improve production efficiency and energy efficiency, while reducing the adverse impact on the environment, and providing customers with "worry-free power supply".

### 主要展品 /Products

1-15W AC/DC 电源模块 LS-R3 系列

15-1000W AC/DC 机壳开关电源 LM/LMF 系列

DC/DC 电源模块 R5 系列

R5 总线隔离收发芯片

1-550W AC/DC 电源模块

0.2-400W DC/DC 电源模块

1-15W AC/DC Power Module LS-R3 Series

15-1000W AC/DC case switching power supply LM/LMF series

DC/DC Power Module R5 Series

R5 bus isolated transceiver chip

1-550W AC/DC Power Module

0.2-400W DC/DC Power Module



广州鹏辉能源科技股份有限公司

Guangzhou Great Power Energy & Technology CO., LTD.

地址: 广州市番禺区沙湾镇市良路西村段 912 号

Add: 912 Shiliang Rd (Xicun Section), Shawan, Panyu, Guangzhou, China

电话 /Tel: 020-39196888

网址 /Web: <http://www.greatpower.net/>

W4-4H66

鹏辉能源 (深圳创业板, 股票代码 300438) 成立于 2001 年, 注册资本 4.2 亿元人民币, 是一家 20 余年来专注于锂电池生产制造与研发的高新技术企业, 现正全力聚焦储能领域, 以高标准严格要求做好产品, 致力于成就客户, 成为储能电池的首选品牌!

Great Power (Stock Code: 300438) was founded in 2001, and is a high-tech enterprise focusing on manufacturing, researching and developing lithium batteries with more than 20 years technology accumulations. Now Great Power is fully focusing on ESS, developing batteries with high standards and strict requirements, committed to creating values for customers and becoming the preferred brand of ESS batteries!

### 主要展品 /Products

储能电池、消费类电池、数码类电池、一次性电池、锂铁电池、锂锰电池、18650、21700



广州飒特红外股份有限公司

Guangzhou SAT Infrared Technology Co., Ltd.

地址: 广州市经济技术开发区东江大道 10 号 (510730)

Add: Guangzhou SAT Infrared Technology Co., Ltd.

电话 /Tel: 020-82218466

网址 /Web: <https://www.sat.com.cn/>

W3-3E91

飒特红外: All-in-One 红外应用全栈式服务平台, 为 B 端工业、C 端消费及安防、医疗等领域客户, 提供一站式红外应用产品与解决方案。创始于 1991 年, 飒特红外是国内第一家立项从事民用红外热成像产品研发的高新技术企业, 《工业检测型红外热像仪》国家标准制定单位; 自主掌握“红外图像算法、软硬件设计、平台研发、智能交互、AI 识别”等全链路核心技术。2022 年, 成立全资子公司盈孚睿泰, 推出多款消费品质热像仪。

SAT Infrared: All-in-One infrared application full-stack service platform, providing one-stop infrared application products and solutions for B-end industrial, C-end consumer and security, medical and other fields of customers. Founded in 1991, SAT Infrared is the first high-tech enterprise in China engaged in the research and development of civil infrared thermal imaging products, and is also the developer of "Industrial Inspecting Thermal Imagers"; It has mastered the "infrared image algorithm, hardware and software design, platform development, intelligent interaction" and other full-link core technologies. In 2022, Guangzhou Infrared Technology CO.,LTD, a wholly-owned subsidiary, was established to launch a variety of consumer thermal imaging cameras.

**主要展品 / Products**

卓越 S1 手机热像仪、MiniR256 智能双摄热像仪、NV628 车载夜视辅助系统、UPC 非制冷长波红外热成像机芯、T2SL 二类超晶格机芯、CK360-M 医用型红外热像仪、单筒红外夜视仪 L608、医疗测温仪 FTA-300

Excellent smart thermal camera S1, Intelligent dual-vision thermal imaging camera MiniR256, Vehicle night vision assist system NV628, Uncooled long-wave thermal imaging core UPC, Type II superlattice core T2SL, Medical thermal imaging camera CK360-M, Monocular infrared night vision camera L608, Medical thermometer FTA-300

**胜维®****广州胜维电器制造有限公司****N3-3D96****Guangzhou Shengwei Electric Manufacturing Company Limited**

地址: 广州市花都区花东镇金田工业园 (510030)

Add: Jintian Industrial Park, Huadong Town, Huadu District, Guangzhou

电话 /Tel: 020-83649971

传真 /Fax: 020-83649762

网址 /Web: www.sunwayind.com

广州胜维电器制造有限公司始建于 2004 年, 系国内知名的中高端厨房小家电制造商。我司生产基地坐落于广州花都, 通过 ISO9001 认证。公司拥有优秀的自主设计、研发团队, 产品以中高端智能小家电为主, 主要产品有多功能料理机、智能高压锅、智能电饭煲、搅面机、高速破壁机、咖啡机和切片机等。我司产品通过多个国内外质量认证如 3C CB GS CE RED SAA ETL ECBC 等 及多项化学测试认证。

Guangzhou Shengwei Electric Manufacturing Company Limited gets our start in 2004 and has become a well-known manufacturer for the mid-range to high end smart kitchen household appliance.

Our manufacturing sites located in Guangzhou, Guangdong, China. Shengwei is with ISO9001 certification. We have excellent independent product design and R&D team. The majority of our products are the mid-range to high end smart kitchen household appliance. Our product lines include kitchen machine, intelligent pressure cooker, intelligent rice cooker, Stand mixer, High-speed blender, coffee machine and slicer, etc.

All our products have passed many domestic and overseas quality certification, such as 3C, CB, GS, CE, RED, SAA, ETL, ECBC and series chemical test approval.

With good quality control process and strong production capacity, we manufacture OEM/ODM products for lots of famous brands and we established a strong cooperation with lots of large supermarket chains in Europe, America, etc.

**主要展品 / Products**

多功能料理机、智能高压锅、智能电饭煲、搅面机、微蒸烤一体机

Intelligent pressure cooker, Intelligent rice cooker, Stand mixer, Steam microwave oven

**RED SUN****广州市红日燃具有限公司****N1-1C81**

地址: 广州市白云区神山大道东 650 号

电话 /Tel: 020-86404225

网址 /Web: http://www.redsun.com

红日厨卫成立于 1981 年, 是自主创新型国家高新技术企业, 自主研发核心技术“高红外发射率多孔陶瓷节能燃烧器技术”入选《国家十二五计划重点节能技术推广目录》、《战略性新兴产业重点产品和服务指导目录》, 该技术被评定“中国双十佳最佳节能技术”、《国家重点节能技术推广目录》。红日推动并参与了国家标准《家用燃气灶具能效限定值及能效等级》的起草与实施, 引领灶具行业的产业升级换代。

**主要展品 / Products**

烟机 7908S、灶具 S75P、集成灶系列及各种特殊陶瓷燃气具技术产品

**SELON 聚赛龙****广州市聚赛龙工程塑料股份有限公司****W2-2A36****SUPER-DRAGON ENGINEERING PLASTICS CO., LTD**

地址: 广州市从化区鳌头镇龙潭聚宝工业区 (510945)

电话 /Tel: 13808816256

传真 /Fax: 020-87886446

网址 /Web: www.gzselon.com

广州市聚赛龙工程塑料股份有限公司成立于 1998 年, 是专业从事改性高分子材料和工程塑料的研发、生产和销售的高新技术企业。总部位于广州从化, 在华东、华南建有两大生产基地。公司拥有通用改性塑料、改性工程塑料、功能高分子材料等产品系列。核心产品通过了美国 UL 认证、CQC 认证。产品覆盖汽车、家电、电子电气、卫浴、5G 通讯、医疗等领域。

**主要展品 / Products**

PP、ABS、PC、PC/ABS、PBT、PET、HIPS、PPO、PPS 等。

**广州市狮霸电器制造有限公司****W5-5A21****Guangzhou siber Electric Mfg. Ltd**

地址: 广州市番禺区石基镇海涌路 121 号 (510000)

Add: Floor 3, No. 121 Haiyong Road, Shijie Town, Panyu District, Guangzhou City,

Guangdong Province

电话 /Tel: 020-85690459

传真 /Fax: 020-85677370

网址 /Web: http://www.siber.com.cn

施霸 (中国) 电器制品有限公司始创于 1999 年, 旗下有工厂: 佛山市施霸电器制品有限公司, 广州市施霸电器有限公司, 广州市狮霸电器制造有限公司。是国内一家专注于机电开关、家电开关、灯座、等电器配件研发制造的著名厂家, 产品出口到全球各地, 产品广泛应用于电子电器, 机电设备, 家用电器

器照明, 医疗器械, 自动化控制等各个领域。产品外形美观, 内部质量优秀, 质量稳定可靠, 售后服务完善, 以此赢得国内外众多用户的信赖。

Shiba (China) Electrical Products Co., Ltd. was founded in 1999, with the following factories: Foshan Shiba Electrical Products Co., LTD., Guangzhou Shiba Electrical Appliances Co., LTD., Guangzhou Shiba Electrical Appliances Manufacturing Co., LTD. Is a domestic focus on mechanical and electrical switch, electrical switch, lamp holder, and other electrical parts R & D manufacturers, products exported to the world, the products are widely used in electronic appliances, electrical and electrical equipment, household electrical lighting, medical instruments, automation control and other fields. Products beautiful appearance, excellent internal quality, stable and reliable quality, perfect after-sales service, in order to win the trust of many users at home and abroad

#### 主要展品 /Products

产品种类有电吹风开关, 滑动开关, 防水开关, 船形开关, 微动开关, 按钮开关, 旋转开关, 中途开关, 钮子开关, 过流保护开关, 保险丝座, 灯座, 插座, 指示灯等。产品广泛应用与电子电器, 仪器仪表, 机电设备, 广播通信, 家用电器, 家居和商业照明, 医疗器械, 汽车, 自动化控制等各个领域

The products include hair dryer switch, sliding switch, waterproof switch, boat switch, micro switch, button switch, rotary switch, halfway switch, toggle switch, overcurrent protection switch, fuse holder, lamp holder, socket, indicator light, etc. Products are widely used in electronic appliances, instrumentation, mechanical and electrical equipment, broadcast communication, household appliances, home and commercial lighting, medical instruments, automotive, automation control and other fields.



#### 广州市台博自动化设备有限公司 Guangzhou TaiBo Automatic Equipment Co.,Ltd

W1-1A25 1A26

地址: 广东省广州市番禺区石基镇小龙村后岗工业区 9 号

Add: Panyu District, Guangzhou, Guangdong, China No. 9 Hougang Industrial Zone, Xiaolong Village, Shiji Town

电话 /Tel: 020-85820705

网址 /Web: www.gztaibo.com

广州市台博自动化设备有限公司是一家从事开发、设计、制造、销售滚刷成套设备, 胶针拉伸设备等各种自动化生产设备的现代高科技企业。凭着多年自动化设计开发经验及雄厚的技术力量和可靠的产品质量, 以科技为龙头, 结合运用国内外技术, 成功为制刷、五金电镀、装修材料等行业中外知名厂家提供了一系列与世界水平同步的自动化设备及相关精密机械配件。尤其在运用自动控制技术方面非常成熟, 充分得到国内外同行的一致认可。

Guangzhou TaiBo Automatic Equipment Co.,Ltd--Leading and Professional Manufacturer of Paint Roller Machines.

As a well-recognized leading manufacturer which has been specialized in paint roller machines for more than 20 years in China, TAIBO has been exported machines to different countries all over the world, such as America, Canada, Germany, Italy, Greece, Poland, Hungary, Netherlands, Bulgaria, Portugal, Spain, Macedonia, Russia, Ukraine, Turkey, Brazil, Argentina, Chile, Colombia, Mexico, Australia, New Zealand, Japan, India, Nepal, Indonesia, Algeria, Vietnam, Myanmar, Sri

Lanka, Iraq, Uzbekistan, Malaysia, Singapore, Egypt, Philippines, Bangladesh, etc., and achieved great reputation both from domestic and overseas customers based on advanced technologies, superior quality, competitive price and professional after sales service.

#### 主要展品 /Products

洗地机 PUR 胶滚刷缠绕机; 全自动热熔胶缠绕机 (机械手); 全自动火烧缠绕机; 全自动大毛套切管、倒角、梳毛、剪毛生产线;

全自动小毛套切管熔尾机; 全自动小毛套压盖机; 全自动支架校直 / 打点 / 打扁 / 切断 / 折弯成型机

Fully-Automatic Washing and Scrubber Roller PURGlue Winding Machine;

Fully-automatic Paint Roller Hot Glue Winding Machine(Mechanical Arm);

Fully-automatic Paint Roller Hot Glue & Fire Thermobonding Machine;

Fully-automatic Big Roller Finishing Machine; Fully-automatic Big Roller Finishing Production Line ;

Automatic Mini Roller Caps Inserting Machine;

## TAIHENG®

广州市泰亨电子电器有限公司

W1-1B54

GUANGZHOU TAIHENG ELECTRIC APPLIANCE CO., LTD

地址: 广州市南沙区东涌镇市南公路东涌段 14 号

电话 /Tel: 13922301536

始建于 1993 年, 占地面积达到 10000 多平方米。是一家集生产, 加工和销售器具类开关为一体的专业化厂家泰亨产品涉及翘板开关, 按钮开关, 旋转开关和微动开关等十大大系列, 将近有 150 多种细分规格开关, 广泛运用于小型家用电器, 电信设备, 检测工具和医疗器械等等领域。

#### 主要展品 /Products

开关, 插座, 电源线



## CGMT

广州市微生物研究所集团股份有限公司

W5-5B25

Guangzhou Institute of Microbiology Group Co., Ltd.

地址: 广州市黄埔区科学城尖塔山路 1 号 (510663)

电话 /Tel: 020-61302680

传真 /Fax: 020-61302672

网址 /Web: www.ggtest.com.cn

广州市微生物研究所有限公司 (国家空气净化产品质量监督检验中心) 具有 CMA 和 CNAS 资质, 是国家权威的家电产品检测机构。我司参与了多项国家、行业和地方标准的修订 (GB/T18801-2015、ISO17094 (E) 等), 是国内领先的净化产品检测评价技术平台, 拥有国内数量最多、规格最齐全的净化器检测试验舱, 且仪器设备配置齐全。我司被授权为广东省室内环境行业协会的指定检测机构, 并得到国内外同行的高度认可。

Guangzhou Institute of Microbiology Co., Ltd. (National Air Purification Product Quality Supervision and Inspection Center) was founded in 1972. It is the national authoritative domestic appliances testing institution with qualifications of CMA and CNAS. Our company has



participated in the revision of a number of national, industrial and local standards (GB / T18801-2022, ISO17094 (E) and so on).

Our company's testing business scope covers: air purifiers, water purifiers, household appliances, disinfection products, public environment, clean engineering and so on. We are a leading technology platform for purification products detection and evaluation in China, which has the largest number and most complete specifications of purifier test chambers with complete equipment configuration.

#### 主要展品 /Products

空气净化器、空气消毒机  
Air Purifier, Air sterilizer

#### 广州市远威实业有限公司

#### 广州市远威实业有限公司 Triumph Electronics Co., Ltd

W4-4B53

地址: 广州·增城·增江·东区科技园·纬五路6号(511300)

Add: NO.6 Weiwu Road, Zengjiang Town, Zengcheng District, Guangzhou

电话 /Tel: 13925260730

传真 /Fax: 020-82725670

网址 /Web: www.34565.com

广州市远威实业有限公司成立于2004年,位于广州市增城区增江科技园,专注于铜铝钢数控车削件、PogoPin连接器、工业连接器,塑胶外壳开模注塑喷涂。公司拥有数控车床200多台,注塑机50多台,高端模房设备一批,车削各类五金接插件、异型件及制造各类便携产品塑胶外壳模具。产品用于电子产品、连接线、灯饰电器、医美器械、电机电控、安防锁具、军工航天、汽摩船舰等产品的电流信号连接或紧固组合。

Triumph Electronics Co., Ltd. founded in 2004, is located in East-Technology Park, Zengjiang Town, Zengcheng District, Guangzhou City, focusing on Copper, Aluminum, Steel CNC turning parts, PogoPin connectors, industrial connectors, plastic shells molding, injection, spraying. The company has more than 200 sets of CNC lathes and 50 sets of injection machines, a batch of high-end mold equipment, turning and manufacturing all kinds of hardware connectors, special -shaped parts, portable products plastic shell mold. Products with electronics, connectors, lines, lighting, appliances, medical equipment, motor, security, locks, military, aerospace, auto and motorcycles, ships and other products of the current signal connection or fastening combination.

#### 主要展品 /Products

- 1.pogopin 顶针
2. pogopin 连接器
3. 五金车削件
4. 弹片连接器
4. 五金冲压

#### Wanbao 万宝

#### 广州万宝家电控股有限公司

W5-5C31

#### Guangzhou Wanbao Household Electric Appliances Holding Co., Ltd.

地址: 中国广州市海珠区江南大道中路111号5楼(510220)

Add: 5th floor, NO.111 Jiangnan Avenue, Haizhu District, Guangzhou

电话 /Tel: 8620-89010088

传真 /Fax: 8620-89092989

网址 /Web: http://www.giihg.com

广州工控集团是按照市委市政府战略部署,由原万宝集团、广钢集团、万力集团于2019年联合重组成立,并于2021年完成对原广智集团重组。其中广州万宝品牌创立于1978年,以制冷产品、家用电器研发、生产、安装及销售等为主业,拥有广州、梅州、民权、青岛等生产基地,建有国家级企业技术中心、CNAS国家认可实验室和省工程技术研究开发中心,设立了博士后科研工作站,至重组前广州万宝连续18年位列中国企业500强。

Guangzhou Industrial Investment Holdings Group(“GIIHG”) was reorganized and established in 2019 by the former Wanbao Group, Guangzhou Iron & Steel Group and Wanli Group in accordance with the strategic deployment of the municipal party committee and the municipal government of Guangzhou, and completed the restructuring of the former GIE Group in 2021. Among them, Guangzhou Wanbao brand was founded in 1978, with the R&D production, installation and sales of Refrigeration products and household appliances as the main business, owns the production bases located in Guangzhou, Meizhou, Minquan and Qingdao, and has established a national enterprise technology center, a CNAS national accreditation laboratory and a provincial engineering & technology R&D center, has set up Post-Doctoral Scientific Research Workstation. Before the reorganization, GZ WANBAO ranked among the top 500 Chinese enterprises for 18 consecutive years.

#### 主要展品 /Products

冰箱、冷柜、空调(家用、商用、中央)、太阳能及热泵热水器(家用、商用)、家庭用小电器,制冷压缩机及配套产品

Mainly produce refrigerators, freezers, air conditioners (household, commercial and central), solar and heat pump water heater (household and commercial), small household appliances, refrigeration compressors and auxiliary products etc.

#### 银冠 V-CROWN

#### 广州银冠温控器有限公司

W1-1A44

地址: 广州市南沙区东涌镇鱼窝头大道同兴路一横16号

电话 /Tel: 18027131433

传真 /Fax: 020-34900303

亚洲最大温控器生产制造厂家之一

#### 主要展品 /Products

专业制造商用餐饮设备的温控器、温度表、限温器等。



### 广州优端环保科技有限公司

E2-2B24 2B25

#### Guangzhou Youduan Environmental Protection Technology Co., Ltd.

地址: 广州市白云区太和镇罗洞街 2 号 (1109662559)

Add: No. 2, Luodong Street, Taihe Town, Baiyun District, Guangzhou

电话 /Tel: 18206665938

网址 /Web: <http://www.gzyouduan.com/>

广州优端环保科技有限公司是一家自主研发、自主生产、独自模具、销售与一体的生产厂家;  
主营产品: 果蔬净化清洗机、洗碗机、空气净化机、除味净化器、超声波清洗机、净水器等;  
企业定位: 为渠道客户提供最专业的 OEM 贴牌、ODM 代工平台。

Guangzhou Youduan Environmental Protection Technology Co., Ltd. is a manufacturer integrating independent research and development, independent production, independent mold, sales and integration;

Main products: fruit and vegetable cleaning machines, dishwashers, air purifiers, deodorant purifiers, ultrasonic cleaners, water purifiers, etc.

Enterprise positioning: Provide channel customers with the most professional OEM and ODM platforms

#### 主要展品 /Products

主营产品: 果蔬净化清洗机、洗碗机、空气净化机、除味净化器、超声波清洗机、净水器等

Main products: fruit and vegetable cleaning machines, dishwashers, air purifiers, deodorant purifiers, ultrasonic cleaners, water purifiers, etc.



KUO TONG ELECTRICAL

### 国统电器科技(惠州)有限公司

E2-2C86

#### Kuo Tong Electrical Technology (Huizhou) Co., Ltd

地址: 广东省惠州市惠阳区良井镇秀峰村永平公路 442 号 (516265)

Add: No.442 Yongping Road, Xiufeng Village, Liangjing Town, Huiyang District, Huizhou City,

Guangdong Province

电话 /Tel: 0752-3911990

传真 /Fax: 86-0752-3911991

网址 /Web: <https://www.kuojun.com/>

国统电器科技(惠州)有限公司成立于 1970 年台湾。该公司在 1991 年扩大到深圳建厂然后在 2011 年搬厂至惠州。惠州工厂拥有 120000 m<sup>2</sup> 面积, 12 条现代生产线, 71 台注塑机器。产品主要出口到北美、欧洲、日本、澳大利亚、巴西、台湾等国家和地区。总产量超过 300 万台, 我们也生产药物吸入器、精油机、喷水扇、空气循环扇、搅拌机烤盘、和其他家庭厨房用具。

Guotong Electric Technology (Huizhou) Co., Ltd. was established in Taiwan in 1970. The company expanded to Shenzhen in 1991 and then moved to Huizhou in 2011. Huizhou factory has an area of 120000 square meters, 12 modern production lines and 71 injection molding machines. The products are mainly exported to North America, Europe, Japan, Australia, Brazil, Taiwan and other countries and regions. With a total output of more than 3 million units, including more than

2 million humidifiers and air purifiers, we also produce drug inhalers, noodle machines, essential oil machines, water spray fans, air circulation fans, agitators, baking pans, and other household kitchen appliances. We look forward to long-term cooperation and development with customers and jointly develop and research new products. We are honored to cooperate with some customers: hot, Kaz, Vicks, Honeywell, Hamilton Beach, iris OHYAMA (Japan), de 'Longhi and Chicco / artsanas, etc.

#### 主要展品 /Products

加湿器、三明治机、果汁机、循环扇、电风扇、铁板烧

Humidifier, sandwich machine, juicer, circulating fan, electric fan, teppanyaki.



### 海尔智家股份有限公司

#### Haier Smart Home Co., Ltd.

N5

地址: 青岛市崂山区海尔工业园内 (26600)

Add: Haier Information Industrial Park, Laoshan District, Qingdao City, Shandong Province

电话 /Tel: 0532-88931670

传真 /Fax: 0532-88931670

网址 /Web: [www.haier.com](http://www.haier.com)

海尔集团创立于 1984 年, 连续 3 年作为全球唯一生态品牌蝉联 BrandZ 最具价值全球品牌榜, 连续 13 年稳居欧睿国际世界第一家家电品牌。旗下子公司海尔智家位列《财富》世界 500 强, 拥有 Haier、Casarte、Leader、GE Appliances、Fisher & Paykel、AQUA、Candy 等高端品牌和全球首个场景品牌“三翼鸟”, 深入全球 160 个国家和地区, 服务全球 10 亿 + 用户家庭。

Established in 1984, Haier Group is the world's only ecosystem brand that has been included on the list of BrandZ Most Valuable Global Brands for three years straight and has topped Global Major Appliances Brand Rankings by Euromonitor International for 13 consecutive years. Its subsidiary Haier Smart Home is among the list of Fortune Global 500. The Group has seven upscale brands such as Haier, Casarte, Leader, GE Appliances, Fisher & Paykel, AQUA and Candy, and the world's first scenario brand THREE WINGED BIRD, which reaching 160 countries and regions and serving 1 billion + user families around the world.

#### 主要展品 /Products

冰箱、洗衣机、空调、电视、热水器、净水器、洗碗机、冷柜、生活家电等

Refrigerator, washing machine, air conditioner, TV, water heater, water purifier, dishwasher, freezer, household appliances, etc.



### 海南瑞德利晨先进科技发展有限公司

N4-4B36

#### Hainan Ruidelichen Advanced Technology Company Limited

地址: 海南省三亚市崖州区崖州湾科技城海南瑞泽办公楼 3 楼 07 室 14 号 (572000)

Add: No.14, Room 07, Floor 3, Ruize building, Yazhou Bay, Yazhou district, Sanya City,

Hainan Province

电话 /Tel: 18910612557

传真 /Fax: 010-87160860

网址 /Web: <https://item.jd.com/100040997955.html>

德国 TROTEC 公司是欧洲领先的空气净化装备的制造商, 1985 年成立。2020 年 9 月推出第一款专门针对室内病毒 / 气溶胶净化的空气净化器 TAC V+; 2021 年 3 月推出家用型空气净化器 AGC1。海南瑞德利晨先进科技发展有限公司 2015 年成立, 是德国 TROTEC 公司中国独家代理。2021 年通过国家高新技术企业认定。

The German TROTEC company is a European manufacturer of advanced air purification equipment, established in 1985. It is one of the leaders in air purification filed in Europe. In September 2020, the first commercial air purifier TAC V+ specially designed for indoor virus/aerosol purification has been launched, and the household air purifier AGC1 (Airgoclean One) has been launched in March 2021. Both machines are equipped with HEPA H14 grade filters, with 99.995% filtration efficiency against virus/aerosol particles of 0.1-0.3 micron diameter. Hainan Ruide Lichen Advanced Technology Development Co., Ltd. was established in 2015 and is the exclusive agent of German TROTEC company in China. In 2021, it will be recognized as a national high-tech enterprise.

#### 主要展品 /Products

HEPA H14 级过滤器, 针对 0.1-0.3 微米直径的病毒 / 气溶胶微粒过滤效能 99.995%。

家用型空气净化器 AirgoClean One: 2021 年 3 月推出。适用面积 78 平方米。CADR (洁净空气量): 600 立方米 / 小时 (H14: 99.995%)

空气净化器 TAC V+: 2020 年 9 月推出。适用面积 200 平方米。CADR (洁净空气量): 1800 立方米 / 小时 (H14: 99.995%)

Household air purifier AirgoClean One: Applicable area is 78 square meters. CADR: 600 m<sup>3</sup>/H (H14: 99.995%)

Commercial air purifier TAC V+: The applicable area is 200 square meters. CADR (clean air volume): 1800 m<sup>3</sup>/H (H14: 99.995%)

## WatenJoy 水享

### 海宁市水享净水设备有限公司

N3-3F81

地址: 浙江省嘉兴市海宁市农发区启辉路 5 号 (314400)

电话 /Tel: 13867433200

传真 /Fax: 4006616818

网址 /Web: <http://www.watenjoy.cn/>

国家高新技术企业, 位于海宁市高新区, 为国内外前置过滤器研发、生产、制造龙头企业, 为海内外超 300 家知名企业提供专业的前置 OEM 和 ODM 服务; 公司一直以提高产品质量和增加产品的科技含

为使命、以给用户提供更完善的服务为己任, 可以更安全、放心的应用于各种水家电产品以及净水设备设施, 是民用和商用水质预处理的防护盾。

#### 主要展品 /Products

前置过滤器, 智能漏水保护器, 净饮机, 沐浴宝, 美妆冰箱, 中央前置过滤器



### 海速芯 (杭州) 科技有限公司

W1-1C76

#### Hitenx(Hangzhou)Technology Co.,Ltd

地址: 浙江省杭州市西湖区华星路 99 号创业大厦七楼 A701-A705(单号), A702-A706(双号)(214135)

Add: A701-A705, A702-A706, 7th floor, Chuangye building, No. 99, Huaxing Road, Xihu District,

Hangzhou, Zhejiang

电话 /Tel: 0571-89360656

传真 /Fax: 0571-89360656

网址 /Web: <http://www.hitenx.com.cn/>

海速芯成立于 2019 年, 拥有十速 (TENX) 知名品牌。公司以 MCU 为核心, 专注于数模混合信号芯片、模拟芯片的研发与销售。主要产品包括家电控制芯片、消费电子芯片、传感器信号处理芯片、超低功耗芯片及功率器件等, 广泛应用于家用电器、消费电子、电机、医疗健康、工业控制、安防等领域。公司拥有资深的管理和研发团队, 在无锡、上海、杭州、顺德、香港等地设有研发中心和分支机构, 拥有超过百项专利。

#### 主要展品 /Products

家电控制 MCU、消费电子 MCU、传感器信号处理芯片、超低功耗芯片及功率器件

## Hisense

### 海信集团控股股份有限公司

W5-5F01 5F11 5F31 5F51 5F71

#### Hisense

地址: 山东省青岛市市南区东海西路 17 号 (266071)

Add: No.17 Donghai Xi Road, Qingdao, China 266071

电话 /Tel: 4006111111

网址 /Web: <http://www.hisense.cn>

海信成立于 1969 年。拥有海信视像 (600060)、海信家电 (000921) 和三电控股 (6444) 三家在上海、深圳、香港、东京四地的上市公司, 旗下有海信 (Hisense)、东芝电视 (TOSHIBA)、gorenje、科龙 (KELON)、容声 (Ronshen)、ASKO 与 Vidda 等多个品牌。2021 年, 海信营收 1755 亿元, 同比增长 24%。海外收入 731 亿元, 同比增长 33%; 自主品牌占比超 80%。

Hisense was founded in 1969. At present, Hisense owns three listed companies—Hisense Visual Technology (600060), Hisense Home Appliances (000921) and SANDEN (6444) listed in Shanghai, Shenzhen, Hong Kong, and Tokyo. And it also owns many brands including Hisense, TOSHIBA, gorenje, KELON, Ronshen, ASKO and Vidda. In 2021, the operating revenue of Hisense group was CNY 175.5 billion, increased 24%. The overseas income reached CNY 73.1 billion, increased 33%; and private brands accounted for more than 80%.

**主要展品 /Products**

海信业务涵盖多媒体、家电、IT 智能信息系统和现代服务业等多个领域。以彩电为核心的 B2C 产业，海信始终处在全球行业前列；在智慧交通、精准医疗和光通信等新动能 B2B 产业，海信也占据了全国乃至全球领先地位。

The business covers areas including multimedia, home appliances, IT intelligent information and modern service industries. With the Smart TV as the core, Hisense B2C business has always been at the forefront of the global industry. Hisense is also the global leading brand in B2B industries including Intelligent Transportation, Intelligent Medical and Optical Modules.

**汉斯希尔****汉斯希尔贸易(上海)有限公司****SYR TRADING (SHANGHAI) CO., LTD**

地址: 上海市静安区永和路 118 弄 25 号 (200072)

Add: No 25, Lane 118 Yong He Road, Shanghai, China

电话 /Tel: 02163760637

传真 /Fax: 02136530087

网址 /Web: www.syr-china.de

SYR 品牌创立于 1939 年, 隶属于德国汉斯萨瑟莱斯两合公司, 是一家自主生产、研发高端水处理设备和控制阀的老牌德国家族企业。除德国以外, 在比利时、波兰、奥地利、俄罗斯、南非以及中国设立分支机构。SYR 品牌于 1998 年进入中国。经过 20 余年的深耕精作, 于 2019 年, 用多年累积的经验, 总结出带有自身品牌特质的“全屋用水 4.0 净护智享方案”, 倡导消费者提升“全屋净水, 不止饮水”的全新认知。

Reliable technology, top quality design and innovative communication possibilities: This is what characterizes the products of the SYR brand. Our water management and heating protection solutions are true masterpieces when it comes to functionality and safety in their respective fields of use because SYR creates convincing additional benefit by combining different valves and application possibilities. As a consequence, SYR valves are always compact and easy to service, starting with the fitting flange connection of our potable water filter all the way to the flexible cartridge system in our heating water conditioning unit.

You can find SYR products around the world. We coordinate the activities of our locations in China, Russia, South Africa, Poland and Belgium out of our Korschenbroich headquarters. No matter where you buy a SYR product, one thing is clear: our promise of quality applies all over the world!

**主要展品 /Products**

公司主营业务涉及水处理设备、安全阀、防污隔断、减压阀、暖通阀门等; 其中水处理设备包括前置过滤、末端净水、中央软水、中央净水、防漏保护和暖通水净化等品类。

The company's main business involves water treatment equipment, safety valves, backflow preventer, pressure reducing valves, water treatment for heating systems, heating valves etc; Water treatment equipment includes backwash filter, terminal water filter, central water softener, central water purification, leakage detection, etc.

**E1-1F01****汉王科技股份有限公司**

地址: 北京市海淀区中关村软件园汉王大厦

电话 /Tel: 010-82786500-4924

汉王科技股份有限公司成立于 1998 年, 作为国内人工智能产业的先行者, 汉王科技潜心深耕二十余载, 始终致力于多领域智能交互技术的研究与应用。在手写识别、光学字符识别 (OCR)、人脸识别、笔迹输入等领域拥有多项具有自主知识产权的核心技术, 其中手写汉字识别获得国家科技进步一等奖, OCR 识别获得国家科技进步二等奖。

**主要展品 /Products**

汉王手写电纸本系列产品, 汉王柯式音法血压计, 汉王掌静脉识别终端, 汉王智能图像识别枪, 汉王扫描王软件

**W3-3H41****汉洋(博罗)电子有限公司****Han Yang (Boluo) Electronics Ltd.**

地址: 广东省博罗县石湾镇江滨路 101 号内第二栋

电话 /Tel: 07526866236

汉洋(博罗)电子有限公司为独资企业, 成立以来一直专注于从事高科技、通讯、消费电子产品、手机周边附件产品、礼品的研发、生产、销售业务, 其主要产品为各类拉杆天线、橡胶天线、橡胶制品、五金制品、各类触控笔、电容笔、蓝牙自拍杆、RFID 卡片钱包、汽车手机座、单车手机座、背包扣、运动手臂带、空气净化灯、便携式车载杀菌消毒器、便携式消毒衣架、等等的产品。

Han Yang (Boluo) Electronics Ltd a wholly-owned enterprise, has been focusing on the R&D, production and sales of high-tech, communications, consumer electronics, mobile phone peripheral accessories, and gifts since its establishment. Its main products are all kinds of rod antennas, rubber antennas, rubber products, hardware products, all kinds of touch pens, capacitance pens, Bluetooth self-timer bars, RFID card box wallets, car phone seats, bicycle phone seats, backpack buckles Sports arm belt, air purification lamp, portable vehicle-mounted sterilizer, portable disinfection clothes rack, and other products.

**主要展品 /Products**

产品为各类拉杆天线、橡胶天线、橡胶制品、五金制品、各类触控笔、电容笔、蓝牙自拍杆、RFID 卡片钱包、汽车手机座、单车手机座、背包扣、运动手臂带、空气净化灯、便携式车载杀菌消毒器、便携式消毒衣架、等等的产品,

The products are all kinds of rod antennas, rubber antennas, rubber products, hardware products, all kinds of touch pens, capacitance pens, Bluetooth self-timer bars, RFID card box wallets, car mobile phone seats, bicycle mobile phone seats, backpack buckles, sports arm belts, air purification lamps, portable on-board disinfection disinfectors, portable disinfection hangers, and other products,

**W5-5A06**



**DE&E 德意****杭州德意智家股份有限公司**

地址: 浙江省杭州市萧山经济开发区桥南区块鸿兴路 98 号 (311231)

电话 /Tel: 0571-82834888

传真 /Fax: 0571-82835278

网址 /Web: www.chinadee.com

德意始创于 1992 年, 坚持“为了帮助人们实现更高品质、更加美好生活”的使命, 以原创设计和领先科技作为双核驱动, 全力将公司打造成为集厨卫电器、全屋定制、智能家居为一体的并拥有核心价值和竞争力的全球一流大家居企业。德意拥有行业最先进的“4.0 智慧工厂”, 成功打造全国 7000 余个销售终端, 并与国内多家百强房企达成工程战略合作, 产品畅销欧洲、澳洲、美洲等 50 多个国家, 成为全球家庭信赖的中国制造品牌!

**主要展品 /Products**

油烟机、大火力燃气灶、集成灶、嵌入式消毒柜、嵌入式蒸烤一体机、嵌入式蒸箱、嵌入式烤箱、嵌入式洗碗机、集成水槽、热水器、净水器

**N1-1C41****杭州凡诺电子有限公司****Fannal Electronics Co.,Ltd.**

地址: 杭州市余杭区星桥经济开发区博旺街 77 号 6 楼 (311100)

Add: 6F, No.77 Bowang Street, Yuhang District, Hangzhou, China

电话 /Tel: 057185161516

传真 /Fax: 057188801847

网址 /Web: www.fannal.com

杭州凡诺电子有限公司是一家中外合资企业, 专注于触摸显示解决方案的综合服务提供商, 依托卓越的研发设计团队和我们的丰富行业经验, 致力于在全球范围内提供各种专业的高质量产品和技术服务。

Fannal is a comprehensive service provider specializing in touch display solutions, committed to delivering a variety of professional high-quality products and technical services globally.

**主要展品 /Products**

电子配件组装, 电容触摸屏, 液晶显示屏, 触摸显示模组, 智能触屏一体机, 触摸显示整体解决方案。touch sensors, PCAP, TFT displays, monitors, customized solutions for touch display.

**N1-1B20****杭州高瓴环境科技有限公司****Hangzhou Gaoling Environmental Technology Co., Ltd**

地址: 杭州市萧山区宁围镇新华村振新路 11 号华义塑胶办公楼 4 楼 (310000)

电话 /Tel: 4007800571

传真 /Fax: 4007800571

网址 /Web: www.amikyrm.com

**E3-3A01**

公司成立于 2016 年, 位于浙江, 杭州, 公司核心团队由美国顶尖大学的博士, 研究生以及美国高校教授作为公司发展顾问。核心团队引导公司管理, 公司产品研发, 公司渠道布局等重大决策。公司目前专注的领域为个人清洁洗护用具、口腔清洁用具, 整合国内外黑科技, 将核心卖点组成一个全新的产品。公司具备定制项目全案管理能力, 功能定义外观设计结构设计模具制作工厂生产以及未来产品的规划, 在每一个环节都能够提供优质的管家式服务。

**主要展品 /Products**

目前主营方向为: 美容美发、净水过滤、口腔护理、宠物智能

**GUANGLI****杭州光粒科技有限公司****Hangzhou Guangli Technology Co., Ltd.****W4-4A41 4A42**

地址: 浙江省杭州市西湖区华泰创业园 15 幢 A 座 6 楼

电话 /Tel: 0573-85352005

网址 /Web: www.guangli.com

光粒成立于 2017 年杭州西子湖畔, 是一家起步于光场和全息技术, 聚焦于消费级 AR 产品的国家级高新技术企业, 其使命致力于“让智能眼镜成为人类的新器官”。光粒创始团队来自浙江大学康奈尔大学和特拉华大学等国内外一流学府研发团队对核心技术自主可控有着执着的追求, 目前已掌握全产业链 220 余项中国和国际专利, 全体光粒人秉持“in light we trust 坚信光明”的信念, 为更好的未来持续提供更好的 AR 产品。

**主要展品 /Products**

Holoswim 是光粒科技旗下 AR 全息智能泳镜产品。Holoswim 具备实时记录用户游泳时的多项运动指标、AR 近眼显示数据、智能 APP 互联的功能, 可以帮助用户有效解决智能手表或手环在游泳时需要间歇抬手查看, 交互体验不好等问题, 提升运动质量。



智享橙意生活

**杭州华橙网络科技有限公司****Hangzhou Huacheng Network Technology Co., Ltd****W3-3E01**

地址: 中国 (浙江) 自由贸易试验区杭州市滨江区长河街道立业路 582 号 3 号楼 13 层 (310000)

电话 /Tel: 0571-28058299

传真 /Fax: 0571-28058299

网址 /Web: www.imou.com

杭州华橙网络科技有限公司成立于 2015 年, 同年成立面向消费端的物联网品牌——乐橙, 为数百万家庭和企业提供智能摄像机、智能门锁等众多智能家居产品。

目前, 华橙已构建了乐橙安防、乐橙互联、乐橙机器人、乐橙照明四大产品体系, 依托于乐橙 AI 能力以及乐橙云平台的支撑, 为消费者提供全场景的家居智能解决方案。

**主要展品 /Products**

Imou 乐橙面向全球民用智慧物联网市场, 构建了以 AI 技术和云技术为核心的乐橙安防、乐橙互联、乐橙机器人、乐橙照明四大产品体系。

乐橙安防: 家庭监控摄像头、智能门锁、报警套装

乐橙互联: 路由器、红外遥控器  
乐橙机器人: 洗地机、扫地机器人  
乐橙照明: 智能灯泡、智能插座  
乐橙云服务: 全球化的视频云服务平台, 为家庭, 商铺, 小微企业提供视频解决方案和视频云能力。

## HYUVC® 慧亿科技

杭州慧亿科技有限公司  
HANGZHOU HUIYI TECHNOLOGY Co., Ltd.

E2-2A43

地址: 浙江省杭州市余杭区五常大道 163 号 C 幢 3 楼 (310000)  
电话 /Tel: 0571-87995558  
传真 /Fax: 0571-85128651  
网址 /Web: www.hyuvc.com

杭州慧亿科技有限公司是一家专注于深紫外 LED 杀菌功能模块开发和各类传感器应用解决方案的研发销售一体化的现代化高新技术企业。目前已获取授权的专利共有五十余项, 公司通过国家高新技术企业认证和 ISO9001 产品质量体系认证, 多款产品通过了欧盟 CE 认证、FDA、RoHS、Reach、水批等环境和食品安全认证。公司紫外 LED 杀菌产品目前已经进入多个国内外大型家电厂商供应链系统。

### 主要展品 /Products

深紫外 LED 功能模块和各类传感器

## JIAJIBAO 家吉宝

杭州家吉宝科技有限公司

W3-3B23

地址: 杭州市滨江区华城和瑞科技广场 T3 东幢 601 室  
电话 /Tel: 4000802860

专注家居百货和家清类产品, 尤其是晾衣架产品, 致力打造美好生活日用家居百货的互联网品牌。杭州家吉宝科技有限公司作为浙江贝特日用品有限公司旗下子公司, 2005 年为欧美家居市场提供优质的产品, 服务于 B&Q /Leifheit /Daytek /Addis /Target/ Mr.Clean 等企业, 供应链实力突出, 产品丰富多样, 基础夯实。

### 主要展品 /Products

ADDIS 电动牙刷、平行落地晾衣架、X 型落地晾衣架、洗地刷、扫把套装、拖把等日用家居用品

## EUNA 优诺电器

杭州金松优诺电器有限公司

W4-4F01

Hangzhou Jinsong EUNA Electrical Appliances Co., Ltd

地址: 中国浙江省杭州市钱塘新区 3 号大街 19 号 (310012)  
Add: No.19, St.3, Hangzhou Economic & Technologic Development Area, Hangzhou, China  
电话 /Tel: 0571-28876861  
传真 /Fax: 0571-28876861  
网址 /Web: http://euna.lenj.vip/

我公司是一家集家用冰箱研发生产、销售服务于一体的专业制造型企业。公司位于杭州钱塘新区, 占地 3.7 万 m<sup>2</sup>、3 条流水线, 产能 100 万台。公司在安全性能、制冷性能等方面有 5 个型式试验室共 30 工位, 采用欧洲标准测试, 并得到 ITS、DEKRA 机构的认可。公司主营复古彩色冰箱、红酒柜、车载、房车、泡菜冰箱等差异化产品, 后期规划医用深冷冰箱、移动疫苗柜等产品。产品主要销往欧洲、北美、日韩、新加坡等国家。

Our company is a specialized manufacturing enterprise which integrates R&D, production, sales and services of refrigerators. We are located in Qiantang New Area, Hangzhou, occupies an area of 37,000 square meters, own 3 production lines and our annual output is up to 1 million sets. We have 5 type test rooms and 30 work stations in total that focused on the safety and refrigeration performances. We adopted the European Standard Test and certified by ITS and DEKRA. Our main business is retro color refrigerators, wine cabinets, car refrigerators, RV refrigerators, Kimchi refrigerators and other differentiated products. Medical refrigerators, mobile vaccine freezer, and other products will also be included in our plans. We mainly sell to developed countries like Europe, North America, Japan, Korea and Singapore.

### 主要展品 /Products

冰箱、冷柜、酒柜、冰吧、车载冰箱、房车冰箱、商用制冷产品  
home use cooling products, refrigerator, freezer, larder, wine cooler, mini fridge, mini freezer, mini bar, car fridge, commercial use cooling products

## JEAASYL

杭州钜宜科技有限公司

N3-3A52

Hangzhou Juyi Technology Co., Ltd

地址: 浙江省杭州市建德市梅城镇城南工业园何家岗路 21 号 (311604)  
Add: The Southern Industrial Development Area, Meicheng Town, Jiande City, Zhejiang, China  
电话 /Tel: 13858561183  
网址 /Web: http://hzjeasy.com/

钜宜科技有限公司致力于蒸汽清洁用品、产品的研发和制造。产品有智能快速加热节能型清洗机、蒸汽地拖、熨烫机、地毯清洁机系列等。

公司占地面积 40000 平方米, 厂房面积 30000 平方米, 拥有现代化实验室和检测设备。公司拥有多项发明专利, 产品获得了欧盟 GS、CE、EMC 以及北美 ETL 和 CQC 认证。公司秉承着“客户第一, 品质为上”的工匠精神, 欢迎新老客户来厂洽谈和进行战略合作。

Juyi technology company is committed to the development and manufacture of steam cleaning products. The products include intelligent rapid heating energy-saving cleaner, energy-saving double water tank with automatic water filling and large steam output, hand-held steam cleaner, steam drag, ironing machine, carpet cleaner series, etc.

The company covers an area of 40,000 square meters, with a workshop area of 30,000 square meters. It has modern laboratories and testing equipment and production equipment. The company has a number of invention patents, such as steam condensate reflux control has obtained international invention patents. Products have obtained the EU GS, CE, EMC, North America ETL and China CQC certification. Our company adheres to the craftsman spirit of "customer first, quality first" and the business philosophy of "striving for an industry brand", and welcome new and old customers to negotiate and carry out strategic cooperation.

### 主要展品 /Products

家庭是社会的细胞, 在疫情当下的时代, 保卫我们的家园, 守护我们的健康显得尤其重要。

KL-606 蒸汽拖把, 外观大气, 蓝色清新, 操作简单, 手杆轻松可调, 物理清洁, 快速杀菌。低重心机身设计, 整机重心在机身二分之一处以下, 轻松推行, 使用更轻盈, 告别腰酸背痛。多角度随心调, 让清洁成为享受, 多角度随心握持, 可调节拖把高度。大容量水箱 满足全屋清洁要求, 清洁面积更广, 无需反复拖, 具备更好的去污能力。



### 杭州老板电器股份有限公司

#### Robam

地址: 杭州临平区经济开发区临平大道 592 号 (311100)

电话 /Tel: 0571-89176329

传真 /Fax: 0571-89176329

网址 /Web: <https://www.robam.com/roki/roki2>

老板电器创立于 1979 年, 精耕厨电领域, 专业生产油烟机、灶具、蒸烤一体机、洗碗机、集成灶、蒸箱、电烤箱、消毒柜、微波炉、净水器、燃气热水器、冰箱等家用厨电产品。发展至今, 老板电器已成为中国厨电行业发展历史、市场份额、生产规模位列前茅的企业。老板电器始终坚持高端品牌定位, 以创新、责任、务实为纲领, 以创造人类对厨房生活的一切美好向往为使命, 致力于成为引领烹饪生活变革的世界级百年企业。

#### 主要展品 /Products

油烟机、燃气灶、电烤箱、蒸箱、蒸烤一体机、微波炉、洗碗机、集成灶  
RANGE HOOD、GAS HOB、ELECTRIC OVEN、STEAM OVEN、COMBI STEAM OVEN、  
MICROWAVE OVEN、DISHWASHER

## 直白

### 杭州乐秀电子科技有限公司

#### Hangzhou Lexiu Electronic Technology Co., Ltd.

地址: 浙江省杭州市下沙白杨街道海聚中心 1 号楼 20 楼 (310000)

Add: Haiju Center, BaiYangStreet, QianTangDistrict, HangZhou, ZheJiang

电话 /Tel: 0571-85819232

传真 /Fax: 0571-85819232

网址 /Web: <http://www.zhibai.com.cn/>

杭州乐秀电子科技有限公司, 创立于 2017 年, 是一家集“设计、研发、生产制造、营销、技术服务”五位一体的国家高新技术企业, 通过质量体系认证, 申请专利百余项, 并拥有 2 万平米的现代化制造工厂, 为用户提供科技创新、高品质、高颜值的家电产品。

旗下品牌直白, 科技养发潮领者, 专注于女性头发吹护领域, 用前沿的吹发护发科技、创新潮流的产品设计、风度不凡的个性品牌态度, 为年轻女性提供专业的头发吹护新体验。

Hangzhou Lexiu Electronic Technology Co., LTD., founded in 2017, is a collection of “design, research and development, production and manufacturing, marketing, technical services” five of the national high-tech enterprises, through the quality system certification, applied for more than

100 patents, and has 20,000 square meters of modern manufacturing plant, to provide users with scientific and technological innovation, high quality, high appearance level of household appliances.

ZHIBAI, a brand of Hangzhou Lexiu, Focusing on the field of female hair blowing care, with cutting-edge hair blowing care technology, innovative product design, elegant personality brand attitude, to provide young women with professional hair blowing care new experience.

#### 主要展品 /Products

公司深入布局个人美健电器产品线, 创新创造包含了高速吹风机、水离子吹风机、正负双离子吹风机、风塑卷发棒、直发器、电动牙刷等在内的优势品类产品。

ZHIBAI in-depth layout of personal beauty health electrical product line, innovation and creation of high-speed hair dryer, water ion hair dryer, positive and negative dual ion hair dryer, wind plastic curling iron, hair straightener, electric toothbrush and other advantageous products.

## MQ名气

### 杭州名气电器有限公司

#### HANGZHOU MQ APPLIANCES CO.,LTD.

地址: 浙江省杭州市临平区塘宁路 9 号 (311100)

Add: No. 9, Tangning Road, Linping District, Hangzhou City, Zhejiang Province

电话 /Tel: 0571-86189121

传真 /Fax: 0571-86189121

网址 /Web: <http://www.mqkitchen.com/>

名气电器, 以“创造人类对厨房生活的一切美好向往”为企业使命, 致力于打造兼具美和技术的高性价比的产品。2020 年, 基于消费升级的大背景, 满足人民日益提高的物质需要, 名气电器领先探索并构建了厨电行业的全新消费模式 - 名气现代厨房, 为消费者提供多产品、全场景、一站式的购物新体验。

Mingqi electric, with the mission of “creating all the beautiful yearnings of human beings for kitchen life”, is committed to creating high-cost products with both beauty and technology. In 2020, based on the background of consumption upgrading and meeting the increasing material needs of the people, Mingqi electrical appliances took the lead in exploring and building a new consumption mode of kitchen electricity industry - Mingqi modern kitchen, providing consumers with a new shopping experience of multi products, full scene and one-stop shopping.

#### 主要展品 /Products

橱柜、集成灶、油烟机、灶具、消毒柜、洗碗机、集成洗碗机、蒸箱、烤箱、蒸烤一体机、净水机、燃气热水器、热饮机

Cabinet, integrated stove, range hood, stove, disinfection cabinet, dishwasher, integrated dishwasher, steamer, oven, integrated steamer, water purifier, gas water heater, hot drink machine



钱江制冷集团

杭州钱江制冷压缩机集团有限公司

Hangzhou Qianjiang Refrigeration Compressor Group Co., Ltd.

W2-2E81

地址: 浙江省杭州市余杭区圣西路一号 (311100)

Add: No.1 Shengdi road, Xianlin, Yuhang, Hangzhou, P.R. China

电话 /Tel: 0571-88685630

网址 /Web: http://www.qjzl.com/

杭州钱江制冷压缩机集团有限公司专注于研发、生产、销售万胜“WANSHENG”牌全封闭制冷压缩机 30 多年, 产品被广泛应用于冰箱、冷柜、厨房柜、制冰机、除湿机、饮水机、各类商用柜等制冷器具。目前是国内最大的民营压缩机生产厂家, 具备日产 10 万台, 年产 3000 万台压缩机的生产能力, 目前, 公司已具备年生产 3000 万台以上压缩机的能力, 全球累计销量突破 3 亿台, 产销量连续 8 年稳居全国行业前三、力争全球第三。

Hangzhou Qianjiang Refrigeration Compressor Group Co., Ltd. focuses on research and development, production and sales of "WANSHENG" brand fully enclosed refrigeration compressors for more than 30 years, the products are widely used in refrigerators, freezers, kitchen cabinets, ice makers, dehumidifiers, water dispensers, all kinds of commercial cabinets and other refrigeration appliances. At present, it is the largest private compressor manufacturer in China, with the production capacity of 100,000 units per day and 30 million units per year. Currently the company has the productive capacity over 30 million compressors annually. The accumulated productive capacity and sales volume have reached 300 million units. The productive capacity and sales volume of compressors have continuously ranked at the third place in Chinese refrigeration industry for the past eight years, which lay a solid foundation for creating a global R&D and production base of national-brand compressors.

## 主要展品 /Products

全封闭式制冷压缩机

hermetic compressors for refrigerators

R

DESIGN

瑞德设计

杭州瑞德设计股份有限公司

Hangzhou RE&amp;DER DESIGN Co., Ltd

E3-3G71

地址: 浙江省杭州市滨江区腾龙路 268 号 (311600)

Add: 268 Tenglong Road, Binjiang District, Hangzhou City, Zhejiang Province, China

电话 /Tel: 0571-56135888

传真 /Fax: 0571-56135888

网址 /Web: www.rddesign.cc

杭州瑞德设计股份有限公司创立于 1999 年, 是国家级工业设计中心、中国十佳设计机构, 拥有 300+ 创新人才, 荣获 450+ 项国际设计大奖。2014 年在全国股转系统挂牌上市并蝉联创新层 (股票代码: 瑞德设计 股票代码: 831248)。瑞德设计以产品设计、空间设计、品牌策划设计为创新引擎, 二十多

年来成功完成 2000 多个超级案例, 为客户创造 3000 多亿元的社会价值, 用超级设计成就中国企业高端化。

Hangzhou Reed Design Co., Ltd. was founded in 1999, is a national industrial design center, China's top ten design institutions, has 300+ innovative talents, won 450+ international design awards. In 2014, it was listed in the National Stock transfer System and successively ranked in the innovation tier (stock abbreviation: Red Design stock code: 831248). With product design, space design, brand planning and design as the innovation engine, Red Design has successfully completed more than 2000 super cases in more than 20 years, creating more than 300 billion yuan of social value for customers, and achieving high-end Chinese enterprises with super design.

## 主要展品 /Products

产品设计、空间设计、品牌设计

product design, space design, brand planning design

SICN<sup>®</sup> 三创

杭州三创有机硅有限公司

HANGZHOU SICN ORGANOSILICONE CO., LTD.

N2-2A23

地址: 杭州市临平区南公河路 1 号 5 幢 1-2 层

电话 /Tel: 18868891259

杭州三创有机硅有限公司成立于 2014 年底, 为国家科技部认定的国家高新技术企业和浙江省科技厅认定的浙江省科技型中小企业, 为中国氟硅协会和浙江省有机硅材料行业协会的会员单位。公司致力于研发有机硅材料应用体系, 目前已研发生产四大系列产品: 各种结构和规格的硅胶管、各种规格的硅胶密封条、硅胶终端消费品和有机硅材料, 为客户提供全面的解决方案。

## 主要展品 /Products

食品级硅胶管、医疗级硅胶管、工业级硅胶管、硅胶蠕动泵管、硅胶编织管、发泡硅胶管、冷缩套管、硅胶密封条、发泡硅胶密封条、硅胶模压件等

SILAN

杭州士兰微电子股份有限公司

HANGZHOU SILAN MICROELECTRONICS CO., LTD

W1-1A20

地址: 杭州市黄姑山路 4 号 (310012)

电话 /Tel: 86-0571-88210880

网址 /Web: www.silan.com.cn

士兰微电子成立于 1997 年 9 月, 总部在中国杭州。2003 年 3 月公司股票在上海证券交易所挂牌交易 (上交所: 600460), 成为第一家在中国境内上市的集成电路芯片设计企业。士兰微电子专注于半导体集成电路设计与芯片制造产业以及高亮度 LED 芯片的制造, 建有 5/6/8 英寸芯片生产线, 同时在建 2 条 12 吋特色工艺晶圆生产线和 1 条先进化合物半导体器件生产线, 向客户提供高质量的集成电路和分立器件和 LED 产品。

Silan Microelectronics was founded in 1997 and listed in Shanghai Stock Exchange in 2003. It is the biggest IDM semiconductors company in China, running 5" /6" /8" three Fabs, two



packaging factories and one testing factory. In Dec 2017, Silan officially announced to start building two more 12 inch Fabs in Xiamen, Fujian province, China.

#### 主要展品 /Products

1. 基于士兰芯片生产线高压、高功率、高频特殊工艺的集成电路、功率模块 (IPM/PIM)、功率器件及 (各类 MCU/ 专用 IC 组成的) 功率半导体方案
  2. MEMS 传感器产品、数字音视频和智能语音产品、通用 ASIC 电路
  3. 光电产品及 LED 芯片制造和封装 (含户内外彩屏和 LED 照明)
- 1.ICs, Power Module(IPM/ PIM), Discrete Devices and kinds of MCU/ IC power semiconductor solutions based on Silan' s own special process of high voltage, high power and high frequency.
- 2.MEMS sensors, Digital audio SoC and speech recognition, General ASIC
- 3.Optoelectronic products, LED chip Manufacturing and packaging (for indoor and outdoor LED display panel as well as LED illumination applications)



#### 杭州涂鸦信息技术有限公司

W3-3E81

#### HangZhou Tuya Information Technology CO., LTD

地址: 杭州市西湖区蒋墩路华策中心 A 座 2-3 层、6-13 层 (310000)

Add: 2-3th, 6-13th Floor, Building A, Huace Center, Jiangdun Road, Xihu District, Hangzhou, Zhejiang Province, China

电话 /Tel: 400-881-8611

传真 /Fax: 400-881-8611

网址 /Web: www.tuya.com

涂鸦智能 (NYSE: TUYA) 是一家致力于让生活更智能的领先技术公司, 涂鸦提供能够智连万物的云平台, 打造互联互通的开发标准, 连接品牌、OEM 厂商、开发者、零售商和各行业的智能化需求, 涂鸦的解决方案赋能并提升合作伙伴和客户的产品价值, 同时通过技术应用使消费者的生活更加便利, 涂鸦智能的智慧商业 SaaS 为丰富的垂直行业提供智能解决方案。涂鸦智能领先业界的技术, 符合严格的数据保护标准和安全性。

Tuya Smart (NYSE: TUYA) is a leading technology company focused on making our lives smarter. Tuya does this through offering a cloud platform that connects a range of devices via the IoT. By building interconnectivity standards, Tuya bridges the intelligent needs of brands, OEMs, developers, and retail chains across a broad range of smart devices and industries. Tuya solutions empower partners and customers by improving the value of their products while making consumers' lives more convenient through the application of technology. Through its growing commercial SaaS business, Tuya offers intelligent business solutions for a wide range of verticals. The Company' s platform is backed by industry-leading technology complete with rigorous data protection and security.

#### 主要展品 /Products

大家电、小家电、厨房电器、宠物、电工、照明、传感、清洁机器人、摄像机、智能锁、网关中控、节能能源、数码娱乐、户外出行、健康

Major Appliance, Small Appliance, Kitchen Appliance, Pets, Electrical, Lighting, Sensor, Cleaning Robot, Camera, Smart Lock, Gateway, Energy-Saving, Entertainment, Outdoor Travel, Health

## SIMTONE

杭州·西蒙

### 杭州西蒙电器有限公司

N2-2A17

#### Hangzhou Simtone Electric Co., Ltd.

地址: 浙江省杭州市萧山区经济技术开发区市中心北路 108 号 (311200)

电话 /Tel: 4000880398

传真 /Fax: 0571-82751971

网址 /Web: www.hz-simtone.com

杭州西蒙电器有限公司是具有较强产品开发能力的科技型企业, 通过了“高新技术企业”认证、国家专利认证、绿色供应认证、售后服务认证, 被认定为浙江省科技型企业、AAA 级信用企业, 经过专家组审核, 通过了 ISO9001 质量管理认证、ISO14001 环境管理认证、ISO45001 安全管理认证, 经中国平安“平安保险投保”, 以良好的信誉、求实的作风, 优质的产品和服务赢得了广大客户和业内同仁的认可。

The company has been insisting for decades, won the affirmation and recognition of the market and relevant organizational departments, is a science and technology enterprise with strong product development capabilities, passed the "high-tech enterprise" certification, national patent certification, green supply certification, after-sales service certification, was identified as Zhejiang science and technology enterprises, AAA credit enterprises, after the expert group review, passed ISO9001 quality management certification, ISO14001 environmental management certification, ISO45001 safety management certification, by China Ping An "Ping An Insurance Application", with good reputation, realistic style, high-quality products and services have won the recognition of customers and colleagues in the industry, both production and sales are at the forefront of the industry, actively promote the standardized development of the industry, and make greater contributions to the society!

#### 主要展品 /Products

排油烟气防火止回阀 G9, 排油烟气止回阀 C7, 排油烟气止回阀 C8, 排油烟气止回阀 C9, 燃气管, 波纹管, 转换接头, 烟机支架, 角阀

Oil exhaust flue gas fire check valve G9, oil exhaust flue gas check valve C7, oil exhaust flue gas check valve C8, oil exhaust flue gas check valve C9, gas pipe, bellows, adapter joint, hood bracket, angle valve



### 杭州向田电器有限公司

N3-3A08

地址: 浙江省杭州市萧山区经济技术开发区桥南区块鸿兴路 393

电话 /Tel: 15738816557

网址 /Web: www.sungtang.cn

向田作为中国电饭煲 (类蒸汽饭煲) 发明人, 立志于“中国米饭的味道, 让每个家庭吃上健康的蒸米饭”, 现已拥有 30 项国内国际专利, 其中有 6 项国内发明专利。向田注重“全链条质量服务”的理念, 包含产品开发、设计、制造、销售、服务整个链条经验, 旗下拥有“Sungtang”和“向田”2 大自主品牌。

#### 主要展品 /Products

电饭煲 XT-40ZD01, XT-40ZD02, XT-401 等等



### 杭州星帅尔电器股份有限公司

#### Hangzhou Star Shuaier Electric Appliance Co., Ltd.

W2-2C81

地址: 浙江省杭州市富阳区受降镇交界岭 99 号 (311422)

Add: No.99 Jiao Jie Ling, Shou Xiang Town, Fuyang Hangzhou, China.

电话 /Tel: 0086-571-63410817

传真 /Fax: 0086-571-63410816

网址 /Web: www.hzstarshuaier.com

杭州星帅尔电器股份有限公司是一家专业从事研发、生产和销售各类继电器的高新技术企业,公司于 2017 年 4 月 12 日在深圳证券交易所成功挂牌上市(股票代码: 002860)。公司产品约占国内市场近 1/3,成为国内压缩机两器生产和出口的主要基地。公司具备完善的质量管理体系,并作为组长单位组织或参与了多项国家(行业)相关标准的制定。

Hangzhou Star Shuaier Electric Appliance Co.,Ltd is a high-tech enterprise specializing in R&D,manufacturing and the sales of various relays.The company listed successfully on Shenzhen Small and Medium Enterprise Board on April 12th,2017(stock code:002860).

Star Suaier occupies the approx.1/3 domestic marketing share of both the protectors and relays for compressors, and has also become the main base for the manufacturing and exporting of the protectors&starting relays.

Star Shuaier has a perfect quality management system, Star Shuaier is also the the leader enterprise to organize or participate in formulation of the related national (industrial) standards.

#### 主要展品 /Products

压缩机用热保护器、起动机

Overload Protector and Start Relay for Compressor



### 杭州英乐特智能科技有限公司

#### Hangzhou IELIET Intelligent Technology Co., Ltd

E1-1C61

地址: 中国(浙江)自由贸易试验区杭州市钱塘区新加坡科技园 2 幢 806 (311199)

Add: China (Zhejiang) Pilot Free Trade Zone, Hangzhou Qiantang District, Singapore Science park building 2 806

电话 /Tel: 400-180-1981

传真 /Fax: 0571-57575888

网址 /Web: www.yinglete.com

英乐特,中国高端智能技术开发者、智能机器人制造商、智能家居产品服务商。总部位于杭州市大江东产业集聚区,是国家级高新技术企业。研发中心与智能与智能制造中心设立于杭州经济技术开发区。产品覆盖服务机器人、智能家电控制器等领域。

Yingle, China's high-end intelligent technology developer, intelligent robot manufacturer, intelligent home products service provider. Headquartered in Hangzhou Dajiangdong Industrial agglomeration Zone, is a state-level high-tech enterprise. The R&D center and intelligent manufacturing Center are located in Hangzhou Economic and Technological Development Zone.

The products cover service robots, intelligent home appliance controllers and other fields.

#### 主要展品 /Products

公司主要产品为 S01、Q01 两款扫拖机器人。S01 款扫拖机器人是以纯拖为主的,具有低噪声、高效拖地、一键清洗拖布、加压拖地等核心功能。运行噪声低于 45dB,可持续工作 120min。

Q01 是一款具有扫拖吸烘功能的双基站一体式机器人,是我司高端创新产品,已有相关 36 项发明专利和 45 项实用新型专利。具有双滚拖清洗甩干、尘盒颗粒分离过滤、污水箱水过滤、双滚拖缩小沿边距离等优势功能。

The company's main products are C01, Q01 two sweeping robot, C01 sweeping robot is mainly pure dragging, with low noise, efficient mop, one-button cleaning mop, pressure mop and other core functions. The operating noise is lower than 58dB, the battery capacity is 2600mAh, the sustainable work is 150min, the water tank capacity is 380ml for continuous wet drag for 90min. Q01 is a double base station integrated robot with the function of sweeping, dragging, sucking and drying. Double base station sweeping and towing all-in-one machine belongs to our high-end innovative products. At present, 36 invention patents and 45 utility model patents have been applied. It has the advantages of double roll-drag cleaning and spin-dry, dust box size particle separation and filtration, sewage tank water filtration, double roll-drag to reduce the edge distance and so on.

## Unitree

### 宇树科技

#### 杭州宇树科技

#### Unitree Robotics

W3-3B11

地址: 浙江省杭州市滨江区西兴街道东流路 88 号 1 幢 (310051)

Add: Building 1, 88 Dongliu Road, Binjiang District, Hangzhou, China

电话 /Tel: 0571-56716562

网址 /Web: https://www.unitree.com/

杭州宇树科技有限公司专注于消费级、行业级高性能四足机器人的研发、生产及销售,是世界机器人圈知名初创公司。作为国内四足机器人厂商中第一也是唯一通过欧洲 CE, 北美 FCC, 日本 PSE 等质量强制认证的公司,宇树科技在运动控制、计算机视觉、深度强化学习等领域持续保持领先,相继受到英国 BBC、央视新闻联播等采访报道。宇树科技也是全球首家公开零售高性能四足机器人的公司,并且销量领先。

Unitree Robotics is a well-known start-up company in the world of robotics that focuses on the development, production and sales of consumer-level and industry-level high-performance quadruped robots. We have been invited to participate in the CCTV Spring Festival Gala in the 2021 Year of the Ox, and also have been interviewed and reported by the British BBC and CCTV News Network. Unitree Robotics is the world's first company to publicly retail high-performance quadruped robots and leads global sales.

#### 主要展品 /Products

宇树 PUMP 健身泵——口袋里的专业健身房!

PUMP 核心动力~源自机器人关节力控技术,颠覆传统健身器械;它是电阻划船机,也是仅 700g 的龙门架,更是小巧百变的健身泵,力量任你调节,智能记录运动数据,更有海量免费教程。宇树 PUMP 健身泵,黑科技助力全民健身热潮,正式推动智能运动健身进入新时代,让智能数字健身成为一种轻松科学的生活方式!

Supported by the force control technology of robot joint, PUMP has strong core power. You can work out anytime and anywhere you want and it can provide you a short-term, efficient and scientific mode. The futuristic tech will promote the fitness craze to sweep the country, officially promoting intelligent fitness into a new era, and make intelligent digital fitness an easy and scientific way of life!

## Tasteplus 悦味

杭州悦味家居有限公司  
Hangzhou Yuewei Household co.,ltd

N3-3A24 3A25

地址: 浙江省杭州市拱墅区丽水路 166 号 124 幢 F20-1 室 (310011)  
Add: F20 store, No.166, Lishui Road, Gongshu district, Hangzhou  
电话 /Tel: 0571-88258627  
传真 /Fax: 0571-88258627  
网址 /Web: www.taste-plus.com

悦味成立于 2015 年所有的产品均是悦味团队自主研发, 精心设计, 不断改良的成果。我们有 20 多年服务国际一线品牌的经验, 因为热爱, 我们不忘初心, 力求突破, 致力于家庭厨具的人性化设计。我们希望通过更好的设计, 让厨房更精致, 更有调, 让更多人爱上厨房, 享受烹饪。

taste plus is founded in 2015

### 主要展品 /Products

元木系列  
motoki series



杭州洲钜电子科技有限公司  
HANGZHOU ZHOUJU ELECTRONIC TECHNICAL CO.,LTD

N4-4B18

地址: www.sptchina.cn (311122)  
电话 /Tel: 0571-88539881  
网址 /Web: www.sptchina.cn

杭州洲钜电子科技有限公司成立于 2010 年, 致力于直流无刷电机变频驱动、控制领域的研究, 掌握理论、系统、软硬件研发及制造、销售为一体的高新技术企业。产品已涵盖电机驱动、空调、冰箱、厨卫、水处理等多个领域。主要在直流无刷电机变频驱动和控制等技术及应用行业, 向 5W—30KW 电机、直流变频压缩机及应用的相关家电整机产品、混合动力汽车等客户提供理论算法、驱动、运行控制、整机系统、分析测试仪表设备等技术。

Hangzhou Zhouju Electronic Technological Co.,Ltd. located in leisure City--Hangzhou, mainly research and develop, manufacture and distribute BLDC Driver &controller. It covers about 10000 square meters and has 300 Employees;among of more than 60 engineers with exquisite technique and rich experience in BLDC driver.

The 2018 annual amount is about RMB 200Billion .  
Zhouju is approved by ISO9001.IS014001 and OHSAS18001, and have the certification of National High-Technology Enterprise and Municipal Level R&D department Center of High Technology Enterprise.

### 主要展品 /Products

变频压缩机驱动, 变频直流电机驱动, 变频风机驱动, 直流水泵驱动, 集成灶等家用电器驱动控制  
Compressor driver, BLDC Motor Driver, BLDC Fan Driver, BLDC water pump driver, Integrated oven driver and controller



好利来 (厦门) 电路保护科技有限公司  
Hollyland (Xiamen) Technology Corporation Limited

W1-1A46

地址: 福建厦门市翔安区舫山东二路 829 号 (361101)  
Add: 829, Fangshan East 2nd Road, Xiang'an, Xiamen, China.  
电话 /Tel: 0592-5772288  
传真 /Fax: 0592-5773979  
网址 /Web: www.hollyfuse.com

好利来 (厦门) 电路保护科技有限公司, 主营熔断器等电路保护元器件业务。是专业研发、生产、销售电路保护器产品的高新技术企业。公司拥有 30 多年的电路保护器设计、制造经验。产品包括小型熔断器、微型熔断器、SMD 熔断器、温度保险丝、高 / 低压熔断器及自复保险丝等电路保护器, 广泛应用于通讯、计算机、交通、玩具、家用电器、电池、新能源及其它电子电力系统保护。

### 主要展品 /Products

产品包括小型熔断器、微型熔断器、SMD 熔断器、温度保险丝、高 / 低压熔断器及自复保险丝等电路保护器, 广泛应用于通讯、计算机、交通、玩具、家用电器、电池、新能源及其它电子电力系统保护。

和正®  
HEZHENG

合肥和正医疗科技有限公司  
Hefei Hezheng Medical Technology CO.,Ltd

E2-2B02 E3-3D73 3D74

地址: 合肥市包河区兰州路 88 号安徽青年电子商务工业园 A 座 5 层东南区  
电话 /Tel: 15555175882

合肥和正医疗科技有限公司成立于 2009 年, 是国家级高新技术企业, 厂房占地面积 5000 平方米; 我们有专业的研发团队, 并获得 150 多项专利技术, 其中发明专利有 20 项, (我们秉承“质量第一、诚信为本、顾客满意、持续改进”的质量方针, 专注于健康按摩器的研发、生产、销售已有 12 年, 公司已通过 ISO14001/ISO9001/OHSAS18001 体系认证, 产品通过美国 FDA,FCC,CE,ROHS 等。

### 主要展品 /Products

多维度头部按摩器, 膝盖按摩器, 眼部按摩器, 腰部按摩器, 腹部按摩器, 足底按摩器, 筋膜枪  
HEAD MASSAGER, KNEE MASSAGER, EYE MASSAGER, WAIST MASSAGER, BELLY MASSAGE, FOOT MASSAGER, MASSAGE GUN



— 福申传感 —

**河南福申电子科技有限公司****Henan Fosen Electronics Technology Co., Ltd.****W3-3H71**

地址: 河南省郑州市航空港区如云路恒丰科创中心 7 号楼 7 层

Add: Hengfeng Kechuang Center, Ruyun Road, Zhengzhou Aviation Port Area,  
Zhengzhou City, Henan Province

电话 /Tel: 0371-86630636

网址 /Web: www.hnfosen.com

河南福申电子科技有限公司是一家从事智能气体传感器的国家高新技术企业。形成了光学(红外、激光等)、电化学、MEMS 半导体、固体电解质等原理的气体传感技术平台。公司拥有雄厚的研发实力,目前拥有发明及实用新型专利 100 余项,软件著作权 10 余项。已获得《国家高新技术企业》、《国家科技型企业》、《河南省科技型企业》、《郑州市专精特新企业》、《郑州市科技型企业》、《郑州航空港区先进企业》等荣誉。

Henan Fosen Electronics Technology Co., Ltd. is a national high-tech enterprise engaged in intelligent gas sensors. A gas sensing technology platform based on the principles of optics (infrared, laser, etc.), electrochemistry, MEMS semiconductor, and solid electrolyte has been formed. The company has strong research and development strength, currently has more than 100 invention and utility model patents, and more than 10 software copyrights. Has won the "National High-tech Enterprise", "National Science and Technology Enterprise", "Henan Province Science and Technology Enterprise", "Zhengzhou Specialized, Refinement, Differential and Innovation Enterprise", "Zhengzhou Science and Technology Enterprise", "Advanced Enterprise in Zhengzhou Airport Area", etc.

**主要展品 /Products**

激光粉尘传感器系列、甲醛传感器系列、二氧化碳传感器系列、TVOC 传感器、特殊气体传感器系列、多参数气体传感器集成、动力电池 / 储能电站热失控报警监测、空气质量检测仪、气体浓度检测仪等。

Laser dust sensor, Formaldehyde sensor, Carbon dioxide sensor, TVOC sensor, Special gas sensor series, Multi-parameter gas sensor integration, Thermal runaway alarm monitoring for power battery/storage power station, Air quality detector, Gas concentration detector, etc.

**河南三元光电科技有限公司****HE NAN SAN YUAN PHOTOELECTRLC TECHNOLOGY CO.LTD****E2-2H81**

地址: 河南光山官渡和产业集聚区三元远红外电子电器产业园

电话 /Tel: 0376-8865898

传真 /Fax: 0376-8865898

网址 /Web: www.sanra.cn

三元光电是国家级高新技术企业, ISO9001 质量管理体系和 ISO14001 环境体系认证企业。创新是三元光电的基石, 作为新型电热行业的领创者, 三元始终保持在行业科技创新的前沿, 于 2009 年

6月成立光山县电热应用研究所, 建立电热物理实验室, 2016 年成立省级远红外应用技术研究中心, 2021 年与上海交大正式签约, 成立远红外应用技术研究中心和蓄热储能研究中心。目前专业从事高温远红外辐热技术及产品研究。

Sanyuan optoelectronics is a national high-tech enterprise with ISO9001 quality management system and ISO14001 environmental system certification. Innovation is the cornerstone of Sanyuan optoelectronics. As a leader in the new electrothermal industry, Sanyuan has always been at the forefront of scientific and technological innovation in the industry. Guangshan electrothermal Application Research Institute and electrothermal physics laboratory were established in June 2009, and the provincial far infrared application technology research center was established in 2016. In 2021, Sanyuan officially signed a contract with Shanghai Jiaotong University, Establish far infrared application technology research center and heat and energy storage research center.

**主要展品 /Products**

河南三元光电科技有限公司(企业股权代码: 206972), 始建于 1999 年 8 月, 注册资金 5000 万元, 公司位于河南光山官渡河产业集聚区, 专业研发、生产、销售新型环保节能电热产品, 主营产品有远红外智能电子家具、远红外健康厨房电器、远红外电取暖器系列、远红外辐射式无烟烧烤设备、静电油烟净化设备、农林渔牧产业室内升温设备等系列产品以及高端养生茶壶和远红外茶炉等 120 多个品种。

Henan Sanyuan Photoelectric Technology Co., Ltd. (Enterprise Equity Code: 206972), founded in August 1999 with a registered capital of 50 million yuan, is located in guanduhe industrial agglomeration area, Guangshan, Henan Province. The company specializes in the R & D, production and sales of new environmental protection and energy-saving electric heating products. Its main products include far-infrared intelligent electronic furniture, far-infrared health kitchen appliances, far-infrared electric heater series Far infrared radiant smoke-free barbecue equipment, electrostatic fume purification equipment, indoor heating equipment for agriculture, forestry, fishery and animal husbandry industry, as well as more than 120 products such as high-end health preserving teapots and far-infrared tea stoves.

**河源市信大石英电气有限公司****HeYuan XinDa quartz electric appliance Co.,Ltd.****W2-2A03**

地址: 河源市江东新区经济开发试验区临江工业园内 (517000)

Add: Linjiang industrial park,jiangdong, 517000 Heyuan, Guangdong province, China.

电话 /Tel: 0762-3269222

传真 /Fax: 0762-3269186

河源市信大石英电器有限公司, 从 1988 年开始从事石英管、发热丝的生产, 是全球领先的石英管、发热丝和石英加热管制造商。

公司始终坚持集自主研发、生产、销售、服务全产业链系列为一体的现代化制造企业。自主品牌为 "Sundear" 电暖器。

同时是美的、格兰士、松下、惠而浦、九阳等国际著名品牌 OEM 电热配件的战略合作伙伴。产品远销亚、非、欧、美一百余个国家和地区, 现有专利 40 余项, 产品质量深受顾客的好评。

Sundear has experienced a lot of changes in the past 30 years and we take great pride in our growth.



What started as a small workshop in Heyuan City, Guangdong Province has become a world center for exceptional products.

We provide heating solutions for worldwide manufacturers. We are the GUANGDONG PROVINCE HIGH TECH COMPANY, and GUANGDONG ENGINEERING TECHNOLOGY RESEARCH CENTER of far-infrared radiation devices with high-efficiency & energy-saving.

Our mission is to keep developing, innovating, and producing quality infrared heating products.

#### 主要展品 /Products

发热丝、石英玻璃管、石英发热管各种发热管、户外取暖器

Heating wire, quartz glass tube, quartz heating tube, various heating tubes, outdoor heater



恒富电机

#### 鹤山市恒富微型电机有限公司

#### HESHAN CITY HENG FU MICRO MOTOR CO., LTD

N3-3B57

地址: 广东省鹤山市雅瑶镇朝阳工业路 5 号 (529724)

电话 /Tel: 86-750-8284738

传真 /Fax: 86-750-8287443

网址 /Web: www.hshengfu.com

鹤山市恒富微型电机有限公司是一家专业的电机高新技术企业, 集研发、设计、生产、销售于一体的企业。主要生产单相串励电动机、直流电动机、罩极电动机、无刷电动机等。广泛用于吸尘器、洗地机、厨房电器等领域。公司拥有雄厚的技术积累和专业的研发团队及先进的现代化生产设备。一直以来, 公司大力的投入永磁无刷、变频无刷和开关磁组无刷电机的研发, 目前已有 BL90 系列、BL9530 系列、BLF9530 系列多款产品上市。

HESHAN CITY HENG FU MICRO MOTOR CO., LTD is a High & New Technological Enterprise, The company integrates R&D, design, production and sales. It mainly produces single-phase series motor, DC motor, Shaded pole motor, brushless motor, etc. Widely used in vacuum cleaner, Electric Floor Washer, Home appliances and other fields.

Our company has strong technology accumulation, professional R&D team and advanced modern production equipment. Over the years. The company devotes great efforts to the research and development of permanent magnet brushless motor, frequency converter brushless motor and switched magnetic brushless motors. nowadays, there are BL90 series, BL9530 series and BLF9530 series on the market. With high quality products, adhering to the concept of "customer satisfaction is our pursuit", the company cooperates with domestic and foreign businessmen with star-rated marketing service quality for common development.

#### 主要展品 /Products

单相串励电动机、直流电动机、罩极电动机、无刷电动机、吸尘器电机, 破壁机电机, 榨汁机电机



#### 恒洁卫浴集团有限公司

#### Guangdong HEGII Sanitary Wares Co., Ltd.

N1-1C01 1C11

地址: 广东省佛山市禅城区季华二路智慧新城 T5 栋 2-4 层 (528000)

Add: F2-4, Building T5, Zhihuixincheng, Jihua No.2 Road, Chancheng District, Foshan City, Guangdong Province

电话 /Tel: 400-833-1350

传真 /Fax: 0757-29977909

网址 /Web: https://www.hegii.com

恒洁创立于 1998 年, 一直专注于卫浴产品及卫浴空间解决方案的研发和生产。恒洁肩负“专注品质、持续创新、倡导环保, 致力于通过产品与服务, 创造品质美好生活。”的品牌使命, 始终如一地提供高品质产品与服务。凭借持续创新、品质卓越、优质服务的核心竞争力, 迅速发展成为国内市场的领导品牌。

Founded in 1998, HEGII Sanitary Ware Group Co., Ltd. is a professional brand that provides a series of sanitary product development, production, sales and services. HEGII has five major categories of production including smart products, ceramic sanitary ware, bathroom cabinets, hardware faucets, shower rooms and bathtubs. base.

#### 主要展品 /Products

恒洁全系列明星产品:

高智商高情商, 搭载一键旋钮、活水即热、水流能冲水、智能翻盖、恒净除菌系统等多项核心技术的智能双 Q 坐便器;

开创 3.5L 超节水时代的超旋风坐便器;

“温润如木, 坚韧如金”的“木合金”系列浴室柜;

超大平台的新翼 T 系列平台花洒; 即买即装的易至淋浴房;

随心舒适、量身定制的 Rico 及百变系列龙头……

为消费者带来健康、安全、舒适、便捷的使用体验。

Smart toilet



#### 红品晶英科技 (深圳) 有限公司

#### Hongpin Jingying Technology (Shenzhen) Co., Ltd.

W1-1D91

地址: 广东省深圳市宝安区福永街道凤凰社区腾丰大道 176 号 (518103)

电话 /Tel: 0755-33931388

传真 /Fax: 0755-33931570

网址 /Web: www.honpe.com

HONPE 创建于 1999 年, 专业制作各种数码产品模型、汽车模型、家电模型、以及金属零部件的加工和制作。目前厂占地面积 30000 平方米, 有各种 CNC 加工中心 350 台, 五轴加工中心 25 台, 员工 1500 人, 独立电镀氧化、皮套制作、打磨抛光、喷油配色、镭雕丝印、复模车间以及其它模型制作所需要的完整的配套设备。专业的国际化设计、研发团队可协同客户完成最优方案制定, 快速完成原型机、功能机制作。

Hongpin Jingying Technology (Shenzhen) Co., Ltd. was founded in 1999, specializing in the

production of various digital product models, automotive models, household appliances models, as well as the processing and manufacturing of metal parts. At present, the factory covers an area of 30,000 square meters, there are 350 CNC machining centers, 25 five-axis machining centers, 1500 employees, have their own electroplating oxidation plant, leather production workshop, and other model production needs of complete supporting equipment.

#### 主要展品 /Products

专业制作各种数码产品模型、汽车模型、家电模型、以及金属零部件的加工和制作。目前厂房占地面积 30000 平方米, 有各种 CNC 加工中心 350 台, 五轴加工中心 25 台, 员工 1500 人, 独立电镀氧化、皮套制作、打磨抛光、喷漆上色、镭雕丝印、复模车间以及其它模型制作所需要的完整的配套设备。

Specializing in the production of various digital product models, automotive models, household appliances models, as well as the processing and manufacturing of metal parts. At present, the factory covers an area of 30,000 square meters, there are 350 CNC machining centers, 25 five-axis machining centers, 1500 employees, have their own electroplating oxidation plant, leather production workshop, and other model production needs of complete supporting equipment.



#### 厚联环境科技(上海)有限公司 Holarn Environmental Technology

W5-5B40

地址: 上海奉贤区张翁庙路 525 号  
电话 /Tel: 13601762976

厚联公司将等离子体技术与微静电技术融为一体, 具备了极高的空气消毒净化功能, 经国家权威实验室认证, 在额定风量下, 微生物一次净化率达到 96%, pm2.5 一次净化率达到 95%; 按空气消毒机标准测试, 白葡萄菌杀灭率达到 99.99%, 自然菌杀灭率达到 99.6%。

厚联公司承诺, 专注于等离子体微静电一体化消毒净化模块与空调系统消毒净化设备 OEM 代工领域, 不会以自有品牌进入空气消毒机、空气净化器市场。

#### 主要展品 /Products

等离子体微静电过滤器; 回风口空气消毒净化器、空调箱空气消毒净化器、风管式空气消毒净化器

#### DIISEA®滴水

#### 湖北滴水科技有限公司 Hubei Diisea Technology Co., Ltd

E1-1H61

地址: 武汉市江夏区腾讯大道中关村信息谷 4 号楼 16 层 (430200)  
Add: 16th Floor, Building 4, Information Valley, Zhongguancun, Tengxun Avenue,  
Jiangxia District, Wuhan City  
电话 /Tel: 15602868688  
网址 /Web: <https://www.diisea.com/>

滴水科技 (DIISEA) 是一家专注于智能清洁领域, 集研发、制造、销售、服务于一体的国家高新技术企业。滴水开创水尘环流技术, 全球范围布局专利近 350 项, 是水尘洗地机开创者, 国家洗地机标准制定主要参与方。同时滴水也是母婴级洗地机标准制定者。未来, 滴水科技将持续探索和开发更高效的清洁技术、产品来解决各个领域的清洁痛点, 力争用十年时间, 让滴水科技代表中国原创, 成为全

#### 球智能清洁领域的领先者!

Hubei Diisea Technology Co., Ltd (DIISEA) is a national high-tech enterprise specializing in intelligent cleaning, integrating research & development, manufacturing, sales, and service. DIISEA pioneered the water dust circulation technology, with nearly 350 patents distributed worldwide. It is a major participant in setting standards for the national especially the infant & mom field in intelligent floor cleaning system. In the future, Diisea will continue to explore and develop more efficient technologies and products to solve the cleaning problems in various fields, strive to become a leader in the global intelligent cleaning field as China's original created technology!

#### 主要展品 /Products

滴水品牌推出行业首款母婴级洗地机——滴水大白洗地机, 搭载独创“水尘”环流技术, 实现低分贝、0 扬尘。无需高功率大电机, 58 超低分贝运行, 相比传统洗地机安静 4 倍以上, 比日常谈话声音还小, 不打扰孩子学习和家人休息; 同时, 滴水通过高速旋转水动力以拖代吸, 从源头上做到 0 扬尘、0 排放, 不给居家环境带来次生污染, 更适合带娃家庭使用。

The Dishui brand launched the industry's first maternal and infant grade floor cleaner, the Dishui Dabai floor cleaner, equipped with innovative "water dust" circulation technology to achieve low decibel and zero dust emission. No need for high-power motors, 58 ultra low decibels operation, more than 4 times quieter than traditional floor washers, and less noisy than daily conversation, without disturbing children's learning and family rest; At the same time, drip water is towed instead of sucked by high-speed rotating hydraulic power, achieving zero dust emission and zero emission from the source, without causing secondary pollution to the home environment, making it more suitable for families with children.

#### J&V

#### 湖北剑威电气科技有限公司 Hubei J&V Electric Technology Co., Ltd.

N4-4A33 4A34

地址: 中国湖北省宜昌市当阳市玉阳办事处和平村(金桥工业园) (444100)  
Add: Danyang Jinqiao Industry Park, Yichang City, Hubei Province, China  
电话 /Tel: 18666449099  
传真 /Fax: 0717-3159899  
网址 /Web: [www.jv-cn.com](http://www.jv-cn.com)

剑威科技 (英文简称 J&V) 由东莞市剑威电子科技有限公司、湖北剑威电气科技有限公司和美国剑威贸易公司组成, 成立于 2010 年, 是一家集室内高端家用电器、户外炉具、商用厨房核心配件产销于一体的高科技企业。

公司产品包括 PCB 主控系统、智能家居云系统、特种照明、非标连接线束、家居特种变压器、智能旋钮开关、燃气脉冲点火器、家电用传送马达、风机、发热式点火棒、温度传感器、红外传感器、整套电器系统方案定制等。

J&V Electronic Science and Technology Co., Ltd (hereinafter referred to as J&V) founded in 2010, consists of Dongguan J&V Electronic and Technology Co., Ltd, Hubei J&V Electric Technology Co., Ltd. and USA J&V Trading LLC., is a high-tech enterprise integrating production and marketing for indoors high-end household appliance, outdoor stoves, and the core accessories of commercial kitchens.

The company has long focused on the design, development and manufacturing of high-end home

appliances. The products include PCB main control systems, smart home cloud systems, special lighting, non-standard connections harness, special home transformers, smart knob switches, gas pulse igniters, and transmission motors for home appliances, fan, heating type ignition rod, temperature sensor, infrared sensor, complete electrical system program customization, etc. The products sell well in more than 100 countries and regions at home and abroad.

#### 主要展品 /Products

PCB 主控系统、智能家居云系统、特种照明、非标连接线束、家居特种变压器、智能旋钮开关、燃气脉冲点火器、家电用传送马达、风机、发热式点火棒、温度传感器、红外传感器、整套电器系统方案定制等

The products include PCB main control systems, smart home cloud systems, special lighting, non-standard connections harness, special home transformers, smart knob switches, gas pulse igniters, and transmission motors for home appliances, fan, heating type



#### 湖南航天磁电有限责任公司

#### HUNAN AEROSPACE MAGNET & MAGNETO CO.,LTD.

W3-3H92

地址：湖南省长沙市望城经济开发区腾飞路二段 1118 号 (410200)

Add: NO.1118, 2nd Section, tengfei Road, Wangcheng Economic Development Zone, Changsha, Hunan, China.

电话 /Tel: 86-731-88448268

传真 /Fax: 86-731-88448186

网址 /Web: www.spacemagnet.com

公司成立于 1995 年，隶属于中国航天科工集团，主要从事高性能磁性材料与元器件、智能传感器、机电产品及装备等的研发、生产、销售与服务。拥有长沙、常德两大产业园，共占地 500 余亩，员工总数 1100 余人，拥有 1 个航天科工集团级工程中心、3 个省级技术创新平台，现有效专利 190 余件并保持年增速 15% 以上，相关实验室已通过 CMA、CNAS 和 DILAC 资质认证。公司具有完善的质量、环境、职业健康安全管理体系。

Hunan Aerospace Magnet & Magneto Co., LTD. (hereinafter referred to as "HAMMC"), founded in 1995, belongs to Hunan Aerospace Co., LTD., a subsidiary of China Aerospace Science and Industry Corporation, mainly engaged in the research and development, production, sales and service of high-performance magnetic materials and components, intelligent sensors, mechanical and electrical products and equipment.

#### 主要展品 /Products

主营永磁铁氧体器件、电感元件、智能传感器。

The company's main permanent magnet ferrite devices, inductive components, intelligent sensors.



#### 正申科技

ZENNZE TECHNOLOGY

#### 湖南正申科技有限公司

#### HUNAN ZENNZE TECHNOLOGY LIMITED

W5-5B46

地址：长沙高新开发区麓枫路 61 号湘麓国际花园二期酒店、公寓 501

Add: Apartment 501, Xianglu International Garden II Hotel, No. 61 Lufeng Road, High-tech Development Zone, Changsha

电话 /Tel: 19918968668

网址 /Web: www.zennze.com

湖南正申科技有限公司成立于 2013 年 1 月，长期专注于超宽带 (UWB) 雷达技术的开发应用及产业化，是一家具有高度社会责任感的高新技术企业。本着“生命安全，科技守卫”的企业核心理想，公司将电子信息技术与智慧康养的行业需求紧密结合，自主研发了非接触式生命体征监测产品和系统为智慧养老、婴儿监护、智能酒店、智能家居、医疗监护、安防等领域应用提供核心传感模块和系统解决方案。

Hunan ZENNZE Technology Limited, founded in January 2013, is a very socially responsible high-tech enterprise dedicated to the development application and industrialization of the ultra-wideband (UWB) radar technology for a long period. In line with the core ideal, "life safety, Tech guard", we closely integrate electronic technology to the actual demands of the smart wellness industry and independently developed non-contact vital signs monitoring products and systems, providing core sensing modules and systematic solutions for smart eldercare for elderly, baby monitoring, smart hotel, smart home, medical monitoring, security and other fields.

#### 主要展品 /Products

DC100-4G/DC100-XR-WIF 无接触健康监护仪是一款基于超宽带 (UWB) 雷达技术和无线通信技术实现的非接触生命体征参数监测产品。通过发射和接收电磁波，在一定距离范里内扫描探测人体生命体征，能穿透衣服被凝等织物感应人体胸腔的起伏运动，运用相关的信号处理方法，实现人体呼吸和心率的监测功能以及睡眠质量评估应用。

DC100-4G/DC00-XR-WIF non-contact health monitor is a device for monitoring human life parameters without contacting the body. Based on the ultra-wideband (UWB) radar technology and wireless communication technology, the monitor can scan and detect the vital signs within limits by transmitting and receiving electromagnetic waves which can penetrate fabrics such as clothes and bedding to sense the undulating movements of the human chest. Using the relevant signal processing methods, the device can realize the monitoring functions of human respiration and heart rate and the application and assessment of sleep quality.

**湖州乐通电子科技有限公司****Huzhou Lotto Electronic Technology Limited****W4-4A55**

地址: 浙江省湖州市南浔区双林镇维多利亚大道3号(313012)

Add: 3 Victoria Avenue, Shuanglin Town, Nanxun District, Huzhou, Zhejiang province

电话 /Tel: 15905820369

传真 /Fax: 0572-3623988

网址 /Web: www.china-emicore.com

湖州乐通电子科技有限公司是集生产、科研、经营、信息服务为一体的科技型企业,主要生产抗干扰磁芯系列,非晶磁环系列,年产8000吨及过千种规格的产品。

Huzhou letong Electronic Technology Co., Ltd. is a technology-oriented enterprise integrating production, research, operation and information services. It mainly produces anti-interference magnetic core series and amorphous magnetic ring series, annual output of 8000 tons and more than 1000 kinds of specifications of products

**主要展品 /Products**

抗干扰磁芯系列包括铁氧体磁环、磁扣、磁棒等上千种规格,非晶磁环系列,

Anti-interference core series including ferrite magnetic ring, magnetic button, magnetic rod, etc. thousands of specifications, amorphous magnetic ring series,

**湖州南洋电机有限公司****HUZHOU NANYANG ELECTRIC-MOTOR CO., LTD****W3-3C62 3C63 3C64**

地址: 浙江省湖州市南浔经济开发区浔织路1888号(313009)

Add: NO.1888, XUNZHI ROAD, NANXUN, HUZHOU CITY, ZHEJIANG

电话 /Tel: 0572-3033671

传真 /Fax: 0572-3033838

网址 /Web: www.zjnanyang.com.cn

湖州南洋电机有限公司成立于1999年,是一家专业研发、生产、销售家用洗衣机电机为主,集制造、经贸于一体的现代化企业集团。旗下:南洋电机,天洋线缆,牧洋精密,科洋动能四大板块。主要客户:海尔,三星,美的,松下,夏普,海信,创维等,产品出口东南亚,欧美,中东,北非等十多个国家和地区。

**主要展品 /Products**

洗衣机电机, 干衣机电机, 新能源汽车电机部件等

**湖州越球电机有限公司****Huzhou Yueqiu Motor Co., Ltd.****N4-4A15 4A16**

地址: 浙江省湖州市南浔经济开发区南浔大道1888号

Add: 1888# Nanxun Avenue, Nanxun economic development zone, Huzhou City, Zhejiang, China.

电话 /Tel: 0572-3918316

网址 /Web: www.yqmotor.com

湖州越球电机有限公司创立于1999年,现生产基地坐落于浙江省湖州市南浔经济开发区,销售研发中心位于上海闵行区。越球是一家专注于研发、制造、销售电机和风机的高端制造企业,产品主要有家用洗衣机电机、家用空调电机、抽油烟机电机、汽车空调电机、洗碗机电机、面包机电机、干衣机电机及节能高效风机等,业务范围涵盖设计研发、客户解决方案、生产制造到产品服务的所有环节。

**主要展品 /Products**

家用洗衣机电机、家用空调电机、抽油烟机电机、汽车空调电机、洗碗机电机、面包机电机、干衣机电机及节能高效风机等



认真生活

**华帝股份有限公司****Vatti Corporation Limited****N2-2C01 2C11**

地址: 广东省中山市小榄镇工业大道南华园路1号(528400)

Add: No.1 Huayuan Road, Industrial South, Xiaolan, Zhongshan, Guangdong, P.R. China

电话 /Tel: 0760-22139888

传真 /Fax: 0760-22139888

网址 /Web: http://www.vatti.com.cn/

华帝股份有限公司自1992年创立至今,专注厨电领域,产品创新为企业战略重心,凭借优质的全球供应链、专业的研发团队、时尚智慧的产品,为全球多个国家和地区的消费者提供高品质的服务。以高端智能厨电为定位,致力于成为全球高端品质厨房空间的引领者。产品涵盖抽油烟机、燃气灶、热水器、洗碗机、蒸烤一体机、消毒柜、净水器、全屋定制等多个品类。在产品技术创新方面,华帝已获授权有效专利2300多项。

Since established in 1992, VATTI has been focusing on kitchen appliances for 29 years. Under reform bandwagon of kitchen appliances in the new era, VATTI always keep focusing on product innovation and building globalization path for Chinese national brands, growing from township enterprise based in the Pearl River Delta Economic Zone to the listed company steadily, and become one of top 500 value enterprises in China.

**主要展品 /Products**

抽油烟机、燃气灶具、燃气热水器、电热水器、壁挂炉、洗碗机、蒸烤一体机、蒸箱、烤箱、消毒柜、净水器,以及全屋定制等多个品类。

Range hood, Gasher, Water heater, Dishwasher, Steam Cooker, Roaster, Disinfection cabinet, Water purifier, Cupboard





**华为终端有限公司**  
**Huawei Device Co., Ltd.**

**W4-4F11**

地址: 广东省东莞市松山湖园区新城路2号(523808)

Add: No.2 Xincheng Road, Songshan Lake Campus, Dongguan City, Guangdong Province

电话 /Tel: 075528780808

传真 /Fax: 0755-36839731

网址 /Web: <https://consumer.huawei.com/cn/>

消费者业务是华为三大业务之一,作为全场景智慧生活领导者,其产品全面覆盖手机、个人电脑和平板电脑、可穿戴设备、移动宽带终端、家庭终端和消费者云等。基于华为三十多年通讯行业的深厚沉淀,凭借自身的全球化网络优势、全球化运营能力和全球化合作伙伴,华为消费者业务致力于将最新的科技带给消费者,让世界各地更多的人享受到技术进步的喜悦,以行践言,实现梦想。

As one of Huawei's three business groups, Huawei Consumer BG is the leader of the all-scenario AI life. It covers smartphones, PC and tablets, wearables, mobile broadband devices, family devices and device cloud services. Huawei Consumer BG is dedicated to delivering the latest technologies to consumers and sharing the happiness of technological advances with more people around the world. Walk the walk and make dreams come true.

**主要展品 /Products**

智能手机、智慧屏、全屋智能、音箱、路由、平板电脑、PC、VR设备、可穿戴设备等

Smartphone, Vision, Smart home, Speaker, Router, Tablet, PC, VR device, Wearable and ect.



**华祥检测机构**  
**华祥检测机构**

**Ningbo HATEK Co., Ltd**

**W5-5A32**

地址: 宁波市高新区木槿路65号6楼

电话 /Tel: 0574-87171888

网址 /Web: [www.hatek.com.cn](http://www.hatek.com.cn)

华祥是专业从事电气安全 Safety、电磁兼容 EMC、化学检测 Toy Physical&Chemical 检测、认证等领域的机构,依照实验室认可体系规范 ISO/IEC 17025 来严格执行品质管制,获得了 CNAS、CMA、TUV-Rheinland、FCC、UL、CPSC、ITS、IC、CSA、Hermes 等机构认可。华祥为您的产品获得各国认证提供全方位的服务,助您的产品畅销全球。

**主要展品 /Products**

1. 欧洲认证: CE,GS,ROHS,REACH,EN71,TUV,ErP, PAHS,PHTH 等
2. 美洲认证: UL,ETL,Pb65,CSA,IC,FCC,FDA 等
3. 亚洲认证: PSE,KC,CQC,CCC 等
4. 澳洲认证: SAA,C-Tick,RCM 等
5. 非洲认证: SONCAP,SABS
6. 国际认证: CB 认证,IEC 测试报告
7. 中东地区: COC,VOC,SABER 等
8. WiFi 认证
1. 欧洲认证: CE,GS,ROHS,REACH,EN71,TUV,ErP, PAHS,PHTH 等

2. 美洲认证: UL,ETL,Pb65,CSA,IC,FCC,FDA 等
3. 亚洲认证: PSE,KC,CQC,CCC 等
4. 澳洲认证: SAA,C-Tick,RCM 等
5. 非洲认证: SONCAP,SABS
6. 国际认证: CB 认证,IEC 测试报告
7. 中东地区: COC,VOC,SABER 等
8. WiFi 认证



**环驰轴承集团有限公司**  
**Huanchi Bearing Group Co., Ltd**

**W4-4B01**

地址: 浙江省慈溪市横河镇马堰工业区(315318)

Add: Henghe Industry Zone,Cixi City,Zhejiang315318,P.R.China

电话 /Tel: 0574-63199858

传真 /Fax: 0574-63199595

网址 /Web: [www.hch.cn](http://www.hch.cn)

专业从事精密轴承的研发生产和销售30多年,拥有三大制造基地和一个研发中心,2300多名员工,日产轴承200万套,年销售额23.90亿元,是中国规模最大的球轴承生产企业之一。

产品广泛应用于汽车及零部件、机器人、电机、减速机、齿轮箱、家用电器、电动工具、园林工具、农用机械和泵类等领域,是诸多世界五百强企业的长期配套供应商,主要客户有德国博世、西门子、日本电产、松下、韩国三星、LG等。

**主要展品 /Products**

专业生产微型、小型、中大型精密深沟球轴承,圆锥滚子轴承。



**黄山市华特电器有限公司**  
**Huangshan Watts Electrical Co.,Ltd**

**E3-3B47**

地址: 安徽省黄山市祁门县灯塔谢家山(245600)

Add: Dengta country ,Qimen county ,Huangshan city ,Anhui province ,China.

电话 /Tel: 0559-4503902

传真 /Fax: 0559-4503869

网址 /Web: [www.wattshw.com](http://www.wattshw.com)

黄山市华特电器有限公司位于中国黄山市,是一家专业研发、生产、销售美容美发家用电器的国家高新技术企业,占地面积10100 m<sup>2</sup>。现有员工108人,拥有高级工程师,熟练技师,国际贸易等一批优秀人才。

目前主要产品有电吹风、卷发筒、烫发夹三大系列一百多款产品。产品通过CE/GS/ROHS/ETL认证,公司具有十几年的美发产品国际贸易经验。

Huangshan Watts Electrical Co., Ltd. ,established in 2004,is one of the professional manufacturers and exporters of personal hair care products.The hair dryers, hair straighteners, hair curling iron produced by our company are all designed by ourselves and patented products. They sell well

on markets of more than 30 countries and regions, such as Japan, Germany, France, UK, Italy, Spain, Brazil, Chile, and US. The group takes the lead in passing ISO9001 in the same trade: domestic sale products take the lead in passing CCC authentication the same trade, international products all pass authentication such as CE, GS, EMC, ETL, etc. With history, experience and practice, Huangshan Watts Electrical Co., Ltd. will always develop more steadily and persistently. It will serve as hearty as before.

#### 主要展品 /Products

吹风机, 卷发棒, 直发器  
hair dryers, hair straighteners, hair curling iron



#### 黄石东贝压缩机有限公司

#### Huangshi Donper Compressor Co., Ltd

W2-2D81

地址: 湖北黄石经济技术开发区·铁山区金山大道东6号(435000)

Add: Huangshi City, Hubei Province

电话 /Tel: 07146273829

传真 /Fax: 07145420558

网址 /Web: www.donper.com

黄石东贝压缩机有限公司是一家专业研发、生产、销售制冷压缩机的高新技术企业,是东贝集团A股上市的子公司。

公司长期致力于低碳、高效、节能、环保制冷压缩机的研究,在中国黄石、巴西若因维利分别建有研发中心。公司先后从德国、瑞士、日本、意大利引进了国际先进水平的生产设备和生产线,能生产12大系列200余个品种压缩机,具有型号多、规格全、冷量范围宽、功率跨度大的特点,年生产能力达4500万台。

Huangshi Donper Compressor Co., Ltd is an A-share Listed Company, a high-tech enterprise specializing in R&D, production and sales of refrigeration compressors.

The company has been committed to the research of low-carbon, high-efficiency, energy-saving and environmental protection refrigeration compressor for a long time. We have established R & D centers in Huangshi, China, and Joinville, Brazil, respectively. The company has successively imported international advanced production equipments and production lines from Germany, Switzerland, Japan and Italy, which can produce more than 200 varieties of 12 series compressors. It has the characteristics of many models, complete specifications, wide cooling capacity range and large power span, with an annual production capacity of 45 million units.

#### 主要展品 /Products

产品系列: 变频系列 (VFA)

工质: R600a

主要特点: 迷你型, 高效率、低噪音, 高可靠性、启动运行平稳、适应电源电压范围宽, 可无级变速等特点。

应用范围: 冰箱、冷柜、酒柜等。

Series: Variable Speed Compressor (VFA)

Refrigerant: R600a

Feature: Mini-type, high efficiency, low noise, high reliability, stable start and operation, wide voltage operation, infinitely variable speeds, etc.

Application: refrigerator, freezer, wine cellar, etc.



#### 惠而浦 (中国) 股份有限公司

#### Whirlpool (China) Co., Ltd

N4-4C51

地址: 安徽省合肥市高新技术开发区习友路4477号(231282)

Add: No.4477 Xiyu Road, New&Hi-Tech Industrial Development Zone, Hefei, Anhui

电话 /Tel: 4008899360

传真 /Fax: 055165338027

网址 /Web: www.whirlpool.com.cn

国际品牌惠而浦创立于1911年,以创新的功能、精湛的工艺在各个时代带动全球家电行业进化与突破。惠而浦(中国)股份有限公司(股票代码:600983)于2014年成立,总部位于安徽省合肥高新技术产业开发区。目前,惠而浦(中国)旗下拥有惠而浦、帝度品牌,涵盖冰箱、洗衣机、洗碗机、干衣机以及厨房电器、生活电器等产品线,致力于成为最好的洗衣和厨房解决方案供应商。

Since its founding in 1911, the international brand Whirlpool has been developing innovative functions & exquisite craftsmanship of products. And with these, it has driven the evolution and breakthrough of the global home appliance industry for years. Whirlpool (China) Co., Ltd. (stock code: 600983) was established in 2014, and it is headquartered in Hefei High-tech Industrial Development Zone, Anhui Province. To become the best laundry and kitchen solution provider is its vision. At present, it has two brands, Whirlpool and Diqua. And the products cover refrigerators, washing machines, dishwashers, dryers, kitchen appliances, etc.

#### 主要展品 /Products

冰箱、洗衣机、洗碗机、干衣机及厨房电器、生活电器等



#### 惠州三华工业有限公司

#### HUIZHOU SANHUA INDUSTRIAL CO.,LTD

W1-1B56

地址: 广东省惠州市仲恺高新技术开发区14号小区

电话 /Tel: 0752-2771183

网址 /Web: www.cnsanhua.com

惠州三华工业有限公司成立于1998年7月,是一家集研发,制造及销售为一体的全球专业电源部品及电源系统供应商。产品涵盖智能家电电源、OA办公设备电源、新能源及工业类定制电源三大类别。广泛应用智能家电、OA办公设备、新能源汽车等众多行业。

公司在海内外设有4个研发中心,分别在深圳、惠州、青岛、日本。并被认定为广东省工程技术研究中心、广东省企业技术中心、广东省创新型企业、国家知识产权优势企业等。

#### 主要展品 /Products

智能家电电源系列、OA办公设备电源系列、工业及新能源定制电源系列、智能小家电电源系列等



**惠州市富进贸易有限公司**  
**Warran**

**N3-3A35 3A36**

地址: 深圳市南山区侨香路 4088 号绿景美景广场 C 座 5 楼 522 室  
Add: Room 522, 5th Floor, Block C, Lvjing Meijing Square, 4088 Qiaoxiang Road, Nanshan District, Shenzhen  
电话 /Tel: 15012802472  
传真 /Fax: 55666856  
网址 /Web: www.warran.com.cn

Warran- 品牌理念 - 创造厨房新的生活方式  
小家电是当下中国家庭结构的大趋势  
现在的新时代无论是居住环境, 生活方式都和以前大不相同  
我们 Warran 致力为我们的新时代, 创造厨房新的生活方式

Deep Warren - brand concept - create a new lifestyle in the kitchen  
Small household appliances are the general trend of China's family structure  
In the new era, the living environment and lifestyle are very different from those in the past  
We Warren are committed to creating a new kitchen lifestyle for our new era

**主要展品 /Products**

厨房小家电  
Deep w kitchen appliances



**HONGYU**

**惠州市宏宇高科电子有限公司**  
**HUIZHOU CITY HONGYU HIGH-TECH ELECTRONICS CO.,LTD**

**N4-4B01**

地址: 广东省惠州市博罗县石湾镇建设中路 109 号 (516127)  
Add: No.109, Jianshe Mid Road, Shiwan Town, Boluo County, Huizhou City, Guangdong Province, China.  
电话 /Tel: 0752-6116051  
传真 /Fax: 0752-6116050  
网址 /Web: www.hongh.com

惠州市宏宇高科电子有限公司成立于 2009 年, 是一家专业生产电位器、开关、编码器、传感器、开关模组一站式方案解决商。公司已通过 SGS ISO9001:2015、ISO14001:2015、VDE、UL、REACH、POPS、3C 等认证。秉承“客户导向, 精益求精, 全员参与, 尽善尽美”之品质政策, 全面建立质量管理体系, 满足客户需求, 提升服务质量, 为客户提供更优质的产品与服务。

Huizhou HongYu High-Tech Electronics Co., Ltd. was established in 2009, is a one-stop solution provider specializing in the production of potentiometers, switches, encoders, sensors and switch modules. Our products are widely apply to household appliances, automobiles, aviation, medical, toys, mixers, dimmers, musical instruments, and computer peripheral products etc. HongYu has passed ISO9001:2015, ISO14001:2015, VDE, UL, REACH, POPS, 3C etc. certifications. Adhering

to the quality policy of "customer orientation, excellence, full participation, perfection", We have established a quality management system to meet customer needs, improve service quality, and provide customers with better products and services.

**主要展品 /Products**

电位器、开关、编码器、传感器、旋钮、模组  
potentiometer, switch, encoder, sensor, knob, mould



**火星人厨具股份有限公司**  
**Marsenger Kitchenware Co., Ltd.**

**N2-2F61**

地址: 浙江省海宁市尖山新区新城路 366 号 (314415)  
Add: No. 366, Xincheng Road, Jianshan New District, Haining City, Zhejiang Province  
电话 /Tel: 0573-87610000  
传真 /Fax: 0573-87019290  
网址 /Web: www.marsenger.com

火星人厨具股份有限公司是以集成灶为主, 拥有集成洗碗机、集成水槽、水槽洗碗机, 橱柜等产品, 进行研发、生产和销售的企业。

拥有 342 亩智慧工业园, 1500 m<sup>2</sup> 工匠实验室, 累计获得 290 余项专利。参与制定《集成灶》国家及行业 3 项标准, 荣获高新技术企业认证、浙江制造“品”字标、中国外观专利优秀奖等多项政府权威认证。20 年度不含税营业额超 16 亿, 21 年前三季度营收 15.98 亿, 成为集成灶行业营收第一的企业。

Marsenger was founded in 2010. After 11 years' development, it has become a manufactory with integrated stoves as main products, and meanwhile, produces integrated dishwashers, integrated sinks, in-sink dishwashers and cabinets. All Marsenger's R&D, production and sales activities are aimed at making cooking healthier.

Marsenger owns 228,000 m<sup>2</sup> smart industrial park, 1,500 m<sup>2</sup> of laboratory, and has obtained more than 290 patents in total. With excellent technology, it participated in the constitution of 3 standards for Integrated Stove Industry at national level. Marsenger won many government authorized certifications such as high-tech enterprise technology certification, Zhejiang manufacturing "Pin"-Word (Means quality products) Mark, and Excellent China Appearance Patents.

In 2020, the tax-free turnover exceeded 2,540 million Dollars. In 2021, the income of the 3 quarters was 2535 billion, making it the No.1 company among the integrated stove manufactories.

**主要展品 /Products**

火星人 Q6BC 集成灶  
火星人 Q35C 集成灶  
火星人 E7BC 集成灶  
火星人 X7C 集成灶  
火星人 X5C 集成灶  
火星人 X8Z 集成灶  
火星人 T7C 集成灶  
火星人 E30BC 集成灶  
火星人 T30BC 集成灶

火星 D70 集成洗碗机  
火星 D7 集成洗碗机  
火星 U1 集成水槽洗碗机  
火星 U6 集成水槽洗碗机

Marssenger Q6BC integrated stove  
Marssenger Q35C integrated stove  
Marssenger E7BC integrated stove  
Marssenger X7C integrated stove  
Marssenger X5C integrated stove  
Marssenger X8Z integrated stove  
Marssenger T7C integrated stove  
Marssenger E30BC integrated stove  
Marssenger D70 integrated dishwasher  
Marssenger D7 integrated dishwasher  
Marssenger U1 in-sink dishwasher  
Marssenger U6 in-sink dishwasher

**极电光能**  
Utmolight

**极电光能有限公司**

**W4-4B11**

地址: 无锡市锡山经济技术开发区通云南路 77 号 (214106)

电话 /Tel: 0510-81922005

传真 /Fax: 0510-81922005

网址 /Web: www.utmolight.com

极电光能有限公司是全球领先的钙钛矿产业化技术开发企业, 专注于钙钛矿光伏、光电及前驱体材料的产业化技术开发和应用。极电光能是国家工信部认定的“智能光伏试点示范企业”。2022 年入选无锡市独角兽企业、江苏省潜在独角兽企业、GEI 中国潜在独角兽企业。

作为绿色能源产业的新锐力量, 极电光能始终坚持以技术创新引领钙钛矿产业发展。目前极电光能在钙钛矿技术研发和产业化方面均处于行业领先地位。

**主要展品 /Products**

量子点是指尺寸在纳米量级的半导体晶体结构, 由于激子被量子限域, 能带结构分立, 受激后可以发射荧光或产生电流。与传统量子点相比, 钙钛矿量子点具有量子产率高, 半峰宽窄, 工艺简单, 成本低廉等优势。同时, 钙钛矿量子点的无镉特性可满足欧盟 RoHS 环保标准, 是新型量子点显示技术的有力竞争者。极电光能致力于钙钛矿量子点的产业化应用开发, 不断创新, 已申请专利 50 余项, 并且正与多家下游厂商共同开展产品开发和性能评测。

**jiaxipera**

**加西贝拉**

**加西贝拉压缩机有限公司**  
**JIAXIPERA COMPRESSOR CO.,LTD.**

**W2-2F81**

地址: 浙江省嘉兴市南湖区亚中路 588 号 (314006)

Add: NO.588,Yazhong Road,Nanhu Region,Jiaxing,Zhejiang,China

电话 /Tel: 057382586166

传真 /Fax: 057382586181

网址 /Web: www.jiaxipera.com.cn

加西贝拉压缩机有限公司成立于 1988 年 12 月 28 日, 位于党的诞生地 --- 浙江嘉兴南湖之畔, 是全球环保、节能、高效冰箱压缩机的专业研发制造企业, 中国家电协会副理事长单位, 浙江省家电协会理事长单位, 冰箱压缩机国家标准修订组长单位, 国家技术创新示范企业。

Jiaxipera Comperssor Limited Company, which was founded on December 28, 1988, is located on the Bank of Nanhu, Jiaxing, Zhejiang Province, the birthplace of the Communist Party of China. Jiaxipera is a global and professional developer and manufacturer of eco-friendly, energy saving and high efficiency compressor for refrigerator and freezer. It is the vice president unit of China Household Electrical Appliance Association and Zhejiang Household Electrical Appliance Association, Unit leader of National Standard revision of refrigerator compressor and National Demonstration Enterprise of Technology Innovation.

**主要展品 /Products**

VN 变频、VT 变频、VM 变频、T 定频、N 定频、M

VN variable speed compressor, VT variable speed compressor, VM variable speed compressor, T on-off Series, N on-off Series, M series



**家里泉健康科技(苏州)有限公司**

**Jialiquan Health Technology (Suzhou) Company Limited**

**E2-2E61**

地址: 苏州工业园区科营路 2 号中新生态大厦 511 室

电话 /Tel: 15210162993

家里泉是专业的矿泉机品牌, 核心技术团队 14 年来深耕高端水处理技术领域, 创新研究了智能电控技术、即热技术, 以及联合中国地质大学(北京)研究甄选 3500 处优质矿源, 取材考究“健康与天然”, 创新性地将矿石矿化技术、过滤技术融入到每一款矿泉机上, 还原天然矿泉水水路, 为家庭健康饮水提供更安全的、高品质的、智能便捷的饮水方案。家里泉, 家里一键出矿泉, 通过中美日欧多国标准, 泡茶更甜做饭更香。

**主要展品 /Products**

家里泉矿泉机:

家里泉矿泉机长效系列

家里泉矿泉机养生系列

家里泉矿泉机厨艺系列

家里泉矿泉机 MINI 系列





### 嘉丰工业科技(惠州)有限公司

E1-1C76

地址: 惠州市惠阳区大亚湾西区龙海三路9号嘉瑞科技园(516200)

电话 /Tel: 0752-3098666

传真 /Fax: 0752-3098699

网址 /Web: www.kashui.com

嘉丰工业科技(惠州)有限公司隶属于嘉瑞集团。嘉瑞集团于1980年在香港创立,是领先产品方案企业,尤其以镁、铝、锌合金压铸,注塑业,小家电业务为主。我们于惠州、深圳、苏州和芜湖设立多个生产基地,并于美国设立销售分公司。本集团总占地面积超过320,000平方米,员工超过4,000人,并于香港联合交易所主板上市(股份代号:822)。

Ka Shui Group, founded in Hong Kong in 1980, is a leading enterprise on product solutions, notably in magnesium, aluminum and zinc alloy die casting and plastic injection moulding and small household electrical appliance. We have set up a number of production bases in Huizhou, Shenzhen, Suzhou and Wuhu in China, and a sales branch in the United States. The Group has a total manufacturing area of over 320,000 square meters and over 4,000 employees. Ka Shui Group is listed on the Main Board of The Hong Kong Stock Exchange of Hong Kong Limited (Stock Code: 822).

#### 主要展品 /Products

吸尘器, 扫地机, 扫地机器人, 干手器

Vacuum cleaner, sweeper, robot, hand dryer



### 嘉兴海格电器有限公司

N1-1D76

地址: 嘉兴市南湖区大桥镇嘉兴工业园区

电话 /Tel: 18067082837

嘉兴海格电器有限公司, 成立于2012年3月, 是一家专注于健康与智能水家电专业制造商。公司座落在嘉兴市工业园区, 拥有专业的研发与生产制造团队; 公司一直致力于中央前置净水系列产品的研发、设计、生产与销售。公司专注于前置过滤器的OEM/ODM 6年, 服务众多国内净水品牌、卫浴品牌、管道品牌等行业, 公司期待能在接下来的时间同您合作、共创精彩。

#### 主要展品 /Products

中央前置过滤器, 阻垢软水器



### 嘉兴劲峰智能科技有限公司

W4-4H71

#### Jia Xing King-Top Intelligent Tech . Ltd

地址: 浙江省嘉兴市南湖区由拳路4818号5幢706室

电话 /Tel: 1358499179

智能显示方案系统设计服务

物联网平台, 为车辆实现“位置查寻、智能数据监控、行程管理、及时响应、预警机制、升级全链路数据分析”的多种解决方案

#### 主要展品 /Products

二轮车仪表, 家电显示屏



### 鉴衡巍德谊(浙江)检测认证有限公司

W5-5B06

#### VDE CGC (Zhejiang) Testing and Certification Co., Ltd.

地址: 广东省中山市三角镇金三大道东8号民森信息科技产业园C区一层之二和五层之二(528445)

电话 /Tel: 020-32204370

传真 /Fax: 02083752576

网址 /Web: www.vdecgc.com

鉴衡巍德谊已获得CNAS实验室认可及CMA资质认定证书, 是国家认监委指定的强制性产品认证实验室(家用和类似用途设备、照明电器、信息技术设备以及小功率电动机), 也是德国VDE在中国的授权CB实验室, 具备按相应认可准则开展检测服务的技术能力。实验室测试能力涵盖EMC测试、环境可靠性测试、安全测试等, 可为家用电器、照明电器、音视频与信息技术设备、压缩机和电机、电器附件等行业, 提供全球多国检测认证服务。

VDECGC has obtained CNAS laboratory accreditation and CMA certificate, and has the technical ability to carry out testing services in accordance with corresponding accreditation criteria.

The company's laboratory testing capabilities include EMC testing, environmental reliability testing, safety testing, performance testing, energy efficiency testing, materials testing etc. It can provide many countries around the world certification services for product industries such as household appliances, lighting products, IT/AV Products, compressors and motors and electrical components, and truly achieve "one test, multiple certificates", helping Chinese companies to expand the domestic market more efficiently and enter the international market more quickly.

#### 主要展品 /Products

面对复杂且多样的市场法规, 产品的研发及销售计划可能会因此受到阻碍。凭借VDE和CGC拥有广泛的全球认可, VDECGC的专家根据各类国际和当地标准, 提供多种国际认证服务, 包括中国CCC强制性产品认证、德国VDE认证、VDEGS认证、全球互认CB认证、加拿大CSA认证等, 使产品更快速、更顺利地销往目标市场。

Faced with complex and diverse market regulations, product development and sales planning may be hindered. With VDE and CGC's extensive global recognition, VDECGC's experts provide a variety of international certification services based on various international and local standards, including China, Germany, South Korea, Russia, Saudi Arabia and other regions, make products sell faster and smoother to target markets.

## ARROW

箭牌家居

箭牌家居集团股份有限公司

Arrow Home Group Co., Ltd

N1-1F61

地址: 佛山市禅城区南庄镇科洋路 20 号箭牌大厦

Add: Arrow Mansion, No.20 Keyang Rd., Nanzhuang, Chancheng Dist., Foshan, Guangdong, China

电话 /Tel: 0757-66851005

传真 /Fax: 0757-66851005

网址 /Web: <https://www.arrow-home.cn/>

箭牌家居集团秉承“持续改善人们的智慧家居生活品质”的企业使命, 坚持科技创新的理念, 不断开发满足和超越客户需求的产品和服务; 追求客户极致体验, 保持质量、服务、成本、性能、环保等方面的持续领先; 通过实施全球化、智能化、物联化打造智慧家居集团, 运用多品牌多品类协同, 打造智慧家居全产业链; 为客户提供高品质的智慧家居整体解决方案, 向“成为国际一流的智慧家居整体解决方案提供商”的愿景迈进。

ARROW sticks to its mission, continues to improve people's smart home life, adheres to technological innovation, and constantly upgrades the service and products that meet customer's need.

We pursue the best customer experience, and take the lead in product quality, service, cost, performance and environmental protection.

We try to build a smart home group characterized by globalization, intelligence and internet of things, and to create a whole industrial chain of smart home by multi-brand and multi-category collaboration.

We strive to provide customers with high-quality smart home solution and to become a world-class supplier of the overall smart home solutions

### 主要展品 /Products

主要产品涵盖智能卫浴、陶瓷洁具、龙头五金、浴室家具、浴缸浴房、瓷砖、定制橱柜、衣柜等品类  
ARROW's main products include intelligent sanitary ware, ceramic sanitary ware, faucets, hardware accessories, bathroom furniture, bathtubs, shower rooms, ceramic tiles, customized cabinets and wardrobes.



江门吕泉记五金制品厂

LUI CHUEN KEE (JIANGMEN) METAL MANUFACTORY

W1-1B10

地址: 广东省江门市蓬江区杜阮镇杜阮南路 39 号 (529163)

Add: No.39 South DuRuan Road, QiLongShan Ind. Area, DuRuan Town, JiangMen City, GuangDong Province, China

电话 /Tel: 0750-3661889

传真 /Fax: 0750-3662211

网址 /Web: [luichuenkee.com](http://luichuenkee.com)

吕泉记五金制品厂二十世纪六十年成立于香港, 是一家专业从事厨房设备及其配件开发设计和制造的大型企业。在开发生产的同时, 企业积累了宝贵的技术经验, 已具备了完善的五金冲压、深拉伸、

特殊拉伸、铸造及加工工艺, 进一步开发高技术质量的产品, 潜力无限。随时欢迎阁下光临本厂, 我们将为您提供高质量的产品, 高质量的服务!

### 主要展品 /Products

不锈钢水盆, 不锈钢洗手盆, 厨房设备不锈钢配件, 炉具配件, 不锈钢油缸



江门美兹智能科技有限公司

Jiangmen Mielux Intelligent and Technology Co., Ltd.

N3-3B46

地址: 广东省江门市蓬江区棠下镇桐乐路 13 号

Add: Tongle Road #13, Tangxia Town, Pengjiang District, Jiangmen, Guangdong, China

电话 /Tel: 0750-3937902

网址 /Web: <https://mielux.en.alibaba.com/>

江门美兹智能科技有限公司专业从事家用电器的研究、开发和制造。成立于 2012 年, 专业生产面包机, 意式咖啡机, 咖啡磨豆机等。

产品通过 GS/CE/CB/ROHS/LFGB/FDA 认证, 与及满足不同的国际标准。

工厂面积 15000 平方米, 拥有 300 多名熟练工人, 每月可保证至少 10 万套。我们的研发团队——15 名拥有 10 年以上电器经验的工程师, 可以与您密切合作, 开发新产品。

欢迎与我们合作, 共创双赢。

### 主要展品 /Products

我们的主要产品有 EM3601、EM3202、EM3101 等多款家用意式浓缩咖啡机。

意式咖啡机, 是咖啡机的一种。其原理是采用高压蒸汽和水的混合物快速穿过咖啡层, 瞬间萃取出咖啡。这样出来的咖啡温度很高, 咖啡因等杂质的含量很低, 并且口感浓郁。

我们的产品能制作出高品质意大利咖啡; 功能全面, 可以做很多花式咖啡。



## 竞晖家电

江门市竞晖电器实业有限公司

JIANGMEN KINGFAI ELECTRICAL APPLIANCE IND.CO., LTD

N3-3A20

地址: 中国广东省江门市蓬江区杜阮镇双楼村嘉宝路 23 号竞晖电器产业园 (529000)

电话 /Tel: 86-0750-3283855

传真 /Fax: 86-0750-3283323

网址 /Web: [www.kingfai.com.cn](http://www.kingfai.com.cn)

盈美电器是江门市竞晖电器实业有限公司下属品牌, 于 2017 年荣获广东省驰名商标。公司位于广东江门, 一家生产揉面机、搅拌机、碎肉机等集产品设计生产及销售一体化的产品出口外销型企业。拥有现代化办公设备和大型厂房、花园式厂区, 有完善配套的生产设施和训练有素的生产人员, 并拥有先进的生产流水线、雄厚的产品研发力量, 严格的质量控制系统、高效精密的检测仪器, 为企业的高速发展打好了基础。

### 主要展品 /Products

厨师机、打蛋机、多功能料理机、碎肉机等

## SOJO TECH®

江门市双杰电机有限公司

W2-2B44

JiangMen SOJOTECH Motor Co., LTD.

地址: 广东省江门市鹤山凤亭路 863 号 3 楼 (529700)

Add: 3rd Floor, No. 863, Fengting Road, Heshan City, Jiangmen, Guangdong Province

电话 /Tel: 15018002777

传真 /Fax: 15018002777

网址 /Web: https://sojomotor.1688.com

双杰合精工电机总部位于珠三角西南部江门鹤山市。公司于 2015 年由两位资深电机工程师创立, 公司主要是对直流无刷电机、减速电机、风机、水泵等材料特性、结构探索、研发; 所生产出的精工产品广泛应用于二类医疗许可背心式排痰机、生物颗粒取暖炉、呼吸机、垃圾烘干机、果蔬净食机、化学分析仪器、家用取暖器、电子烟花机等一系列工业与民用节能环保产品上。

双杰合公司发展理念: "专业是基础! 服务是保证! 质量是信誉!"

Sojo Tech. Motor is headquartered in Heshan City, Jiangmen, Guangdong province. The company was founded in 2015 by two senior electrical engineers. The company mainly researches and develops the characteristics and structure of brushless DC motors, gear motors, fans, and water pumps. Products are widely used in series of industrial and civil energy-saving and environmentally friendly products, such as the second-class medical license vest type expectoration machine, biological pellet heater, ventilator, garbage dryer, fruit and vegetable purifier, chemical analysis instrument, household heater, electronic firework machine and so on. The company relies on superb technology, advanced manufacturing and testing equipment, as well as modern management and technical personnel and excellent staff to develop into a customer-trusted enterprise.

The development philosophy of Sojo Tech. Company: "Professionalism is the foundation! Service is the guarantee! Quality is the prestige!"

## 主要展品 /Products

直流无刷电机、减速电机、直流无刷贯流风机、高速风机、贯流风机

Brushless DC motor, geared motor, brushless DC cross flow fan, high speed fan, cross flow fan

## SEEDEN

江门市西子电器科技有限公司

E1-1H86

SEEDEN

地址: 江门市江海区金瓯路 288 号 2 幢 9 楼 904 室 (529000)

Add: Jiangmen Sidis Electric Appliance Technology Co., Ltd Address: Room 904, 9/F, Torch Building No. 288 Jin Ou Road, Jiang Hai Distric, Jiangmen City, Guangdong Province, China.

电话 /Tel: 0750-3788653

传真 /Fax: 0750-3788653

网址 /Web: https://www.sidiss.cn/

公司始建于 2014 年 12 月 03 日, 占地面积 20000 m<sup>2</sup>。国家级高新技术企业, 广东省工程技术研究中心。公司从事智能、节能、环保、高档生活家电的研发、生产和销售。现已形成空气循环扇四个系列, 加湿器, 电暖器等百余款产品。公司通过了 ISO9001 质量体系认证; Sedex, BSCI 等国际认, 全部产品

已通过国内 3C 产品强制认证; 以及 CB、CE、ROSH、ETL 等国际认证。公司拥有各项专利五十余份。

Jiangmen Seeden Appliance Technology Co., Ltd. was established on 3th Dec, 2014, covering an area of 20,000 square meters. It is specialized in the research, development, production and sales of intelligent, energy saving, environmental protection and high-grade household appliances, and we have formed a series of DC variable frequency fans: DC stand fans, DC circulator fans, DC mist fans, charging energy-saving fans, humidifiers, electric heaters. Currently in China, we have most DC series products, and we have most varieties of fans, our products mainly export to South Korea (PASECO, EMK, HAAN, IRIVER, JAJU), Taiwan (Chi mei, Dong yuan, Heran), Japan (Don Quixote, YUASA, Morita), China (Midea, little bear, universal tesco, Haier, Westinghouse), the United States (wal-mart), Europe (Kingfisher, Meaco, Thomson, Schneider), the Malaysia (KHIND), and other customers.

## 主要展品 /Products

现已形成空气循环扇四个系列, 加湿器, 电暖器等百余款产品, 公司通过了 ISO9001 质量体系认证; Sedex, BSCI 等国际认, 全部产品已通过国内 3C 产品强制认证; 以及 CB、CE、ROSH、ETL 等国际认证。公司拥有各项专利五十余份。

DC stand fans, DC circulator fans, DC mist fans, charging energy-saving fans, humidifiers, electric heaters.



江苏艾科赛特新材料有限公司

N4-4B21

Jiangsu Aquaset New Materials Co., Ltd.

地址: 南京市栖霞区新港开发区恒园路龙港科技园 B2 栋 12 楼 (210038)

Add: 12F B2 Building of TSP, Hengyuan Road, Nanjing Development Zone, NJ, JS

电话 /Tel: 02585612626

传真 /Fax: 02585612929

网址 /Web: www.aquaset.cn

江苏艾科赛特新材料有限公司是一家集研发、生产和销售一体的科技型企业, 专注于无甲醛、零 VOC、水溶性环保型的化学品粘剂及绿色环保体系应用方案。艾科赛特始终坚持“从产品的生产到失效过程中, 无甲醛释放且严格控制 VOC”的产品理念。艾科赛特自主研发的水性无甲醛粘剂以其优越和稳定的品质, 已在绝热材料、实木多层复合板材等领域被广泛应用, 并参与了多项国家标准编制, 拥有十多项发明专利。

Jiangsu Aquaset New Materials Co., Ltd. is a scientific and technological company which integrates R & D, production and sales, focusing on formaldehyde-free, zero VOC, water-soluble and environmentally friendly chemical binders and green environmental protection system applications. Aquaset has always adhered to the product concept of "no formaldehyde release and strict control of VOC in the process of product production and invalidation", continuously increasing investment in scientific research, laying stress on the training of various talents, accumulating high-quality customer resources, and having an enormous potential market prospect. Because of its superior and stable quality, the waterborne formaldehyde-free binder developed by Aquaset has been widely used in various fields, such as insulation material, plywood and so on. Furthermore, Aquaset has participated in the compilation of a number of national standards and has obtained more than ten invention patents.

**主要展品 /Products**

无甲醛低 VOC 保温吸声环保玻璃棉  
无甲醛低 VOC 水性热固化粘剂  
水性无醛木工粘剂

Environmental fiberglass with formaldehyde-free, low VOC, thermal insulation and sound absorption

Formaldehyde-free low VOC waterborne heat curing binder  
Waterborne formaldehyde-free wood binder

**江苏安惠医疗器械有限公司****W1-1A53 1A54**

地址: 江苏省南通市经济技术开发区振兴路 95 号  
电话 /Tel: 051385989732

江苏安惠医疗器械有限公司成立于 2006 年, 是一家致力于健康医疗领域产品的研发、生产和销售科技型的企业。经过十多年的发展, 安惠医疗形成了家用按摩器和家用医疗护具两大产品系列。公司拥有国内外专利百余项, 先后获得 ISO9001、ISO13485 等质量管理体系认证, 完成美国 FDA 认证, 并通过了欧盟 CE, 澳大利亚 TGA、IEC 等产品安全认证。荣获南通市科学技术进步奖, 南通最佳设计企业奖等殊荣。

**主要展品 /Products**

颈部牵引器, 颈椎固定带, 腰部牵引器, 胸腰骶固定器, 颈部康健按摩器, 腰部康健按摩器, 膝部康健按摩器等

**BAILE****江苏百乐电器有限公司****W2-2B20 2B21 2B22 2B23****Jiangsu Baile Electric Co.,LTD**

地址: 江苏百乐电器有限公司 (212200)  
电话 /Tel: 0511-88431571  
传真 /Fax: 0551-88436699  
网址 /Web: WWW.CHINA-BAILE.COM

江苏百乐电器有限公司是一家专注与生产高端的多样的热熔断体制造商, 位于中国东南部, 濒临上海, 南京。自 1985 年来, 专心研制温度保险丝, 并自主研发多套自动化生产线应用于温度保险丝生产, 年产量 2 亿只。2012 年成功注册品牌“BAILE”, 并以科技创新为导向, 以顾客至上为经营理念。良好的售后服务, 赢得了广大客户的一致好评, 让百乐的品牌在同行业中遥遥领先。

Jiangsu Baile Electric Co., Ltd. is a manufacturer of high-end and diversified thermal fuses, located in the southeast of China, near Shanghai and Nanjing. Since 1985, concentrating on the development of temperature fuse, and independent research and development of several sets of automatic production lines applied to the production of temperature fuse, the annual output of 200 million. In 2012, we successfully registered the brand "BAILE", and take scientific and technological innovation as the guidance, customer first as the business philosophy. Good

after-sales service, won the praise of the majority of customers, let Baile brand in the industry far ahead.

**主要展品 /Products**

温度保险丝, 热保护器, 温控器, 内部连接线。  
thermal fuse, thermal protector, thermostat, inner connecting wire.

**江苏常胜电器股份有限公司****N4-4B47****Jiangsu Changsheng Electric Appliance Co.,Ltd**

地址: 江苏省常州市新北区天山路 38 号 (213032)  
Add: No.38, Tianshan Road, New-north district, Changzhou, Jiangsu, PRC  
电话 /Tel: 0519-85920008  
传真 /Fax: 0519-85920008  
网址 /Web: www.china-desheng.com

江苏常胜电器股份有限公司坐落在常州市高新技术开发区, 占地面积 40000 余平方米, 建筑面积 35000 平方米, 公司在常州、淮安、芜湖、佛山有六个分公司。拥有固定资产达 2 亿元, 员工 1800 余人, 其中专业技术和管理人员 200 余人。公司拥有日本引进的专业自动化生产设备 50 多套检测仪器 20 多套及国产生产检测设备 400 多套, 主要生产保护器、电机测速传感器、温度熔断器、UL 电子线、电源线总线、电机绝缘纸等产品。

Jiangsu Changsheng Electric Appliance Co., Ltd. is located in Changzhou High-tech Development Zone. It has a floor area of more than 40,000 square meters, a building area of 35,000 square meters, six branch companies in Changzhou, Huai'an, Wuhu and Foshan respectively, a fixed capital of more than 200 million yuan and more than 1,800 staff, wherein there are more than 200 professional technicians and managers. The company has more than 50 sets of professional automatic production equipment and more than 20 sets of detecting instruments introduced from Japan, and more than 400 sets of home-made production and detection instruments. It mainly produces 17AM-D, BR, 8AMC, 18AM, BW, BR-B6D temperature type automatic protectors, motor tachogenerators, temperature fuses, UL Electronic wire, power cord and motor insulation paper etc.

**主要展品 /Products**

17AM-D 系列热保护器是一种电流敏感性、温度感应保护装置, 与马达线圈串联, 保护器依据线圈温度及马达电流大小而变化, 当温度、电流增高时所产生的热量传递到双金属元件上, 达到预定动作温度设定值时, 双金属元件便迅速动作, 使触点断开, 切断电路。当马达线圈的温度下降到该产品的额定复位温度值时, 双金属元件又恢复到初始状态, 动触点闭合, 电路重新导通。

17AM-D series thermal protector is a current sensitive and temperature automatic response device. It is connected in series to the winding of motor. The protector changes with the temperature of winding and current of a motor. When the heat generated by t



# DALEN

**江苏达伦电子股份有限公司****Jiangsu Dalen Electronics Co., Ltd.**

地址: 江苏省常熟高新技术产业开发区白潭路 5 号 (215500)

电话 /Tel: 0512-52977992

传真 /Fax: 86-512-52977991

网址 /Web: <http://www.dalen-tech.com/>

达伦是光科技的创造公司, 先进的欧洲日本技术基因, 为品质打下坚实的基础, 创新研发了 3D 立体光技术、阿拉丁技术等, 给用户健康和高体验的智能家居产品, 实现人们的幸福生活。

达伦是华为生态的核心战略伙伴, 共同研发和面向市场推出一系列智能产品。

**主要展品 /Products**

智能灯 + 投影仪 + 音响 3 合 1, 卧室投影新趋势

**W4-4H01**星品电器  
THINKING  
DIFFERENT**江苏伽合电器有限公司****Jiangsu Jiahe Electric Appliance Co., Ltd**

地址: 江苏省南通市海门区正余镇正创路 99 号 (226153)

Add: No. 99, Zhengchuang Road, Zhengyu Town, Haimen District, Nantong City, Jiangsu Province

电话 /Tel: 18117019871

江苏伽合电器有限公司 (简称: 伽合电器), 成立于 2021 年, 注册资本 5000 万元。伽合电器是一家集产品的设计研发、生产销售为一体的小家电行业的创新型企业, 致力于全面提升国民生活品质, 满足消费者改善生活需求, 为消费者提供高品质的生活小家电及配套产品和服务。公司主要以研发、生产和销售电动类小家电产品、电热类小家电产品、电子类产品和日常家居用品为主, 主要产品包括养生壶、煮茶器、电陶炉、保温杯垫、榨汁杯等。

**主要展品 /Products**

公司产品涉及养生壶、煮茶器、便携式烧水杯、电陶炉、保温杯垫、便携式榨汁杯、料理锅、空气炸锅等。

**N3-3H21**国唯  
GUO WEI**江苏国唯智能机器人有限公司****Jiangsu Guo Wei Intelligent Robot Co. LTD**

地址: 昆山市玉山镇古城路 78 号欧洲工业区 L 号厂房

电话 /Tel: 17751729871

传真 /Fax: 0512-50173399

江苏国唯智能机器人有限公司成立于 2021 年, 注册资金 1000 万, 公司主要生产销售全智能无人厨房、家用电器制造、家用电器研发、家用电器安装服务等, 各种智能化家用电器, 公司在长期发展过程中以优良产品质量、良好的产品性能、先进的技术, 领先的技术优势, 为广大用户提供更多的性能先

进的优质产品。

**主要展品 /Products**

全智能无人厨房 是一款可以真正解放用户双手就可享用美味佳肴, 本款产品功能含有, 净菜储存、自动提示原料补充、全自动炒菜 (可爆炒、红烧、煲汤)、自动洗锅、炒菜区自动清理、抽油烟机、冷热水自动调整、垃圾粉碎、菜品保温区、全自动电饭煲 (自动洗米、加米、清洗)、智能洗碗机 (自动调整冷热水清洗、消毒)、水净化系统、手机 APP 远程控制等



LAO HUO JI

**智能净化火锅****江苏航嘉电器科技有限公司 (老火际智能无烟火锅)****N2-2A41 2A42**

地址: 江苏省扬州市邗江区金荣路 19 号 B8 栋 (225000)

电话 /Tel: 13805270079

航嘉电器是一家致力于改善家庭生活方式的电器开发公司, 专注于研发和生产高品质、高性能的家用电器产品。我们的目标是为消费者提供更加智能、便捷、舒适的家庭生活体验。

Hangjia Electric Appliance is an electrical appliance development company dedicated to improving the lifestyle of families, focusing on the development and production of high-quality, high-performance household electrical products. Our goal is to provide consumers with a more intelligent, convenient, and comfortable home life experience.

**主要展品 /Products**

随着科技的不断发展, 越来越多的黑科技被应用到各个领域。智能净化油烟电火锅是一款让人惊叹的黑科技产品。这款智能电火锅采用了先进的空气净化和降噪技术, 可以有效地减少人体皮肤对油烟的影响。智能净化油烟电火锅采用了空气净化技术, 可以快速净化室内空气中的有害物质, 如油烟等刺激性气味, 使得室内空气质量更加健康。该产品的油烟管道也采用了专业的过滤材料, 可以有效地减轻油烟对人体的刺激和伤害, 让食品更加健康。

With the continuous development of technology, more and more black technology is applied to various fields. Among them, the intelligent purifying lampblack electric hot pot is an amazing black technology product. This intelligent electric hot pot adopts advanced air purification and noise reduction technology, which can effectively reduce the impact of human skin on oil smoke. First of all, the intelligent purifying lampblack electric hotpot adopts air purification technology, which can quickly purify harmful substances in the indoor air, such as pungent odors such as lampblack, making the indoor air quality more healthy. At the same time, the oil fume pipe of this product also uses professional filtering materials, which can effectively reduce the stimulation and damage of oil fume to the human body, making the food healthier.

**N2-2B43 2B44 2B45 2B46**



**江苏黑森林环保科技有限公司**  
**SCHWARZWALD TECH CO.LTD**

**W2-2H76**

地址: 江苏张家港市金港后滕晨丰公路1号 (215600)

Add: No.1 Chenfeng road ,houcheng,Jingang,Zhangjiagang,jiangsu province

电话 /Tel: 86-0512-56372885-662

传真 /Fax: 86-0512-58289528-0

网址 /Web: www.schwarzwalddcn.com

黑森林环保科技有限公司,创办于德国,专注于设计、研发、生产、销售高端智能的空气净化系统。

目前黑森林已走入中国,中国总部配备了专业的生产研发实验室及生产设备、高标准的质量管控以及专业执着的研发团队,并先后获得国家知识产权局颁发的实用新型、发明、外观等专利30多项,通过ISO9001/TS16949/CE/CQC/ROHS等多项认证,并荣获中国制造之美的荣誉称号。

Since its inception ,adhering to the spirit of the craftsman Schwarzwald be handed down from age to age,the perfection of the product details control and the stringent requirements of quality,casting the superior quality of the products,the quality of sales achievement depends on the good quality,Schwarzwald's products have been sold to more than 30 countries and regions ,such as Germany ,the United states ,Singapore etc.

**主要展品 /Products**

公司拥有自主研发中心。致力于空气环境治理,产品涵盖新风系列(吸顶式、挂壁式、柜式、无管道新风机)和空气净化器系列(家用、商用、车载、桌面移动式)

Our company has our own R&D center . Committed to air environment management, the products cover Ventilation series (ceiling type, wall type, cabinet type, no pipeline new fan) and air purifier series (household, commercial, vehicle, desktop mobile).



**江苏华频电子科技有限公司**  
**JIANGSU HOPRIO ELECTRONIC TECHNOLOGY CO.,LTD**

**W1-1B52**

地址: 江苏省常州市武进国家高新区南区庙桥马杭南路19号华频控股

电话 /Tel: 18118349116

传真 /Fax: 0519-85529005

网址 /Web: www.hoprio.com.cn

江苏华频电子科技有限公司,隶属于华频控股集团,是国内早期研发、生产和销售高压无刷电机及变频控制器的民营科技企业,集无刷电机、高压变频控制器、动力系统成套解决方案输出等研发与生产、技术服务与品牌运营为一体。

**主要展品 /Products**

无刷电机,高压变频控制器,吹风机成品



雷利利

**江苏雷利电机股份有限公司**

**W2-2A08**

地址: 江苏省常州市武进区遥观镇钱家路19号 (213000)

电话 /Tel: 0519-85125976

传真 /Fax: 0519-85125976

网址 /Web: www.czleili.com

雷利电机,是一家具有广泛影响力的微电机产品研发设计、生产制造中国上市企业(股票代码:300660),已经形成以微型步进电机、同步电机、直流有刷电机、直流无刷电机、微型水泵等多种电机产品为主导,配套冲压、压铸等精密结构件、驱动控制模块、电机解决方案的综合业务能力。目前雷利的产品在家用电器行业已经具有较高的影响力,并持续推进在汽车零部件、工业控制、运动健康等多领域的协调发展。

**主要展品 /Products**

微型步进电机、同步电机、直流有刷电机、直流无刷电机、微型水泵等多种电机产品为主导,配套冲压、压铸等精密结构件、驱动控制模块、电机解决方案



**江苏美克斯智能科技有限公司**

**E3-3B11**

地址: 江苏南通

电话 /Tel: 15250652919

传真 /Fax: 15250652919

MKS,是一个由江苏纽唯盛机电有限公司与国际高端美容科技机构联手推出的一个高端美容护理仪器品牌。其因新颖、高效和健康的美容特性风靡全球,成为都市时尚女性的御用美肤神器。MKS便率先提出了物理美容的健康美肤理念,以“蒸”为主导,蒸走肌肤问题“蒸”出美丽。依靠多年的实力“蒸”功夫,以“天然、高效、自然”为追求,为注重生活品位的女性,提供专业、严谨、科学的美容护肤产品。

**主要展品 /Products**

蒸脸器系列、补水仪系列、洁面仪系列、美颜导入仪系列、吸黑头仪系列、磨脚 / 甲系列、美容美体系列、按摩仪系列、美发系列、家庭蒸汽清洁系列、其他系列



**江苏日成橡胶有限公司**  
**Jiangsu Richeng Rubber Co., Ltd**

**W4-4A25**

地址: 江苏常州 江苏省常州市天宁区焦溪工业园区 (213116)

Add: Jiaoxi Industrial Park, Tianning District, Changzhou City, Jiangsu Province

电话 /Tel: 4001588188

传真 /Fax: 051888900568

网址 /Web: www.richeng.com



江苏日成成立于1992年，是一家集“研发、生产、销售”于一体的综合性高科技企业。我们始终致力于为全球客户提供定制化橡胶制品研发与生产的一体化解决方案。我们以创新技术和满足用户需求为经营理念，依托30余年硅橡胶制品的专业设计和生产经验，竭诚为众多客户提供高品质的产品和全方位的服务。

Jiangsu RiCheng, founded in 1992, is a comprehensive high-tech enterprise integrating "research and development, production and sales". We are always committed to providing global customers with customized rubber products research and development and production of integrated solutions. We take innovative technology and meet the needs of users as the business philosophy, relying on more than 30 years of professional design and production experience of silicone rubber products, dedicated to provide many customers with high quality products and a full range of services.

#### 主要展品 /Products

硅橡胶挤出密封件、硅橡胶模压密封件、硅橡胶套管、硅橡胶接圈，各种各种胶料制品，各类定制配件  
Silicone extrusion seal, silicone molded seal, silicone casing, silicone contact ring, all kinds of rubber material products, all kinds of custom accessories



### 江苏双鹿电器有限公司 Jiangsu SONLU Electric Appliance Co., Ltd.

W1-1C51

地址：江苏省宿迁市经济技术开发区南京路899号  
电话 /Tel: 18502118358  
网址 /Web: <http://www.sonlu.com.cn/#>

双鹿、上菱品牌前身分别是上海电冰箱厂及上海电冰箱二厂创建于1979年和1985年专注于冰箱、冷柜、空调、高端厨电等智能家电的研发和制造。双鹿上菱集团以上海为总部，下辖上海双鹿电器有限公司、上海上菱电器制造有限公司等多家子公司，在上海松江、江苏宿迁、江苏新沂和海外孟加拉国布局四大制造基地，年产冰箱、冷柜、空调等超过600万台，拥有员工团队3000余人。

The predecessors of Sonlu and Shangling are Shanghai Refrigerator Factory and Shanghai Refrigerator Factory 2, which were established in 1979 and 1985. It is focus on the research, development and manufacturing of smart appliances such as refrigerators, freezers, air conditioners, and high-end kitchen appliances. Headquartered in Shanghai, the Group has subsidiaries such as Shanghai Sonlu Electric Appliance Co., Ltd. and Shanghai Shangling Electric Appliance Manufacturing Co., Ltd. It has four production bases in Shanghai, Suqian, Xinyi, and Bangladesh, with yearly more than an 6M pcs intelligent home appliance and more than 3000 employees.

#### 主要展品 /Products

冰箱、冷柜、空调、高端厨电等智能家电  
Refrigerators, freezers, air conditioners, high-end kitchen appliances and other smart home appliances



### 江苏顺发电器有限公司

N2-2A55 2A56

地址：江苏省丹阳市吕城镇顺发大道1号  
电话 /Tel: 051186821082

江苏顺发电器有限公司，成立于2009年，是一家集营销、设计、开发、制造为一体的厨房小家电企业。公司注册资金1000万元，厂房面积40000平方米，员工近400名，拥有专业的产品研发及质量管理团队，配有先进的设备仪器和完善的检测手段，具有模具设计制造、塑胶零件生产、五金零件生产及十二条成品装配线的综合能力。

公司产品有电热水壶、榨汁机、搅拌机、洗手液机、蒸汽烤箱、蒸馏水机等产品系列。

#### 主要展品 /Products

电热水壶，榨汁机，搅拌机，蒸汽烤箱



### 江苏瓦恩新材料科技有限公司 Jiangsu Waen New Material Technology Co., Ltd

W5-5B41

地址：如皋市城北街道十里墩村八组50号(201601)  
Add: No. 50, Group 8, Shilidun Village, Chengbei Street, Rugao  
电话 /Tel: 0513-89070499  
传真 /Fax: 0513-89070499  
网址 /Web: [www.jswaen.com](http://www.jswaen.com)

瓦恩新材料专注于电子市场胶黏剂的创新和应用，我们致力于开发新的解决方案并对胶黏剂技术不断进行创新，通过可靠的产品质量和专业时效性的技术服务，为客户提供最佳的客制化的整体粘合技术解决方案，为客户创造最大价值，成为客户可信赖的合作伙伴。

Vaen New Materials focuses on the innovation and application of adhesives in the electronic market. We are committed to developing new solutions and constantly innovating adhesive technology. Through reliable product quality and professional and timely technical services, we provide customers with the best customized overall adhesive technology solutions, create maximum value for customers, and become customers' trusted partners.

#### 主要展品 /Products

1. Waen@EP901A/B 系双组份常温固化型环氧树脂灌封胶，固化后表面光亮平整、电绝缘性优异，适用于各种电子电气元器件及水处理模块的封装保护。
2. Waen@HN500A/B 系双组份常温或加热固化型长耐候透明无填料体系柔性封装料。混合后操作工艺性好，产品在较短的时间内固化，形成保护，固化后环保、透明度高、韧性好，适用于保护在潮湿、震动的环境运行的电子产品。

1. Waen@EP901A/B is a two-component normal-temperature curing epoxy resin potting adhesive. After curing, the surface is bright and smooth, and the electrical insulation is excellent. It is applicable to the packaging and protection of various electronic and electrical components and water treatment modules.
2. Waen@HN500A/B is a two-component normal temperature or heating curing long weatherproof transparent filler free flexible packaging material. After mixing, the operation process is good. The

product is solidified in a short time to form protection. After curing, it is environmentally friendly, transparent, and flexible. It is suitable for protecting electronic products operating in a humid and vibrating environment.



伟恒玻璃

**江苏伟恒玻璃制造有限公司****Jiangsu Weiheng Glass Manufacturing Co., Ltd**

地址: 江苏省扬州市宝应县望直港镇工业集中区新区迎风路

Add: Baoying, Yangzhou City, Jiangsu Province

电话 /Tel: 0514-88466108

网址 /Web: www.weihengglass.com

江苏伟恒玻璃制造有限公司创立于 2015 年, 是一家专业从事各类家电玻璃面板、搁板、玻璃门及触摸屏的研发、加工、销售的企业。坐落于宝应县望直港镇, 占地 30 亩, 交通便利。公司拥有高精密的自动生产设备和雄厚技术力量, 是国际上多家知名品牌家电公司的核心供应商(如日本松下、日本三菱、日本三洋等)。产品主要出口到日本、印度尼西亚、台湾、越南、巴西、墨西哥等国家和地区。

Jiangsu Weiheng Glass Manufacturing Co., Ltd, set up in 2015, is a joint-stock private enterprise specializing in the research, development and processing we sales of various home appliance glass panels, glass trays, glass doors and touch screens.

Weiheng located at Baoying, Yangzhou City, Jiangsu Province, covers 20000 square meters area. When you in Shanghai city it just takes only 2.5 hours to Weiheng.

Weiheng not only had many of high-precision process equipments but also the technical force are strong. It is the core supplier of many well-known home appliance companies in the world (such as Panasonic, Mitsubishi, Sanyo). The products are mainly exported to Japan, Indonesia, Taiwan, Vietnam, Brazil, Mexico and other countries or regions.

Weiheng pursues quality first, the products quality has been approved by many customers.

Weiheng was identified as the world's first horizontal supplier by Panasonic in 2019, and also be identified as "National high-tech enterprise".

**主要展品 /Products**

冰箱面板玻璃, 洗衣机面板玻璃, 搁板玻璃, 烤箱面板玻璃, 燃气灶具面板玻璃, 油烟机面板玻璃

Refrigerator panel glass, Washing machine panel glass, Tray glass, Oven panel glass, Gas cooker panel glass, Kitchen hood panel glass



稳润光电

**江苏稳润光电有限公司****Jiangsu Wenrun Optoelectronic Co., Ltd**

地址: 江苏省镇江市丁卯开发区正德路 88 号 (212000)

Add: NO.88 Zhende Road, Dingmao Development Zone, Zhenjiang, Jiangsu 212009, China

电话 /Tel: 0511-80867013

传真 /Fax: 0511-88891170

网址 /Web: www.wenrun.com

江苏稳润光电有限公司是国家高新技术企业, 是国内以 LED 封装器件为最大的、最专业的 LED 制造商之一。稳润光电在 LED 领域积累了近 30 年专业制造经验, 产品从传统 LED 发光管、数码显示屏

到新兴的照明用大功率白光 LED、车用 LED 照明产品等, 其中器件的规模化生产能力方面代表着国内最高水平。

As a state hi-tech enterprise, Jiangsu Wenrun Optoelectronic Co., Ltd is one of the largest and the most professional manufacturers specialized in LED encapsulation in China. With professional experience in LED field for almost 30 years, we produce from traditional LED lamps and LED displays to high power white LED for lighting, Automotive lighting applications, and the large-scale productivity of LED components has reached the highest level in China.

**主要展品 /Products**标准发光二极管, 字符显示器发光二极管, 表贴式发光二极管, 大功率发光二极管, 食人鱼发光二极管  
STANDARD LED, DISPLAY LED, SMD LED, HIGH-POWER LED, HIGH FLUX LED中信华  
ZHONGXINHUA**江苏中信华电子科技有限公司****Jiansu Zhongxinhua Electronics Co Ltd**

地址: 江苏省淮安市涟水县经济开发区兴盛路 2 号 (223400)

电话 /Tel: 0755-33820988

传真 /Fax: 0755-33820989

网址 /Web: www.zxhgroup.com

中信华创立于 1999 年, 十多年来, 坚持“创建中信华国际化品牌”为企业目标与理想, 致力于打造研发及生产印制电路板 (PCB) 的高科技企业。历经十多年的快速发展, 如今的中信华已发展成为在中国大陆地区拥有深圳、惠州、江西、江苏四处生产基地、产品类型以单面、双面 FR-4、多层板为主的大型印制电路板 (PCB) 的生产企业。

**主要展品 /Products**

产品类型: 单面、双面 FR-4、多层板

**江西格林循环产业股份有限公司****Jiangxi Green Recycling Co., Ltd.**

地址: 江西省丰城市资源循环利用产业基地 (331100)

Add: Resources Recycling Industrial Base, Fengcheng City, Jiangxi Province

电话 /Tel: 0795-6833888

传真 /Fax: 0795-6833666

网址 /Web: www.ger.com.cn

江西格林循环产业股份有限公司成立于 2010 年 5 月, 是著名循环经济产业集团 - 格林美 (股票代码 002340) 的以电子废弃物综合利用和再生改性塑料制造为主业的控股公司。格林循环多年来不断开拓废塑料循环与改性技术, 形成了“废旧产品 - 回收拆解 - 资源化 - 改性再造 - 新产品”的废塑料产品闭环循环经济模式, 再生改性塑料规划产能达 30 万吨, 产品进入世界 500 强的供应链, 成为中国领先的再生塑料改性塑料制造商。

W1-1C92

W3-3B33 3B34

W5-5E81

W4-4H61



Founded in May 2010, Jiangxi Green Recycling Co., Ltd. (GER) is a holding company of GEM (stock code 002340), a famous recycling economy industry group, mainly engaged in the comprehensive utilization of electronic waste and the manufacture of recycled modified plastics. Over the years, GER has always constantly developed the recycling and modification technology of waste plastics, a closed-circuit recycling economic model of waste plastic products has been formed, which is "waste products-recycling and dismantling - recycling - modification and reproduction-new products". The production capacity of recycled and modified plastics has reached 300,000 tons, and its products have entered the supply chain of the world's top 500, making it a leading manufacturer of recycled and modified plastics in China.

#### 主要展品 /Products

高性能 PP 系列再生塑料颗粒、高性能 ABS 系列再生塑料颗粒、高性能 PS 系列再生塑料颗粒、高性能 PE 系列再生塑料颗粒、高性能 PMMA 系列再生塑料颗粒、高性能 PC 系列再生塑料颗粒

High performance PP series recycled plastic granules \ High performance ABS series recycled plastic granules \ High performance PS series recycled plastic granules \ High performance PE series recycled plastic granules \ High performance PMMA series recycled plastic granules \ High performance PC series recycled plastic granules



#### 铂锐思科

#### 江西亨成实业有限公司

#### Jiangxi Hengcheng Industrial Co., Ltd

W4-4A56

地址：江西省抚州市东乡区瀟山岗工业区杭州路7号(331800)

Add: No. 7 Hangzhou Road, Yuanshangang Industrial Zone, Dongxiang District, Fuzhou City, Jiangxi Province

电话 /Tel: 19916027227

网址 /Web: www.hcecn.com

温州市亨成电子有限公司创立于2002年，创立时以生产微电机配件为主营产品，经过几年发展壮大，现已是一家集模具开发、加工制造、经营销售为一体的贯流风机生产型企业，发展成为贯流风机为主导产品的实力型公司，并凭借独特的产品领域在横流风扇行业建立了市场主导地位。公司于2012年在江西自建一座30000平方具有无尘车间，自动化流水线，办公大楼，员工宿舍及休闲娱乐运动场的现代化工厂，现有模具制造及生产设备数十台。

Wenzhou Hengcheng Electronics Co., Ltd. was founded in 2002 and was mainly engaged in the production of micro motor parts. After several years of development and expansion, it is now a through-flow fan production enterprise integrating mold development, processing, manufacturing, and sales. It has developed into a powerful company with through-flow fans as the leading product, and has established a market leading position in the crossflow fan industry with its unique product field. In 2012, the company built a 30000 square meter modern chemical factory in Jiangxi Province with dust-free workshops, automated assembly lines, office buildings, employee dormitories, and recreational sports grounds. Currently, it has dozens of mold manufacturing and production equipment, nearly 100 employees, and over 1000 sets of molds. Its products have covered the Yangtze River Delta, Pearl River Delta, and all over the country.

#### 主要展品 /Products

贯流风机，横流风机  
Cross flow fan



#### 江西联创南分科技有限公司

#### Jiangxi Lianchuang South Branch Technology Co.,Ltd.

N4-4B20

地址：江西省南昌市高新区京东大道168号101号楼4楼(330029)

Add: 4th Floor, 101 Building, No.168 Jingdong Avenue, High-tech Development Zone, Nanchang

电话 /Tel: 0791-88169288

传真 /Fax: 0791-88162002

网址 /Web: http://www.jxlcnf.com

江西联创南分科技有限公司(原江西联创光电南昌分公司)，坐落在江西省南昌市南昌高新技术产业开发区联创光电科技园区内，有员工200余人，其中专业技术人员50余人，固定资产3468.93万元。

定位于中高端LED数码管/显示模块、智能显示组件、紫/红外功能模块产品的研发、生产及销售。年销售额1.2亿；

拥有各类LED平面显示器件发明/实用新型等专利30余件；

五标一体化管理体系运行的国家高新技术企业。

Jiangxi LIANCHUANG South Branch Technology Co.,Ltd.It was located in LIANCHUANG Opto electronics Technology Park, Nanchang High-tech Development Zone, Nanchang City, Jiangxi Province. It has more than 200 employees, including more than 100 professional and technical personnel and 80 million yuan in fixed assets.

We have a strong R&D ability, along with a perfect product sales network and efficient after-sales service system. Our company is committed to the production of energy-saving, green, environmental protection, high life LED products.

Our company focus on the high-end LED digital tube/display module, intelligent display components, infrared function module R&D, production and sales. It has more than 30 patents of all kinds of LED flat display device invention/utility model and 5 sets of control system operating. It is a national high-tech enterprise with high quality assurance.

#### 主要展品 /Products

Led module display, 7segment Led display, Tube display, UVC-LED display



#### 江阴佩尔科技有限公司

#### PEIERTECH

W3-3B22

地址：江苏江阴国家高新区东盛西路6号D4座

电话 /Tel: 051086400125

网址 /Web: www.peiertech.com

江阴佩尔科技有限公司(简称“佩尔科技”)，成立于2002年。公司拥有镍钛方面的专有技术和团队，提供医用级镍钛材料(镍钛丝、镍钛管、镍钛绳、高温驱动丝)和合同制造服务(合同制造包括各类镍钛部件：耳机耳挂、高精度弹簧，密封件，柔性承载件，超弹性部件、记忆性零件等)。

#### 主要展品 /Products

镍钛合金丝，镍钛合金管，镍钛驱动丝，镍钛合金绳，镍钛弹簧，镍钛部件(耳机耳挂定型件、高精度弹簧，密封件，柔性承载件，超弹性部件、记忆性零件等)



万钰

**江阴市万华金属实业有限公司**  
**Jiangyin Wanhua Metal Industry Co., Ltd**地址: 江苏省无锡市江阴市璜土镇岐上路 8 号  
电话 /Tel: 18351239203

我公司主要生产不锈钢排烟管道, 各种防倒风阀门。

**主要展品 /Products**

热水器排烟管, 油烟机止回阀, 新风管道阀

N1-1A22



John Guest®

**接格(上海)贸易有限公司**  
**John Guest (Shanghai) Trading Company Ltd.**地址: 淮海中路 1 号 1910 室 (200021)  
电话 /Tel: 86-21-33100016  
传真 /Fax: 86-21-33100016  
网址 /Web: <https://www.johnguest.com/>

John Guest 作为一家领先的快插式接头、管道和其他液控产品生产商, 在全球范围内久负盛名。这一良好的声誉来自于其始终如一地生产高质量产品, 并不断致力于价值工程和产品开发。

John Guest 产品的设计与生产均在位于伦敦的现代化专业制造中心完成, 以严格的控制措施确保只生产高质量产品。

正是对质量的不懈追求, John Guest 获得了众多知名测试和认证机构的认可。

John Guest has a long established reputation as a world leading manufacturer of push-fit fittings, tube and other fluid control products. A reputation built on producing consistently high quality products with an ongoing commitment to value engineering and product development.

A commitment to quality is at the heart of the John Guest philosophy.

The strict control is maintained by virtue of the fact that design and manufacture is carried out in modern purpose built manufacturing centres in West London and at Maidenhead in Berkshire.

Maintaining control over the whole process from initial tool design and tool making through to final assembly and testing ensuring that only products of high quality are produced.

The company believe it is this commitment to quality that has led to it receiving prestigious awards from many of the world's leading testing and approvals organisations.

John Guest is a preferred supplier to many international companies.

**主要展品 /Products**

各种规格的快插接头, 球阀、单向阀, 以及相应的 LLDPE 软管和 PEX 管产品

Various specifications of push-fit fittings, ball valves, check valves, and LLDPE and PEX pipes

N4-4A30

**捷和环境科技(深圳)有限公司**  
**Chiaphua Environmental Technology (Shenzhen) Co., Ltd**地址: 深圳市宝安区石岩街道水田社区捷和工业城 A 栋 2 楼 (518101)  
电话 /Tel: 755-29818288  
传真 /Fax: 755-29818288  
网址 /Web: [www.CETSZ.CN](http://www.CETSZ.CN)

捷和环境科技(深圳)有限公司于 2015 年 10 月由香港捷和实业有限公司和台资公司联合建立, 2018 年 4 月由香港捷和实业有限公司全资拥有, 是一家集设计、制造、销售空气净化技术产品的港资环保科技企业, 生产基地设于深圳石岩自身拥有的捷和工业城。产品和解决方案已应用于全球, 为世界空气净化的品牌商和 OEM 厂商提供优质产品及全面解决方案。

公司厂房总面积 12000 m<sup>2</sup>, 年生产量能超过 300 万个各式过滤产品。**主要展品 /Products**

主要生产空气净化器滤网, 新风滤网, 加湿器滤芯, 吸尘器滤芯等

W5-5B20

**捷赛® Gemside®****捷赛厨电(北京)科技有限公司**  
**Gemside Kitchen Appliances (Beijing) Co., Ltd**地址: 北京市朝阳区盈科中心 A 栋 715  
电话 /Tel: 010-65089034

捷赛专注研究中烹饪智能化, 于 2005 年推出第一代自动烹饪锅, 是智能烹饪领域的开拓者和领跑者。捷赛创新发明了一系列智能烹饪类小家电产品及厨具产品, 具有很强的创新研发经验和能力, 在顺德拥有自己的生产基地, 持有发明专利超过 80 项、实用新型专利 3 项、外观设计专利 8 项、著作权 30 项、注册商标超过 200 项。捷赛产品销量在京东、淘宝等电商平台的细分领域中排名前列。

**主要展品 /Products**

捷赛主要产品全新升级为具有灵活人机交互功能的智能烹饪系列, 提升厨房空间使用效率及美化厨房美观度的无尾系列, 同时包括多功能电饭煲、电火锅、聚嗨盘、电煮锅、养生锅、随身煲、榨汁杯、电热水壶、空气炸锅、牛扒机、煮蛋器、电蒸锅等全系列厨房小家电产品。

N3-3E51

**金枫林电器(无锡)有限公司**  
**Golden Maples Electric(Wuxi) Co., Ltd**地址: 无锡市新吴区华友工业园华友一路八号 (214000)  
Add: D3 Area Huayou Industrial Park, Wuxi, Jiangsu, China  
电话 /Tel: 051085309999  
传真 /Fax: 051085309968  
网址 /Web: [www.gunny.com.cn](http://www.gunny.com.cn)

公司成立于 1996 年, 公司专业从事各类智能家电系列控制器的高新技术企业, 例如吊顶电器控制器, 智能卫浴控制器、各类卫浴遥控器。在这些领域, 公司拥有多项专利, 产品通过 CCC、CE、UL

N1-1B23

等多国认证。

公司拥有国际先进水平的自动化生产流水线,包括高速全自动 SMT 贴片机,无铅全电脑波峰焊机,回流焊机以及全自动检测流水线。公司严格按照 ISO9001 质量保证体系来规范企业质量管理。

主要展品 /Products

智能卫浴控制器、各类卫浴遥控器



金华依娃电器有限公司

Jinhua Yiwa Electric Appliance CO., LTD

N1-1B37

地址:浙江省金华市金东区鞋塘镇正涵北街9号

Add: No.9 Zhengnan Road, Xietang Town, Jindong District, Jinhua City, Zhejiang Province, CHINA

电话 /Tel: 0579-82991188

我司主营电热干衣架,电热毛巾架,电热干鞋架等铝制品,产品现 90% 出口至欧洲,澳洲,中东等地区。工贸一体并自有铝厂。厂区已通过 BSCI, SGS, ISO 各项认证,现持有 CE, EMC, ROHS, SAA, UKCA, IP44 等证书。

Electric clothes drying rack, towel warmer, shoes drying rack and other aluminum products.

BSCI, SGS, ISO, CE, EMC, ROHS, SAA, UKCA and IP44 are held.

The capacity can reach 15000 pieces for each series per month.

主要展品 /Products

电热干衣架, 电热毛巾架, 电热干鞋架以及其他铝制品。

Electric clothes drying rack, towel warmer, shoes drying rack and other aluminum products.



金牌厨柜家居科技股份有限公司

GoldenHome Living Co., Ltd.

N3-3C01 3C11

地址:福建省厦门市同安区工业集中区同安园集和路 190 号金牌厨柜总部 (361100)

电话 /Tel: 0592-5580372

传真 /Fax: 0592-5580372

网址 /Web: <https://www.canc.com.cn/>

金牌厨柜家居科技股份有限公司(简称金牌)创立于 1999 年(股票代码: 603180),是国内高端整体厨柜及定制家居的专业服务商,专业从事整体厨柜及定制家居的研发、设计、生产、销售、安装及售后等整体服务。是全国工商联家具厨柜专委会会长单位,中国五金制品协会整体厨房分会会长单位。

金牌在全球有超 2500 家高端品牌专卖店,旗下拥有厨柜、衣柜、木门等多个子品类,为用户打造一站式定制家装体验。

主要展品 /Products

i-Kitchen 3.0 智慧厨房、嵌入式智慧屏、智慧抽屉、智慧升降桌、集成灶、集成水槽、嵌入式蒸烤箱、自由嵌入式冰箱、全屋水系统等



精英汇信息科技(青岛)有限公司

Elitehui Information Technology Company

W3-3H11

地址:山东省青岛市崂山区劲松七路 236 号瀚晨优创 228 (266000)

电话 /Tel: 13687608222

网址 /Web: [www.elitehui.com](http://www.elitehui.com)

精英汇-以家电圈精英汇协会为依托,打通家电生态圈上下游产业链,赋能制造企业,共享生态平台,做全球生态互联网平台的缔造者和社群电商的领导者。精英汇旗下两大平台:菁多多生态互联网商城和蛭子优品社群精品电商。菁多多主打家电生态 B2B 业务;蛭子优品主打家电生态 M2B2C 业务。

Elite Club - relying on elite Club of home Appliance circle, open up upstream and downstream industrial chain of home appliance circle, empower intelligent manufacturing enterprises, share ecological platform, and become the founder of global ecological Internet platform and the leader of community e-commerce. Elite collection of its two major platforms: Jingduo Ecological Internet mall and Razor Clam subexcellent community boutique e-commerce. Jingduo is the main home appliance ecological B2B business; Razor clam excellent product advocate home appliance ecology M2B2C business.

主要展品 /Products

菁多多-以家电圈精英汇协会为依托,主打生态互联网商城,致力于打通家电生态圈上下游产业链,做上下游产业链的供应链服务、集中采购和供应链金融服务。

蛭子优品-精英汇旗下家电新零售生态服务平台,是由安徽省信息家电行业协会和家电圈精英汇共同孵化和打造的互联网平台。蛭子科技旨在打造全国最专业的家电新零售生态服务平台,为厂家搭建最大的流量平台,为商家搭建最专业的家电 M2C 直播平台。

Jingduo - based on the elite Association of home appliance circle, the main ecological Internet mall is committed to opening up the upstream and downstream industrial chain of home appliance ecosystem, and providing supply chain services, centralized procurement and supply chain financial services for upstream and downstream industrial chain.

Razor clam's new retail ecological service platform of home appliance is an Internet platform incubated and created by Anhui Information Home Appliance Industry Association and Home Appliance Circle Elite. Razor clam technology aims to build the most professional new retail ecological service platform for home appliances in China, build the largest flow platform for manufacturers, and build the most professional M2C live platform for businesses.

Joyoung 九阳

九阳股份有限公司

Joyoung

N3-3F11

地址:山东省济南市槐荫区美里路 999 号 (310018)

电话 /Tel: 057181639128

九阳,品质小家电领导品牌。1994 年,九阳发明世界第一台豆浆机,让千家万户方便喝上了豆浆。28 年来,九阳秉承健康、创新的核心 DNA,经历了“三个十年”的发展:

第一个十年(1994—2004 年),发明豆浆机,让豆浆机走进千家万户。第二个十年(2004 年—2014 年),从豆浆机到多品类,做厨房小家电的领导者。第三个十年(2014 年至今),成长为品质小



家电领导品牌。

World's First Soymilk Maker Invented by Joyoung in 1994 ; The invention of soymilk maker, provides a convenient source of protein for Chinese, Joyoung pioneered the household soymilk machine industry. 1994-2004, Invented soymilk maker, the soymilk machine came into the homes of ordinary people; 2004-2014, From soymilk maker to the leader in kitchen appliances. 2014-now, A leader in high-quality small household appliances

#### 主要展品 /Products

豆浆机、破壁机、电饭煲、净水器、空气炸锅、炊具等  
soymilk maker, blenders



#### 巨福五金塑料(深圳)有限公司

#### GALFORD HARDWARES&PLASTIC (SHENZHEN) CO., LTD

W3-3A14

地址: 深圳市光明区新湖街道办楼村社区鲤鱼河工业区红银路 149 号  
电话 /Tel: 13688845673

巨福公司为 1985 年于台湾创立, 以「为客户与公司创造最大利益」为企业使命, 提供专业的技术为客户提供质量与价格优良的产品, 2017 年公司开始转型投入更多自动化设备。积极实现稳定交期, 卓越质量之产品。

2022 年, 巨福五金设立家电部门, 以「让我们的产品为消费者提供更舒适生活」为目标, 期望在家电市场开出一条新的道路。

#### 主要展品 /Products

多功能加湿机  
暖风机

## 咖啡自由

KAXFREE

#### 咖啡自由

#### KAXFREE

E2-2H66

地址: 苏州工业园区 428 号苏春工业坊 C 幢  
电话 /Tel: 13372106391

咖啡自由隶属于苏州咖乐美咖啡机科技有限公司, 是国内专业的家用咖啡机品牌。成立至今, 咖啡自由持续围绕着咖啡风味与全自动咖啡机功能不断探索。作为新一代智能家用全自动咖啡机的新锐品牌, 致力于通过打造智能家用全自动咖啡机和咖啡+的自由生活体验, 将智能科技、精致设计、咖啡口感、全心服务, 环保再生的理念融入到产品的开发之中。希望通过创造高品质又与众不同的产品, 打造咖啡机生活的新场景, 为咖啡机行业开创更多可能!

#### 主要展品 /Products

咖啡自由热恋系列热恋 5 家用意式全自动咖啡机

## KÄRCHER

#### 卡赫贸易(中国)有限公司

#### Kaercher Trading (China) Co.,Ltd.

E1-1F21

地址: 江苏省常熟市东南开发区东南大道 221 号 (215500)

Add: 221 Southeast Avenue, Southeast Development Zone, Changshu City,  
Jiangsu Province, China

电话 /Tel: 4008801060

传真 /Fax: 50768903

网址 /Web: www.karcher.cn

Kärcher 德国卡赫成立于 1935 年, 总部位于德国斯图加特, 是全球最大清洁设备和清洁解决方案提供商。88 年来, 凭借创新超前的研发体系、臻至完美的品质理念, 为全球数百万企业用户提供持续可靠的清洁保障, 是数十亿热爱生活、追求品质的家庭所信赖的清洁伙伴。自进入中国市场以来, 卡赫一直致力于以欧美健康标准改善中国用户的居家环境, 积极分享专业、高效且富有趣味的洁净生活方式, 用科技呵护生命健康, 畅享美好生活!

Kärcher was born in Stuttgart, Germany in 1935. The founder, Alfred Kärcher, developed Europe's first hot-water high-pressure cleaner in 1950, laying the Kärcher status of global leading company in cleaning industry. As the world's largest supplier of cleaning equipment and cleaning solution, Kärcher has more than 3,000 product lines including home & garden products, professional products for hotel, industry, government, military and environmental protection, accessories and other types of products. Those outstanding products have obtained more than 1,999 patents and registered designs.

Over the past 88 years, Kärcher has provided reliable and efficient cleaning solutions and lifestyle for millions of corporate and family customers around the world. Since Kärcher entered China, it is committed to improving the home life of Chinese users with world-class standards. And Kärcher is devoted to using modern technology to care for health, which makes life and cleaning full of joy!

#### 主要展品 /Products

多功能蒸汽清洁机 SC5 Deluxe 搭载卡赫特有的封闭式加热系统, 炉内温度可达 164°C, 释放 1.5-2 米射程的 4bar 超高压蒸汽, 能有效杀灭病毒和细菌, 为万千家庭带来健康、安全的生活环境。高饱和的蒸汽可强效去除各种顽固污渍, 通过对清洁刷头的不同组合方式, 能实现多样化的深度清洁需求, 轻松完成全屋深度杀菌清洁工作。

与传统化学消毒相比, 卡赫蒸汽清洁科技更环保, 只需水和电, 对有小孩和过敏患者家庭很友好。

The SC 5 Deluxe steam cleaner cleans at 4 bar, is permanently refillable and guarantees uninterrupted cleaning thanks to its detachable water tank. The steam cleaner can effectively remove viruses and bacteria on hard surfaces, bringing a healthy and safe living environment for thousands of families. At the same time, the highly saturated steam can strongly remove a variety of stubborn dirt, through the different combinations of accessories, can satisfy the needs of deep cleaning.

Compared to traditional chemical disinfection, Kärcher's steam cleaning technology is greener, and the entire process requires only water and electricity, making it very friendly to families with children and allergy sufferers.



## NWT

## 开平威德电器有限公司

W1-1D98

地址: 广东省开平市水口镇金山东大道 52 号 2 座 (529300)

电话 /Tel: 18929076175

网址 /Web: <http://www.newwidetech.com.cn>

開平威德電器有限公司是擁有 30 年專業生產移動空調、除濕機、分體空調的綜合性電器製造台資企業集團所創立的全資子公司，主要經營移動空調、除濕機、等產品的研發、生產、銷售。一直致力於客戶需求為導向，通過自主創新生產高品質、高精尖的產品。生產產品自給率達到 95% 以上，掌握該品類的核心壓縮機技術。超 30 年的產品研發經驗最大限度地滿足客戶及全球市場需求。是衆多世界 500 強企業長期合作 OEM 業務的目標工廠。

## 主要展品 /Products

除濕機，移動空調，電風扇，空氣淨化器等...

## KONKA 康佳

## 康佳集团股份有限公司

W3-3C11

## KONKA Group Co., Ltd.

地址: 深圳市南山区科技园南十二路 28 号康佳研发大厦 (518053)

Add: KONKA R&amp;D Bulding, No.28 Keji south road 12th, Nanshan district, Shenzhen

电话 /Tel: 075586710160

传真 /Fax: 075586710160

网址 /Web: [www.konka.com](http://www.konka.com)

康佳集团成立于 1980 年 5 月 21 日，前身是“广东光明华侨电子工业公司”，是中国改革开放后诞生的第一家中外合资电子企业。1992 年在深圳证券交易所上市，现有注册资本 24.08 亿，华侨城集团为公司第一大股东。康佳是一家以科技创新为驱动的平台型公司，业务范围涵盖消费电子（彩电、白电、手机）、半导体科技、新能源业务、产业园区业务及投资金融业务。

## 主要展品 /Products

消费电子类



## 科大讯飞股份有限公司

W3-3F71

## iFLYTEK CO., LTD.

地址: 中国安徽省合肥市望江西路 666 号 (230000)

Add: 666 West Wangjiang Road, Hefei, Anhui, China

电话 /Tel: 4000-199-199

传真 /Fax: 0551-65331801

网址 /Web: [www.iflytek.com](http://www.iflytek.com)

科大讯飞股份有限公司成立于 1999 年，是亚太地区知名的智能语音和人工智能上市企业。自成立以来，一直从事智能语音、自然语言理解、计算机视觉等核心技术研究并保持了国际前沿技术水平；积极推动人工智能产品和行业应用落地，致力让机器“能听会说，能理解会思考”，用人工智能建设美好世界。

Founded in 1999, iFLYTEK is a well-known listed company in intelligent speech and artificial intelligence technologies in the Asia-Pacific region. Since its establishment, the company is devoted to cornerstone research in technologies including intelligent speech, natural language understanding and computer vision and has maintained a world-leading position in those domains. The company actively promotes the development of AI products and their sector-based applications, with visions of enabling machines to listen and speak, understand and think, and creating a better world with artificial intelligence.

## 主要展品 /Products

基于拥有自主知识产权的核心技术，2010 年，科大讯飞在业界发布以智能语音和人机交互为核心的人工智能开放平台——讯飞开放平台，为开发者提供一站式人工智能解决方案。截至 2021 年 11 月 31 日，讯飞开放平台已开放 447 项 AI 产品及能力，聚集超过 283 万开发者团队，总应用数超过 133 万，累计覆盖终端设备数 [ 累计终端设备数: 2010 年至今，平台累计服务过的终端设备个数 ]33 亿 +。

Based on its core technologies and intellectual property, the company launched in 2010 the iFLYTEK Open Platform centered on intelligent speech and human-computer interaction, providing developers with one-stop AI solutions. As of November 30, 2021, the iFLYTEK Open Platform has opened 447 AI products and capabilities, gathering more than 2.83 million developer teams and more than 1.3 million applications that have been installed on over 3.3 billion terminal devices.



## 科立工业 (深圳) 有限公司

E3-3B13 3B14

## Fortech Industrial (shenzhen) Limited

地址: 深圳市宝安区沙井街道衙边社区衙边学子围巨基工业园 D 栋 D713 (518105)

电话 /Tel: 075523205420

传真 /Fax: 075523061042

网址 /Web: <http://www.fortechind.com>

科立工业 (深圳) 有限公司的生产工厂位于中国深圳。拥有先进的内部检测设备，研发团队，技术工程师团队，全面支持客户。公司产品: 翘板开关、微动开关、旋转开关、指示灯、交流电源开关、讯号开关、电源插座等。

科立工业 (深圳) 有限公司认同环境保护是保持健康和安全的共同使命。我们的产品同时符合 ROHS 指令还达到了 UL, CSA (cUL), ENEC, CB, CQC, CCC, PSE (JET), KC 等国际安全标准。

## 主要展品 /Products

公司产品: 翘板开关、微动开关、旋转开关、指示灯、交流电源开关、讯号开关、电源插座等。



## COMOTEC

### 科泰模型

科泰模型科技(苏州)有限公司  
COMOTEC (Suzhou) CORPORATION

W1-1D96

地址: 江苏省苏州市昆山市千灯镇中节路 502 号  
电话 /Tel: 13915759205  
网址 /Web: www.comotec.net

科泰模型科技(苏州)有限公司, 专业制作各类手板模型、小批量定制。包括数码产品手板模型、家电手板模型、医疗器械手板模型、汽车零部件手板模型等。公司位于江苏省苏州市昆山市, 拥有多台精密 CNC 加工中心、3D 打印设备、全自动真空复模机等精密加工设备, 配套有精密车床、铣床、喷砂机及表面处理设备, 生产加工及表面处理工艺齐全, 能够快速为您提供一站式手板模型完整解决方案。主营: 各类塑胶手板、五金手板、模具注塑等。

#### 主要展品 /Products

专业制作各类手板模型、小批量定制。包括数码产品手板模型、家电手板模型、医疗器械手板模型、汽车零部件手板模型等。各类塑胶手板、五金手板、CNC 加工、3D 打印、真空复模、钣金、模具注塑等。



科沃斯机器人股份有限公司  
ECOVACS Robotics Co., Ltd.

E1-1F11

地址: 江苏省苏州市友翔路 18 号 (215100)  
Add: No. 18, Youxiang Road, Suzhou, Jiangsu  
电话 /Tel: 0512-65856186  
传真 /Fax: 0512-65856186  
网址 /Web: https://www.ecovacs.cn

科沃斯机器人作为全球最早的服务机器人研发与生产商之一, 专注于服务机器人的独立研发、设计、制造和销售。

从创立伊始的二十五年间, 已成功推出包括扫地机器人地宝, 擦窗机器人窗宝, 空气净化机器人沁宝和管家机器人 UNIBOT 的完整家用机器人产品线, 以及以公共服务机器人汪宝为主的商用机器人系列产品。科沃斯机器人二十余年在服务机器人市场的耕耘, 赢得了用户的一致肯定。

ECOVACS Robotics was one of the first companies in the world to develop and manufacture service robots, and today specializes in the independent R&D, design, manufacture, and sale of its own robotic product range.

In the 25 years since its inception, we have successfully launched a comprehensive range of domestic service robots, such as the DEEBOT floor cleaner, WINBOT window cleaner, and AIRBOT air purifier and housekeeper, alongside a series of robots for commercial use led by the BENEBO public service robot. All of the hard work and dedication put in by ECOVACS over the past two decades has earned consistent praise from customers.

#### 主要展品 /Products

地宝: X1 家族、T20 家族  
窗宝: W1 PRO、W1、W920  
沁宝: Z1、ANDY PRO  
DEEBOT: X1 family、T20 family  
WINBOT: W1 PRO、W1、W920  
AIRBOT: Z1、ANDY PRO



科尤特软件(上海)有限公司  
Qt Group

W4-4B40

地址: 上海市徐汇区虹桥路 3 号港汇恒隆二座 3306-3307 室 (200052)  
Add: Room 3306-3307, Block 2, 3 Hong Qiao Road, Xuhui District, Shanghai  
电话 /Tel: 021-51748525  
传真 /Fax: 021-51748526  
网址 /Web: www.qt.io

Qt Group 是一家跨国软件公司, 深受各行业领导者和全球 150 多万开发者的信赖, 助力打造用户喜爱的应用程序和智能设备。我们帮助客户在整个产品开发生命周期中提高生产力——从 UI 设计、软件开发到质量管理和部署。我们的客户遍布 180 多个国家和地区, 涉及 70 多个行业。Qt Group 拥有近 700 位员工, 2022 年的净销售额为 1.55 亿欧元。更多信息, 请访问 <https://www.qt.io/>。

Qt Group (Nasdaq Helsinki: QTCOM) is a global software company, trusted by industry leaders and over 1.5 million developers worldwide to create applications and smart devices that users love. We help our customers to increase productivity through the entire product development lifecycle: from UI design and software development to quality management and deployment. Our customers are in more than 70 different industries in over 180 countries. Qt Group employs some 700 people, and its net sales in 2022 were 155.3 MEUR. To learn more, visit <https://www.qt.io/>.

#### 主要展品 /Products

Qt 6 是面向未来的生产力平台

下一代的用户体验: 使用设计师和开发者易用的工具、更精简但强大的 QML 语言以及灵活的图形架构, 打造定制化的或原生风格的 2D 和 3D 应用, 实现品牌一贯体验。

无限的可扩展性: 从微控制器 (MCU) 到超级计算机, Qt 6 系列和 Qt 庞大的生态系统提供了整个产品线的设计、开发和部署所需的一切。一套代码适用于各种硬件、操作系统或裸机, 创建前端美观、后端强大的应用程序。

Qt 6 is the productivity platform for the future. Software requirements are increasing exponentially, your team's capacity is not! Qt 6's tools & APIs empower designers and developers to create more!

Next-Generation User Experience: Build consistently branded 2D & 3D applications with a custom or native look & feel – using designer and developer-friendly tools, a leaner, yet more powerful QML language, and a flexible graphics architecture.

Limitless Scalability: From microcontrollers (MCUs) to supercomputers, Qt 6 and our massive ecosystem provides everything you need to design, develop, and deploy software for your entire product line. Create applications that are beautiful in the front-end and powerful in the back-end, with the same codebase for any hardware, any OS, or on bare metal.



**库贝化学(上海)有限公司**  
**Kuberd Chemicals (Shanghai) Co.,Ltd**

**W4-4B22**

地址: 上海市金山区秋实路 688 号 (201512)  
Add: No. 688, Qiushi Road, Jinshan District, Shanghai  
电话 /Tel: 021-58531118  
传真 /Fax: 021-33835993  
网址 /Web: www.kuberd.com

库贝化学位于上海市金山化工第二工业园区。是中国一家全方位、系统研发、生产多样固化方式聚硅氮烷的本土企业,是继 Merck 之后的专业特种树脂生产厂家。业务涵盖多样化、高性能、绿色、功能性高端树脂,产品广泛应用于电子、电器、航天、船舶工业、建筑、轨道交通等领域。公司与中科院、军工科研单位航天研究所等保持长期深入的项目合作,并聘请业内资深专家做顾问,具有雄厚的技术储备和强劲的研发及成果转化能力。

Kuberd Chemical (Shanghai) Co.,LTD is located in Shanghai Jinshan Chemical industrial park's second zone. The company is an all-round, systematic R & D, production of polysilazane curing mode of the local enterprises, following Merck is a professional special resin manufacturers. Business covers diversification, high-performance, green, functional high-end Resin, products are widely used in electronics, electrical, aerospace, shipbuilding, construction, rail transportation, etc. The company maintains long-term and in-depth cooperation with the Chinese Academy of Sciences and the Aerospace Research Institute, and employs senior experts in the industry as consultants, with Strong Technical Reserves and strong R & D and achievement transformation capabilities.

**主要展品 /Products**

聚硅氮烷树脂  
Polysilazane resin



**昆山荣逸自动化设备有限公司**

**W1-1B12**

地址: 昆山市 (215300)  
电话 /Tel: 18962678018

昆山荣逸自动化设备有限公司成立于 2010 年,是一家专注于锁螺丝供料设备集成提供整体解决方案的研发生产厂家。公司创始人徐振凯,出生于台湾省高雄市。1995 参与了日本企业品牌螺丝供料设备的技术研发团队,根据客户市场的需求将螺丝供料系统做得极致,不断研发创新。

**主要展品 /Products**

螺丝送钉机,振动盘,补料仓,螺母点数机,自动锁螺钉机



**昆山泰瑞克智能科技有限公司**  
**Kunshan Tyrek Intelligent Technology Co.,Ltd**

**E1-1B22**

地址: 江苏省昆山市开发区朝阳东路 99 号  
电话 /Tel: 0512-57801392  
网址 /Web: www.tyrek.cn

公司以智能家电为主导方向,从事智能家电核心部件的研发与制造。

泰瑞克坚持在产品研发上大力投入,并取得优异成绩,获得国家 30 项专利,于 2017 年被政府评定为“昆山市研发科技中心”,并入选“昆山创业计划”,2019 年被评为“江苏省民营科技型企业”,2020 年评定为“高新技术企业”,符合国家安全生产标准化企业。产品通过欧盟 CE 认证、FCC 认证, RoSH 认证,严格执行 ISO9001 质量管理体系运行。

**主要展品 /Products**

主营: 电解水杀菌模块、即热加热器组件、无线天线等;为客户提供项目研发、软件开发等技术支持。



**昆山王子过滤制品有限公司**  
**KunShan Oji Filter Co., Ltd**

**W5-5A04**

地址: 江苏昆山市陆家镇丰夏路 28 号 (215331)  
Add: 215331 No.28 Fengxia Road,Lujia Town,Kunshan,Jiangsu Province,China  
电话 /Tel: 86-0512-57879118  
传真 /Fax: 86-0512-57879288  
网址 /Web: www.ojiholdings.cn

昆山王子过滤的商业领域是 [ 环境 ]。通过以确保高层大厦以及住宅空气质量 IAQ(Indoor Air Quality) 领域和节能领域共存为指向的事业,并以 [ 以节能来善待地球 ] 和 [ 为现在的人以及未来的孩子们减轻空气污染 ] 为使命,规划实现 [ 超越领域,领驭未来 ] 的蓝图

**主要展品 /Products**

全热交换芯体 / 除臭过滤网  
TOTAL HEAT EXCHANG / CD FILTER



**怡口净水**  
**昆山怡口净水系统有限公司**

**W3-3F01**

地址: 江苏省昆山市玉山镇玉杨路 366 号  
电话 /Tel: 051250367200

怡口净水隶属于美联集团,是伯克希尔·哈撒韦公司下属企业。

通过其先进的专有软化和净化技术,怡口净水改善了万千家庭的生活品质。

凭借无与伦比的经销商业模式和覆盖全国的销售及服务网络,我们用定制解决方案和服务不断超越客户的期望。



主要展品 / Products

怡口商用净水为企事业单位提供专业直饮水解决方案

**LEXY 莱克**

让世界更干净

**莱克电气股份有限公司**

地址：江苏省苏州新区向阳路1号 (215009)

电话 /Tel: 400-8288-088

传真 /Fax: 0512-68258388

网址 /Web: <https://www.lexy.cn/lexy>

**E2-2E41**

莱克电气股份有限公司 (前身是苏州金莱克电器有限公司, 成立于1994年), 总部位于苏州新区向阳路1号。是一家以高速整流子电机为核心技术, 以吸尘器、空气净化器、智能净水机、厨房电器等绿色小家电产品和园林工具产品为主营业务, 以自主品牌和 ODM 为经营模式的家电企业。注册资本 40100 万元人民币。2015 年 5 月, 公司在上海证券交易所成功上市。

Kingclean Electric Co., Ltd. formerly named Suzhou Jinlaike Electric Company Ltd., set up in 1994, locates its headquarter at No. 1 Xiangyang Road, Suzhou New District. Kingclean, an electric household company with high speed universal motor as its core technology, owns its own Brand and also operates ODM business including home appliance like vacuum cleaner, air cleaner, intelligent water purifier, kitchen appliance and garden tools. The registered capital is RMB401 Million. The company was successfully listed at Shanghai Stock Exchange in May, 2015.

主要展品 / Products

公司拥有 LEXY 莱克、bewinch 碧云泉、Jimmy 吉米、Lexcook 莱小厨、SieMatic 西曼蒂克等自主品牌, 其中莱克品牌定位于环境清洁和健康小家电领域的高端民族品牌, 主要产品包括立式多功能无线吸尘器、大洁净空气量甲醛专用净化器、水离子涡扇电吹风和智能空气调节扇等产品。

The company has independent brands such as LEXY, bewinch, Jimmy, Lexcook and SieMatic. Among them, LEXY brand is positioned as a high-end national brand in the field of environmental cleaning and healthy small household appliances. Its main products include vertical multi-functional wireless vacuum cleaner, special formaldehyde purifier with large clean air volume, water ion vortex hair dryer and Intelligent electric fan.



**莱梅娜 (上海) 建材有限公司**

地址：上海市徐汇区文定路 200 号 laminam 展厅

电话 /Tel: 52988283

网址 /Web: [www.laminamcn.com](http://www.laminamcn.com)

**N2-2C81**

Laminam 公司成立于 2001 年, 是因为陶瓷行业的创新者 Franco Stefani 想要打破格局, 直至最终将陶瓷薄板这一产品及产品的制造付诸于实践。在创想到研发的过程中, 我们申请所有生产超大型超薄陶瓷薄板生产及研发专利以保护我们知识产权。二十一世纪初, 我们将产品和技术注入市场。现在, 我们仍持续寻找产品更新颖, 更有创造力的用途, 以充分发挥它的潜力。

主要展品 / Products

进口岩板



**兰溪市越强电器有限公司**

**LANXI YUEQIANG ELECTRICAL APPLIANCES CO., LTD**

地址：浙江兰溪经济开发区建兰路 5 号 (321102)

电话 /Tel: 0579-89019800

传真 /Fax: 0579-88813872

网址 /Web: [www.yueqiang.net.cn](http://www.yueqiang.net.cn)

**W2-2A33 2A34 2A35**

兰溪市越强电器有限公司, 是一家集研发、生产、销售于一体的国家高新技术企业。公司致力于压缩机用起动机、保护器研发与生产, 目前产品已匹配国内外各大压缩机公司, 用于各大终端知名品牌产品, 得到行业内和市场上的一致认可。我公司秉承“人无我有 人有我廉 顾客至上 诚信守约”的企业精神, 一如即往的在产品质量和服务上追求卓越, 与用户真诚合作, 共创辉煌!

主要展品 / Products

压缩机用起动机: 产品适用于电冰箱、冷藏柜、制冰机和类似用途的商业制冷器具的压缩机启动, 产品具有安全式 PTC 结构, 优良的安全性。该产品衍生出各类款式和型号, 能满足市场和客户的需求。压缩机用保护器: 产品适用于电冰箱、冷藏柜、制冰机和类似用途的商业制冷器具的压缩机过热、过载保护, 性能稳定, 体积小, 利于安装。产品已覆盖市面上大多数压缩机使用参数需求, 能够在各类使用场景中有效的保护压缩机。



**廊坊瑞地新材料科技有限公司**

**Langfang Ruidi New Material Technology Co., Ltd.**

地址：河北·文安经济开发区丰利北路

Add: Wen An County Economic Development Zone Hebei Province of China

电话 /Tel: 0316-5232139

传真 /Fax: 0316-5231163

网址 /Web: [www.fulixiangsu.com](http://www.fulixiangsu.com)

**W3-3B25**

廊坊瑞地新材料科技有限公司, 原文安县福利工业公司, 成立于 1987 年, 公司致力于空调制冷行业, 防水行业、汽车行业、机械行业等减震耐磨密封橡胶零部件生产, 公司销售网络遍布全国 30 个省, 公司与奥克斯空调, TCL, 海信, 韩国 LG 电子、富士康、华为等众多知名企业建立长期稳定的业务关系, 公司为客户提供一流销售服务, 可根据客户需求开模设计加工订做, 公司致力于打造一家一流的生态型橡胶制品平台。

Langfang Ruidi New Material Technology Co., Ltd., Wenan fulli industry company, was founded in 1987, the company is committed to air conditioning refrigeration industry, waterproofing industry, automobile industry, machinery industry and so on shock resistant seal rubber parts production, the company sales network all over the country 30 provinces, the company with the AUX air-conditioning, Korea LG, foxconn, huawei, and many other well-known enterprises to establish long-term stable business relations, the company to provide clients with first-class sales and service, can open mold design and processing customized according to customer demand, to provide customers with a complete set of solutions at the same time, the company is committed to making a first-class ecotype rubber product platform.



**主要展品 /Products**

橡胶配重块 / 防震胶 / 橡胶固定块, 使用范围: 空调, 热泵空气能热水器, 除湿机制冰机。使用部位: 空调压缩机连接铜管减震。

使用方法: 护管胶块作用为防止配管之间碰撞, 由于护管胶块本体偏心, 要确保装配时位置准确, 通常为达到护管胶块位置不变, 要用相应束紧带扎紧。

weight rubber/butyl damper /Rubber fixed block, Use scope: air conditioning, heat pump water heater, air dehumidifier ice machine.

Use parts: connection copper tube shock absorption air conditioning compressor.

Method of use: protecting tube glue block act.

**LECI****乐磁电子有限公司****W3-3B32**

地址: 乐清湾湾区乐商创业园创新路 6 号 (325608)

电话 /Tel: 13757796360

传真 /Fax: 0577-61300588

网址 /Web: www.leci.cn

本公司专业生产开关插座 20 年, 与各大品牌皆有合作, 精益求精做出更好的产品!

**主要展品 /Products**

船型翘板开关、AC 插座 (八字插座, 梅花插座, 品字插座)、储能插座 (欧规, 美规, 法规, 英规, 瑞士等等), 微动开关, 按钮开关, 电源插座

**JX SJ****乐清市嘉信科技有限公司****YueQing Jiaxin Technology Co., Ltd.****W3-3H74**

地址: 浙江省乐清市蒲岐特色工业园区 (325609)

电话 /Tel: 0577-62211728

传真 /Fax: 0577-62217728

网址 /Web: Http://www.jiaxinele.com

本公司拥有着雄厚的技术开发能力及引进国际先进的生产设备, 拥有一批专门从事产品开发研制的工程人员和精工制作的生产队伍, 产品广泛应用于影像, 音响, 通讯, 电脑, 家用电器及其它电子设备。嘉信公司以其品质优良而畅销国内外, 深受用户好评, 享有很高的声誉。

**主要展品 /Products**

电源插座, 电源开关, 船型开关

**乐清市晶瀚电子有限公司****YUEQING JINGHAN ELECTRONIC CO., LTD****N2-2B31**

地址: 浙江省乐清市蒲岐镇特色工业园区 (325608)

Add: PuQi characteristic industrial district, Yueqing City, Zhejiang

电话 /Tel: 0577-62308875

传真 /Fax: 0577-62308861

网址 /Web: www.jinghanele.com

专业自主开发、设计、生产各种船型 (器具) 开关、微动开关、门控开关、按钮开关及过载保护开关等。应用于电子仪器仪表、机床自动控制器、电动、园林工具、喷涂设备、汽车、家用电器、小家电等。产品已获得 UL、CUL、TUV、SAA、KC、CQC、CCC、CE、CB、ROHS、PAHS 等多项权威认证, 并获得国家多项专利。精心生产、精细品质是晶瀚电子的宗旨及理念! 欢迎新老客户洽谈合作!

**主要展品 /Products**

生产各种船型 (器具) 开关、微动开关、门控开关、按钮开关及过载保护开关等

**乐清市厦华电子有限公司****W2-2B45**

地址: 浙江省乐清市虹桥镇幸福东路 1028-1036 号 (325600)

电话 /Tel: 15067878888

传真 /Fax: 0577-62252367

网址 /Web: www.xiahuae.com

乐清市厦华电子有限公司是一家专业生产温控器、跷板开关、旋转开关及 AC 插座等系列产品的企业。

产品主要用于电火锅、电火锅、煎烤锅、电饭煲、电烤箱、空炸锅、自动控制器、电子仪表、医疗器械及通讯设备等领域。

公司通过 ISO9001 质量管理体系认证, CQC 认证, CCC 认证, UL 认证, TUV 认证, CE 认证, CB 认证。

**主要展品 /Products**

可调温控、跷板开关、旋转开关、器具插座



**乐清市心牌电子科技有限公司**  
**Yueqing city heart technology Co., Ltd.**

**W3-3B27**

地址: 乐清市经济开发区纬 17 路 271 号 (325600)

电话 /Tel: 86-0577-62905968

传真 /Fax: 86-0577-62905978

网址 /Web: www.singpai.cn

乐清市心牌电子科技有限公司, 是一家集研发、制造、市场营销为一体的民营电子科技企业。是专业致力于臭氧发生器、水处理系统、健康电器等环保领域的研发、制造、销售和服务为一体的高新技术企业。公司一直以臭氧技术为导向, 是目前国内臭氧行业颇具实力的科技型企业。

**主要展品 /Products**

臭氧发生器模块, 耐臭氧硅胶管



**冷镜科技(深圳)有限公司**

**N1-1A23**

地址: 深圳市龙岗区华南皮革城

电话 /Tel: 18656350616

本公司致力研发智能卫浴镜产品, 开发电子智能的智能成像镜。

**主要展品 /Products**

冷镜智能卫浴镜柜



**立奇(南京)电子科技有限公司**  
**Liqi (Nanjing) Electronic Technology Co., LTD**

**E3-3B33 3B34**

地址: 中华人民共和国江苏省南京市浦口区中创新广场 5 栋 19 层 (210000)

Add: 19th Floor, Building 5, Zhongke Innovation Plaza, Pukou, Nanjing, Jiangsu, China

电话 /Tel: 025-86806566

传真 /Fax: 025-86806566

网址 /Web: www.linky-tech.com

LINKY 立奇电子, 隶属于恒顺兴实业集团, 专注于创新落地, 为中国创造而生。

研发团队覆盖工业设计、电子技术、软件开发、结构设计、工程工艺、模具设计等实业制造相关的各个环节。

创新工厂模具车间拥有各进口高精度 CNC 数控机床、EDM 火花机、3 坐标等加工设备, 为您的创新实现提供精度的保障。

电子车间为无尘车间, 覆盖开发、生产、测试环节, 自动 SMT 产线可保障充足的产能。

LINKY Electronics, affiliated to Hengshunxing Industrial Group, focuses on innovation landing, created for China.

The r&d team covers industrial design, electronic technology, software development, structural

design, engineering process, mold design and other industrial manufacturing related links.

Innovation factory mold workshop has imported high-precision CNC machine tools, EDM spark machine, 3 coordinates and other processing equipment, for your innovation to provide precision guarantee.

The electronic workshop is dust-free workshop, covering development, production and testing.

The automatic SMT production line can guarantee sufficient capacity.

The injection molding workshop has 110 injection molding machines of all tonnage, all equipped with automatic arms, including dual-color injection molding, compact injection molding and other processes.

**主要展品 /Products**

LINKY 多功能洗头机

LINKY Multi-purpose shampoo machine

## LIEBHERR

**利勃海尔(中国)有限公司**  
**Liebherr (China) Co., Ltd.**

**N4-4F81**

地址: 上海市浦东新区高设北路 319 号 (201208)

Add: No. 319 North Gaoshe Road, Pudong New District, Shanghai, China

电话 /Tel: 400 820 3811

网址 /Web: home.liebherr.com

**利勃海尔中国**

1978 年在北京设立了第一个办事处。此后利勃海尔集团一直在坚定地拓展销售、服务和制造业务。目前, 利勃海尔集团在中国市场提供多元化的产品及服务, 在中国所销售的产品几乎涵盖了所有产业, 包括工程机械和矿用设备、海上起重机、航空和运输系统、零部件、齿轮加工技术及自动化和家用电器等。我们将带您一同领略利勃海尔设备及零部件的尖端技术及其强大的实用性。

**Liebherr China**

The first office was established in Beijing in 1978. Since then, the Liebherr Group has been firmly expanding its sales, service and manufacturing activities. At present, Liebherr Group provides a wide range of products and services in the Chinese market. The products sold in China cover almost all industries, including construction machinery and mining equipment, offshore cranes, aviation and transportation systems, components, and gear processing. Technology and automation and household appliances, etc. We will take you through the cutting-edge technology and powerful practicality of Liebherr equipment and components.

**主要展品 /Products**

独立式冷藏冰箱、独立式冷冻冰箱、独立式冷藏冷冻组合冰箱、嵌入式冷藏冰箱、嵌入式冷冻冰箱、嵌入式冷藏冷冻组合冰箱、独立式酒柜、嵌入式酒柜、雪茄柜

Freestanding fridge, freestanding freezer, freestanding fridge and freezer, fully integrated fridge, fully integrated freezer, fully integrated fridge and freezer, freestanding wine cabinets, fully integrated wine cabinets, humidor



**溧阳康达威实业有限公司**

**Liyang kangdawei industrial Co.,Ltd**

地址: 江苏省溧阳市天目湖工业区云眉路 8 号 (213300)

电话 /Tel: 0519-87985926

传真 /Fax: 0519-80699962

网址 /Web: www.chinakdw.com

**N2-2B20**

溧阳康达威实业有限公司成立于 1997 年, 是江苏省高新技术企业, 也是南京大学化工学院成果转化基地, 公司一直致力于有机硅胶粘剂、偶联剂的研发生产和销售, 主要产品有: 有机硅粘接密封胶, 有机硅灌封胶, 三防胶以及导热系列产品, 公司提供高性能产品, 产品服务国内外知名家电企业: 松下、西门子、A.O 史密斯、格力、美的、海尔等家电客户, 客户的满意是我们最大的追求, 欢迎来电咨询。

**主要展品 /Products**

有机硅粘接密封胶, 有机硅灌封胶, 三防胶以及导热系列产品



**六安索伊电器制造有限公司**

**Lu'an Soyea Electric Manufacturing Co., Ltd.**

地址: 安徽省六安市经济技术开发区皋城东路 (237000)

Add: East Gaocheng Road, Economic & Technological Development Zone, Lu'an City,

Anhui Province, China

电话 /Tel: 0564-3380903

传真 /Fax: 0564-3380997

网址 /Web: www.china-soyea.com

**W4-4F61**

索伊集团是享誉国际的专业化家电制造商, 拥有上海和六安两大生产基地。

索伊集团涉及电器产品制造、云餐物联、智能保鲜、绿华科技、智慧云营、酒店餐饮及矿山开采七大数据, 多元化产业发展的模式已然成型。2012 年以后, 确定以“智慧餐厨项目工程”为核心的发展方向, 形成以“智能化数字厨电产品”研发、制造和应用为核心的智能化数字化产业集群, “智慧餐厨项目工程”列入安徽省“十四五”期间智能家电产业重大项目。

Soyea Group is a world-renowned professional household appliance manufacturer with two production bases in Shanghai and Lu 'an.

Soyea Group is involved in seven major sectors: electrical product manufacturing, cloud food and things, intelligent preservation, Luhua Technology, intelligent cloud business, hotel and catering and mining, and the diversified industry development model has taken shape. After 2012, to determine the "smart kitchen project engineering" as the core of the development direction, the formation of "intelligent digital kitchen products" R&D, manufacturing and application as the core of the intelligent digital industrial cluster, "smart kitchen project engineering" is listed in Anhui province during the "14th five-year" intelligent home appliance industry major projects.

**主要展品 /Products**

智能化数字烹饪机器人

智能化数字机器人饮料机

智能化数字营养冲调机

智能化数字无人售卖机

智能化数字商用冷链

智能化数字冰冷保鲜柜

AI digital cooking robot

Intelligent digital robot beverage machine

AI digital nutrition punching and adjusting machine

AI digital unmanned vending machine

AI digital commercial cold chain

AI digital fresh-keeping cabinet



**鲁班到家**

**LBDJ**

**N1-1B36**

地址: 深圳市宝安区西乡街道劳动社区西乡大道和宝源路交汇处中央大道 D 座 5A、

中央大道 D 座 5F (518100)

Add: 5A, Block D, Central Avenue, intersection of Xixiang Avenue and Baoyuan Road, Labor community, Xixiang Street, Bao 'an district, Shenzhen

电话 /Tel: 0755-23326370

传真 /Fax: 0755-23326370

网址 /Web: www.lbdj.com

鲁班到家成立于 2015 年 7 月, 隶属于萨科 (深圳) 科技有限公司, 在千亿家装后市场的机遇与挑战下, 为解决家居建材行业痛点, 满足商家与用户需求, 倾力打造的“互联网+配送、安装、维修”的共享经济服务交易平台, 为全国用户提供智能家居、家具、卫浴、灯具等全品类家居建材产品售后的同城配送、安装、维修等最后一公里服务! 从根本上解决家居建材售后线条长、品控难、无保障、价格乱的紧迫难题。

LBDJ was founded in July 2015, under Sacco (Shenzhen) Technology Co., Ltd. . Under the opportunities and challenges of the 100 billion home decoration aftermarket, in order to solve the pain point of the home building materials industry, to meet the needs of businesses and users, the "Internet + distribution, installation and maintenance" sharing economic services trading platform, for the national users to provide intelligent home, furniture, sanitary ware, lamps and other full range of home building materials products after the city distribution, installation, maintenance and other one-kilometer service! Fundamentally solve the home building materials after-sales line long, quality control difficult, no security, price chaos of the urgent problem

**主要展品 /Products**

家电、家居售后安装服务

Home appliances, home after-sales installation services



### 玛堡工业元件 (上海) 有限公司

N4-4A35

地址: 上海市闵行区七莘路 1809 号红点城 2501 室 (201101)

电话 /Tel: 021-64061831

传真 /Fax: 021-64061833

网址 /Web: www.mar-bal.com.cn

玛堡工业元件 (上海) 有限公司成立于 2012 年 1 月, 是美国玛堡工业集团在中国的全资子公司, 负责美国玛堡工业集团在亚太区的所有销售业务、技术支持和客户服务。公司目前主要经营美国玛堡工业集团的复合支柱绝缘子相关业务。玛堡产品各类资质认证齐全。比如, 早在 1982 年, 玛堡公司就获得了双 UL 认证: 针对玛堡绝缘材料的 UL 认证和针对玛堡绝缘子的 UL 认证, 同时还有其他一些认证如 RoHS, REACH, CE 等。

#### 主要展品 /Products

BMC 绝缘子, BMC 材料定制件



### 美而浦

#### MULTIPURE

N3-3E61

地址: 广东省广州市番禺区南村镇捷顺路 9 号敏捷上城国际 6 栋 01 (511400)

电话 /Tel: 020-39959898

传真 /Fax: 020-39959898-6009

网址 /Web: http://www.reehmultipure.com/

MULTIPURE 美而浦, 1970 年创立于美国, 领行业之先, 研发、制造出高压烧结活性炭滤芯, 开创直饮矿泉水净水器时代。整机美国原装进口, 畅销全球 80 多个国家和地区。50 年专注净滤科技, 荣获 NSF 等全球 11 大权威机构认证, 高效去除 100 多种污染物, 滤除率高达 99.99%, 同时保留有益矿物质, 净化后水质媲美天然矿泉水。

#### 主要展品 /Products

净水器



### 美国国际铜专业协会上海代表处 International Copper Association

W1-1C81

地址: 上海市黄浦区淮海中路 381 号 25 楼 35-36 室 (201103)

Add: Room 23, 26F, No.222 Huaihaizhong road, Huangpu district, Shanghai

电话 /Tel: 021-63915816

传真 /Fax: 021-63916331

网址 /Web: https://copperalliance.org/

作为一家非营利性国际组织, 国际铜业协会成立于 1959 年, 总部位于美国华盛顿。目前拥有 39 家会员, 包括覆盖世界精铜产量 60% 的铜矿企业、冶炼厂以及全球领先的铜及铜合金加工企业。国际铜业协会于 1995 年进入中国, 并在北京和上海设立办事机构。在过去的 20 多年里, 国际铜业协会联合全球铜工业, 致力于研究并推广铜的社会价值和有效使用, 使其为国家经济及行业的绿色发展和提高人类生活品质作出贡献。

As a not-for-profit trade association, The International Copper Association, Ltd., (ICA) leads the world's copper industry on the issues critical to securing copper's future growth and achieving sustainable development goals. ICA is committed to supporting policy development and implementation, advocating industry and technology innovation and promoting environmental-friendly consumption awareness.

The International Copper Association, Ltd. (ICA), its 36 members and the alliance of national and regional associations are responsible for program development and implementation with ICA's more than 500 current program partners around the world.

The Copper Alliance® represents a network of regional copper centers and their industry-leading members, led by ICA. Headquartered in Washington, D.C. Copper Alliance programs and initiatives are executed in nearly 60 countries through its regional offices and a broad network of copper promotion centers.

#### 主要展品 /Products

铜佳品质生活项目一直坚持通过在家电产业链领域宣传铜产品优势, 并和终端产品结合贴标明示用铜部件的推广方式, 捍卫用铜市场, 并和国内众多知名头部品牌一起共同提升整体品牌的知名度和扩展市场覆盖的广度, 为消费者提供科学认知理性选择的美好生活方式。

Through "Copper Inside," ICA is committed to promoting the adoption of copper components within the home appliance industry and highlighting the value copper represents to consumers. As more leading brands join hands with ICA, "Copper Inside" is well positioned for a continued rise in visibility and market coverage.



### 美康雅国际贸易有限公司

E3-3C01

#### Conair International Trading Limited

地址: 深圳市福田区农林路鑫竹苑大厦 A 座 201, 202, 205 (518000)

Add: Room 201-202, Building A, Xin Zhu Yuan, Nonglin Road, Fu Tian District, Shenzhen, China

电话 /Tel: 075583022778

传真 /Fax: 075583022778

网址 /Web: www.babyliss.cn

CONAIR 集团成立于 1959 年, 是世界上最大、最多元化的消费品公司之一。美国最大个人护理小家品牌, 全球个人护理行业的领导者, 旗下拥有 24 个品牌: Conair, 沙宣 VS, Babyliss, Cuisinart 等。制造和分销个人护理、保健、美容产品以及高级厨房电器和厨具。以创新的先进技术, 不断研发创意领先的优质产品, 和消费者一起体验专业而便捷的灵感生活。

Conair and its brands are names known throughout the world. As a leading manufacturer and marketer of professional and consumer products, Conair continues to introduce its brands to new and emerging markets. With the Company increasing its global presence every year, To continue our focus on innovation and advanced technology to develop new products that improve the everyday lives and businesses of our consumer and professional customers all over the world.





#### 主要展品 /Products

主要从事个人护理,美容美发产品,专业的沙龙美发工具等,包含:直卷发棒,吹风机,造型梳,理发器,发梳等。

Personal care, beauty products, professional hair salon tools, including: hair styler, hair dryers, styling combs, hot air styler, combs, etc.

**Cuisinart**  
SAVOR THE GOOD LIFE

美康雅国际贸易有限公司

N3-3F71

Conair International Trading Limited

地址:深圳市福田区农林路鹏城建筑集团鑫竹苑大厦 A 座 201、202、205 (518000)

Add: Room 201, 202, 205, Building A, Xinzhuoyuan Building, Pengcheng Construction Group,  
Nonglin Road, Futian District, Shenzhen

电话 /Tel: 075583022778

传真 /Fax: 075583022778

网址 /Web: <http://www.cuisinartchina.com/>

CONAIR 集团是全球个人护理电器品牌和厨房品牌行业的领导者,成立于 1959 年,旗下品牌覆盖个人护理、专业美发以及高端厨房电器、厨具等众多领域,年销售额超过 35 亿美元。

Cuisinart 美膳雅,作为集团旗下高端厨电品牌,创立于 1971 年。创始人 Carl Sontheimer 先生将 Cuisine 烹饪与 Art 艺术融合于品牌 DNA,旨于为全球消费者提供专业厨房电器与厨具产品,共创高品质、美好生活。

Founded in 1959, CONAIR Group is a global leader in personal care appliances and kitchen brands, with annual sales of more than \$3.5 billion across a wide range of brands, including personal care, professional hair, high-end kitchen appliances and kitchenware, etc.

Cuisinart, as a high-end kitchen appliance brand under the Group, was founded in 1971 after Carl Sontheimer, founder of Cuisinart, fell in love with the unique French customs and cuisine during a romantic trip to France. Upon that Cuisinart, a brand combining Cuisine and Art in DNA, was born. Now, Cuisinart is firmly a leader in kitchen appliances and kitchenware in North America, with annual sales of more than \$1.5 billion. With 50 years of heritage combined with innovative technology, Cuisinart focuses on providing diversified kitchen solutions for consumers around the world, bringing a high-quality, healthy and good life.

#### 主要展品 /Products

主营厨房小家电以及厨具产品,包括电蒸锅、热风炉空炸烤箱、食物处理器、咖啡机、多功能料理锅、华夫饼机、冰激凌机、手持料理棒、户外烧烤炉、锅具、刀具、厨房用具等。

Small kitchen appliances and kitchenware products, including steamer, air fryer oven, food processor, coffee maker, multifunctional cooking pot, waffle maker, ice cream maker, hand blender, outdoor grills, cookware, cutlery, gadgets and tools, etc.



德国·美乐家™咖啡

美乐家咖啡(上海)有限公司

N4-4B33 4B34

Melitta Coffee (Shanghai) Ltd.

地址:中国上海市静安区威海路 696 号 02-220 室 (200041)

电话 /Tel: 68827522

传真 /Fax: 68827517

网址 /Web: [www.melitta.cn](http://www.melitta.cn)

1908 年, Melitta Bentz 女士发明了手冲滤杯滤纸。同年,成立了 Melitta。创立以来秉承“让人们能更好地享用咖啡”使用,不断超越创造经典,将其对咖啡的理解与追求通过每一件产品来诠释,一直致力于提供行业内各项咖啡服务。从大型商用全自动咖啡机,至家用全自动、滴滤式咖啡机。从咖啡滤杯滤纸,到多品种的优质烘焙咖啡粉及咖啡豆,高品质的服务及产品让人们更懂咖啡,尽享咖啡的醇正与乐趣。

#### 主要展品 /Products

家用全自动、滴滤式咖啡机、手冲咖啡滤杯滤纸以及配套咖啡类产品。

Miele

美诺电器有限公司

N4-4F61 4F71

地址:上海市天目西路 128 号嘉里企业中心 1 座 25 楼 (200000)

电话 /Tel: 021-61573500

传真 /Fax: 021-61573511

网址 /Web: [www.miele.cn](http://www.miele.cn)

德国美诺 Miele 自 1899 年创立至今,始终坚持“Immer Besser 不断超越”的品牌精神,致力于提供贴心、舒适的高品质精致生活。产品系列包括厨房电器系列、衣物护理系列及地板护理系列。划时代的革新科技、精湛的德系品质、智能化便捷操作和经典简约的设计风格,为超越时代的品质生活创造无限可能。

#### 主要展品 /Products

厨房电器系列,衣物护理系列,洗碗机系列,地板护理系列,咖啡机系列

**GMCC & Welling**

美芝 & 威灵

W5-5E41

GMCC & Welling

地址:广东省佛山市顺德区大良顺峰山工业区 (528300)

电话 /Tel: 75722809161

传真 /Fax: 75722297514

网址 /Web: [www.gmcc-welling.com](http://www.gmcc-welling.com)

GMCC 美芝 & Welling 威灵 & MR 美仁,作为消费电器核心零部件系统级整体解决方案供应商,坚持绿色创新,持续升级核心科技,为客户提供可靠、绿色、高效、智慧的全品类压缩机、阀、全品类



电机和芯片等产品及解决方案,助力行业健康发展、产业持续升级。产品广泛应用于家用电器、商用制冷制热和移动制冷等领域,如各类空调、冰箱、洗衣机、冷冻冷藏柜、热泵采暖、热泵热水器、冷藏汽车、驻车空调、房车空调等。

GMCC & Welling & MR, as a system-level solution supplier of core components of consumer electronics, adheres to green innovation, continuously upgrades core technology, provides customers with reliable, green, efficient and intelligent products and solutions such as all kinds of compressors, valves, motors and chips, and helps the healthy development of the industry and the continuous upgrading of the industry.

#### 主要展品 / Products

压缩机、电机、芯片、电子膨胀阀等

Compressors, motors, chips, electronic expansion valves



#### 米技电子电器(上海)有限公司

#### Miji Electronics and Appliances (Shanghai) Ltd.

N3-3E41

地址:上海市漕河泾开发区浦江高科技园三鲁路3585号3号楼(201114)  
Add: 3585 Sanlu Rd, B 3 Pujing Industrial Zone 201114 Shanghai, China  
电话 / Tel: 86-021-51692010-0  
传真 / Fax: 86-021-54320239  
网址 / Web: www.miji.com.cn

德国米技是一家集采购,研发,制造及出售高品质厨房用具为一体的公司。目前是按中国优质辐射热炉市场零售销售值计的最大优质辐射热炉制造商及供应商。产品主要为电炉灶。我们的核心品牌为德国米技,米技生活及米技商用。就制造我们的产品,我们有两个生产厂房位于上海及德国。米技源自德国的品牌,进驻中国引入先进科技电灶的先锋企业,引领了厨房科技升级革命。未来将透过提升产品组合、投入更多资源于研究及开发并拓展销售渠道。

Miji International specializes sourcing, developing, manufacturing and selling premium kitchen appliances to middle-class and upper-middle-class customers, its products mainly are Hobs and Stoves (including radiant stoves and induction stoves), core brands are "Miji Design", "Miji Home" and "Miji Pro".

#### 主要展品 / Products

米技远红外辐射热炉;  
米技 IH 高级感应炉;  
整体厨房橱柜及整体规划设计  
厨房小家电  
厨房厨具

Miji Radiant stovens  
Miji Induction stovens  
Kitchen appliance, Kitchenware  
Integral kitchen cabinet



#### 魔芯(湖州)科技有限公司

#### Moxin (Huzhou) Tech. Co., Ltd

W1-1C96 1C97

地址:浙江省湖州市德清县舞阳街道德清地理信息小镇创新园C区13幢(莫干山国家高新区)  
Add: C13, Deqing Geo-Information Town Innovation Park, Huzhou City, Zhejiang Prov., China.  
电话 / Tel: 0572-8219699  
网址 / Web: https://www.kokoni3d.com

魔芯科技于2021年成立,是一家以科技创新为核心驱动,为大众提供无门槛智能创意工具的新兴消费电子产品。目前主营业务为消费级3D打印软硬件产品,具有完善的产研供销体系。在2022年4月发布首款全自研的消费级3D打印机KOKONI EC1,累计销售突破上万台。2023年1月首次参展美国CES展会,并发布新一代全自研产品KOKONI SOTA。截止目前,魔芯科技已完成数千万元Pre-A轮融资。

The Moxin (Huzhou) Technology Co., LTD (KOKONI) is committed to exploring cutting-edge 3D technology, providing software and hardware solutions for creative realization, and creating a one-stop service platform for 3D digital printing. It is a technology-based enterprise focusing on the research, development, production and sales of 3D digital printer products. We are located in Huzhou City, Zhejiang Province. The site uses an area of 2,000 square meters. Now, there are more than 150 employees and with an annual production capacity of 500,000 units.

#### 主要展品 / Products

KOKONI EC1 3D 打印机  
KOKONI SOTA 3D 打印机  
KOKONI 3D App  
KOKONI DIY 工具  
KOKONI EC1 3D Printer  
KOKONI SOTA 3D Printer  
KOKONI 3D App  
KOKONI DIY Tools



#### 南京大佑电子科技有限公司

#### Nanjing Dayoo Electronics Technology Co., Ltd.

E1-1A11

地址:南京市溧水区永阳街道秦淮大道288号  
电话 / Tel: 18795691639  
网址 / Web: www.dayoosmart.com

科技改变生活方式, DAYOO 提升生活品质。

大宇成立于2015年,是一个以通过创新和智能技术改善人们生活质量为使命的跨国团队。我们的目标是让家用电器更智能、更耐用,致力于每个家庭提供更智能的家居解决方案。多年来,我们一直在制造智能家电,包括清洁电器和智能可穿戴设备。

Technology changes the way of life, and DAYOO enhances the quality of life.  
Established in 2015, Dayoo is a multinational team with a mission to improve people's quality of

life through innovative and intelligent technology. We aim to make home appliances smarter and easier to use, dedicating ourselves to providing smarter home solutions for every family. Over the years, we've been manufacturing smart home appliances including cleaning appliances and smart wearables.

#### 主要展品 /Products

大佑便捷高温蒸汽清洁机, 吸尘器集尘盒



#### 南京海川电子有限公司

**NANJING HAICHUAN ELECTRONIC CO.,LTD.**

**N4-4B32**

地址: 南京市六合经济开发区虎跃路 18 号 (211500)

Add: No.18,Huyue Road,Luhe Development,Nanjing,Jiangsu

电话 /Tel: 025-56230008

传真 /Fax: 025-56230009

网址 /Web: www.hcet.cn

南京海川电子有限公司 是一家专业生产温度开关、电机保护器、过流保护器、热保护器、温控器、温度保护器与传感器的国家高新技术企业, 公司通过 ISO/TS16949 质量管理体系认证, 产品通过 UL、TUV、CQC、PSE 国际安规认证; 产品广泛应用于汽车玻璃升降器电机、雨刮电机、充电桩、智能家居、榨汁机、搅拌机、电动工具、电池组、变压器等领域。海川专业的技术致力于提供可靠的过热过流保护综合解决方案。

Nanjing Haichuan electronic co., LTD., specializing in the production of high-end motor protector, over-current protector, thermal protectors, temperature control switch, thermostat, the company passed the ISO/TS16949 quality management system certification, has a number of patents, independent products passed UL, VDE, CQC multinational international safety certification, the products are widely used in glass elevator motor, wiper motor, juicer, mixer, small tubular motor, electric tools, batteries, transformers, etc. HCET with professional technology is committed to providing reliable overheating over-current protection integrated solutions.

#### 主要展品 /Products

温度开关、温控开关、热保护器、过载保护器、过流保护器、电机热保护器、恒温器、温度保护器、温控器、传感器

Temperature switch, temperature control switch, thermal protector, overload protector, overcurrent protector, motor thermal protector, thermostat, temperature protector, temperature controller and sensor



#### 南京三头牛电子科技有限公司 Nanjing SANTNEW Tech Ltd

**W4-4A26 4A27**

地址: 南京浦口城南新村 48 栋 406 (210000)

Add: Room 406 Building 48th chengnanxincun Pukou Nanjing

电话 /Tel: 13802556548

南京三头牛电子科技有限公司 2017 年 5 月成立于南京江北新区, 核心团队主要来自 Mstar、创维、康佳等显示行业头部企业, 公司专注于超短焦光学核心器件的研发和产业化。目前已经研发成功: 超短焦激光光机、超短焦 LED 投影整机、TR1.0 透射比液晶投影镜头、封闭式液晶投影机等产品以及基于华为海思芯片的系列板卡等。公司先后成功入选江苏省双创企业、南京高层次人才企业。

#### 主要展品 /Products

超短焦投影机光学核心器件及整机



#### 南京欣威视通信息科技股份有限公司 Nanjing Signway Technology Co., Ltd.

**W3-3B24**

地址: 江苏省南京市雨花台区软件谷科创城 C3 栋 5 层 (210000)

Add: 5th Floor, C3, Software Valley Science and Technology City, Nanjing, China (Building 3, No. 30 Fengzhan Road, Yuhuatai District)

电话 /Tel: 4008081082

传真 /Fax: 025-83317701

网址 /Web: https://www.njxwst.com

欣威视通 2010 年成立, 专注于商用显示领域整体解决方案, 围绕商显核心, 打造覆盖硬件、软件、平台、AI 的生态产品服务矩阵, 触达智能商显未来。

专注显示智能+, 欣威已深耕商显十余年, 是万众传媒全球数字标牌解决方案设计商; 延伸智能终端领域内涵, 拥有智慧零售、智能楼宇、智慧校园等多种智能解决方案。

从主板设计、终端软件产品到管理平台软件产品, 我们不断为行业用户打造 AIoT 智能终端全栈式解决方案。

#### 主要展品 /Products

从场景出发

欣威视通业务

覆盖硬件 + 软件 + 云平台 + AI 算法

提供客制化 AIoT 智慧终端全栈式整体解决方案

# PANDA

**南京熊猫电子制造有限公司****Nanjing Panda Electronics Manufacturing Co.,Ltd.**

地址: 江苏南京市栖霞区恒通大道1号

电话 /Tel: 025-85757186

**W5-5A12**

南京熊猫电子制造有限公司成立于2004年9月,投资总额3200万美元,其中注册资本2000万美元。公司自1984年创立,经过三十多年不断发展,现有员工2500余人,其中有工程技术人员180余人。公司生产的产品主要产品类型涵盖:通讯类,家电类,汽车电子,商用服务,医疗器械以及根据客户需求提供模块化的方案设计和生产。

Nanjing Panda Electronics Manufacturing Co. Ltd. was established in September 2004 with a total investment of US\$32million, and registered capital of US\$20million. Company was originally built in 1984, with over 30years of development, now with 2500 employees, which include 180 technicians. Main products ranges with communication, home appliances, automobile, commercial service products and medical products.

**主要展品 /Products**

家电类: 模组驱动板, 品牌笔记本主板, 家用电器总成模块; 年生产量3000万套(片)

汽车电子类: 氛围灯, 数码显示屏, 电源模块, 影音模块等。年产量500万套(片)

Home Appliance: T-con board, PC board, HMI module for home appliance, yearly output 30million sets.

Automobile: Lighting of charging, digital display, power module, entertainment module etc, yearly output 5million sets.

**南通恒嘉环保科技有限公司****NANTONG HENKA ENVIRONMENT SOLUTIONS CO.,LTD**

地址: 江苏省南通市海门市滨江街道滨港大道5169号(226113)

Add: No 5169, Bin' gang Ave, Binjiang Subdistrict, Haimen City, Jiangsu Province, China 226113

电话 /Tel: 13813766750

传真 /Fax: 0513-82301900

网址 /Web: www.airfilter-china.com

**E3-3B21**

南通恒嘉环保科技有限公司是一家空气净化领域的高新技术产业公司,成立于2004年,注册资本1631万元整,目前在职工人数150人。公司品牌-恒克斯/Henkaes,公司主要生产空气净化器HEPA滤网、除VOC滤网、除甲醛滤网、除异味活性炭滤网,以及新风系统滤网、光等离子消毒装置、iHepa消毒净化装置和iFD净化装置。产品广泛应用于工业、商业、家用空气净化器,新风系统和公共场合的消毒净化。

Nantong Henka Environment Solutions Co.,Ltd was established on 2004. Henka is air filter manufacturers for air purifier, air cleaner and ventilation system. Our air filter include HEPA air filter, TVOC removing air filter, Formaldehyde removing air filter, Activated Carbon air filter, Odor removing air filter and HVAC air filter. Henka is designated air filter supplier for the most famous brands of air purifier & air cleaner in North America market and China market.

Henka has the advanced test equipment and strict test procedure for raw material, developing and manufacture, guarantee each air filter meet the quality standard, We have the efficiency & air

resistance test system for air filter media and air filter, noise test lab, 30 M3 test room for formaldehyde & VOC removing test, CTC test lab for activated carbon, penetrating life testing for formaldehyde catalyst, CADR test room based on ANSI/AHAM AC-12006. We have the ISO 9001 and ISO 14001 quality system.

**主要展品 /Products**

空气净化器 HEPA 滤网、除 VOC 滤网、除甲醛滤网、除异味活性炭滤网,以及新风系统滤网、光等离子消毒装置、iHepa 消毒净化装置和 iFD 净化装置

HEPA AIR FILTER, CARBON AIR FILTER, VOC AIR FILTER, HVAC AIR FILTER, iHEPA, iFD

**三众科技****内蒙古三众科技有限公司****Inner Mongolia Sanzhong Technology Ltd.****N2-2B36 2B37**

地址: 内蒙古呼和浩特市赛罕区昭乌达路宇泰商务广场C座7层

电话 /Tel: 400-0806886

传真 /Fax: 400-0806886

网址 /Web: http://www.sanzhongkeji.cn/

内蒙古三众科技有限公司创立于2016年,是健康如厕事业的倡导者和先行者,以开创性的“ONMA(昂玛)源头内吸法”,提供具有除臭、杀菌、净化功能的马桶版、蹲坑版、工程版三款卫生间专用空气净化器,马助理系列产品涵盖家庭卫生间、公共卫生间及其他公共卫生间,全面提升健康如厕品质,让卫生间更清新健康,让世界尽享生活之美。三众科技恭迎每位志在投身健康如厕事业的同仁,一同践行“为人类健康如厕而奋斗”的使命!

Inner Mongolia Sanzhong Technology Ltd., founded in 2016, is the advocate and pioneer of healthy toileting. It is committed to bringing the concept of healthy toileting, healthy toileting system and high-quality products to everyone, every family and every region. In this way, we hope to improve toilet health and quality comprehensively, make the toilet air fresher and the environment healthier, and let the world enjoy a better life. With innovation as the soul, R & D as the drive, quality as the guarantee and service as the support, by focusing on the research and development of core technologies such as source deodorization, deep sterilization and multiple purification of toilet, Sanzhong provide a series of assistant Ma products with deodorization, sterilization and purification functions, covering family toilet, public toilet and other public toilet, as well as a set of efficient and practical solutions of toilet problems.

**主要展品 /Products**

马助理就是马桶的助理,简称马助理,装在马桶上,解决卫生间臭味异味、病菌有害菌、隐私尴尬的问题。1. 源头除臭: 瞬间定向净化排便臭气,清新健康。2. 深度杀菌: 杀灭整个卫生间空间内包括洗漱用品上滋生和附着的有害菌。3. 空间净化: 让地漏反味、潮味、霉味通通消失。4. 立体音乐: 保护隐私。5. 智能感应使用方便。6. 手机智控定时净化。7. 夜间免扰安睡无忧。8. 高效节能,人人需要,家家可装,为健康如厕保驾护航。

The main role of assistant Ma:

(1) Source deodorization: Assistant Ma uses the patented technology "ONMA source internal suction method". When going to the toilet, the odor of defecation has been directionally purified immediately before it can run out of the toilet, so it will not leave any odor, and the air is fresh and healthier.



- (2) Deep sterilization: by releasing long-acting ozone group, assistant Ma can kill the harmful bacteria that breed and adhere in the corners and toiletries in the whole toilet space due to humidity and tightness, so as to avoid cross infection.
- (3) Space purification: Assistant Ma's quadruple purification can also make the anti smell, damp smell and musty smell of the floor drain in the bathroom disappear, and the air is fresh all day.
- (4) Stereo music: Protect privacy without embarrassment.
- Everyone needs it and every family can install it to enjoy a healthy toilet.

## NORITZ 能率

专注恒温用热爱家

能率(中国)投资有限公司  
NORITZ (CHINA) CO.,LTD.

N1-1F71

地址: 上海市奉贤区大叶公路 7318 号 (201405)

Add: No.7318 Daye Hwy,Fengxian District,Shanghai,China

电话 /Tel: 021-3718-6666

传真 /Fax: 021-6758-0262

网址 /Web: <https://www.noritz.com.cn>

始于 1951 年, 能率集团以「洗浴令人幸福」为初心, 专注用温水带给人们舒适生活。在日本, 能率热水器年销量位于行业前列, 是先进热水器及温水相关产品的杰出制造商。70 年以来, 能率集团不断为市场供应燃气热水器、采暖炉、净水机、厨房电器等传递生活温暖的设备, 用热爱家, 引领温水生活。除了家用产品外, 能率还提供专业的商用产品, 满足高效、环保、耐用的商用需求。

NORITZ Group is a leading manufacturer of advanced water heaters and hot water products with industry-leading sales volume of water heaters in Japan. Since 1951, the Group has stayed true to its conviction that "bathing makes people happy", focusing on bringing people a comfortable life with warm water. Over the past 70 years, NORITZ Group has continuously launched gas water heaters, heating stoves, water purifiers, kitchen appliances and other equipment, providing our customers with a warm and comfortable home. In addition, NORITZ also provides professional commercial products with high efficiency, environmental protection and durability.

### 主要展品 /Products

能率珞光热水器聚焦时尚高颜值设计, 采用一体成型全面屏幻彩玻璃面板, 尽显家的“优雅与质感”。同时搭载新一代智能控温系统, 面对水压波动, 主动调控水量、燃气比, 将温度起伏控制在  $\pm 0.5^{\circ}\text{C}$ , 告别忽冷忽热。能率珞光热水器采用一键增压, 出水动力大大提升, 达到最高 12m 扬程, 实现长循环零冷水。强劲水流源源不断, 轻松满足大平层、复式、别墅等大房型全屋需求。澎湃舒适恒温水不断按摩身体, 疲惫顷刻间瓦解。

## Nidec

Global-Appliance

尼得科全球电器

Nidec Global Appliance

W1-1E81

地址: 北京天竺空港工业区裕华路 29 号 B 座 101312 (101312)

电话 /Tel: 01080482255

传真 /Fax: 01080482255

网址 /Web: <https://www.embraco.com>

### 关于尼得科全球电器

尼得科全球电器在全球 8 个国家 / 地区, 拥有 14000 多名员工。主要制造和销售各种恩布拉科制冷方案, 以及洗碗机、洗衣机、烘干机用电机。主要通过提供优质、高效、和有竞争力的综合性产品组合, 以满足客户需求。尼得科全球电器事业部是尼得科集团的一部分, 尼得科集团是制造电机和零部件的全球领导者, 总部位于日本。更多信息: [www.nidec.com](http://www.nidec.com)

### About Nidec Global Appliance

With over 15,000 employees across 9 countries, Nidec Global Appliance manufactures and commercializes products for home and commercial applications, including refrigeration solutions, motors for washing machines, dryers and dishwashers, as well as components for heating, ventilation and air-conditioning systems (HVAC).

Its focus is to deliver a complete and innovative portfolio with high standards of quality, reliability, competitiveness and energy efficiency. Nidec Global Appliance is a division of Nidec Corporation, a global leader in motors and components for a wide variety of industries, with headquarters in Japan. For further information, access the company profile.

### 主要展品 /Products

压缩机和电机

motors and compressors



宁波埃玛电器制造有限公司

E2-2A06

地址: 宁波市鄞州区邱隘镇回龙村 (315101)

电话 /Tel: 057488220946

传真 /Fax: 0574-88220945

网址 /Web: [www.chinaelmar.com](http://www.chinaelmar.com)

宁波埃玛电器始于 2012 年。公司积累了丰富的设计研发和生产制造经验, 产品种类的不断增长, 生产规模的不断扩大, 宁波埃玛电器现已发展成一家集研发、设计、制造、销售和服务于一体的综合性企业。团队自主研发的玻璃清洗机, 手持式高温蒸汽清洗机, 便携式挂烫机, 蒸汽拖把, 家用搅面机, 去毛球器等产品凭借着款式新颖, 实用性强的特点, 远销海内外全球 150 多个国家与地区。

Ningbo Elmar Electric manufacture Co., Ltd established in 2012, specializes in the manufacture of small home appliances. Our products include steam cleaner, steam brush, stand mixer, window vacuum cleaner, vacuum cleaner, blender, air fryer, steam mop and and more.

The factory strictly follows the ISO9001 international quality management system. Our company can also carry out product design and development according to customer specifications. We focus on technological innovation. Our design and development team are established within the company. Our products include several inventions, utility models and patents. Products all include CE, GS, ETL, SAA, PSE, CB, KC, ERP, LVD, LFGB, REACH, RoHS, 14000, BSCI etc. Products are sold in more than 150 countries and regions around the world. The main foreign markets are Europe, the United States, Japan and South Korea, and cooperation with major supermarket chains in Europe and America.

### 主要展品 /Products

蒸汽清洗机, 蒸汽拖把, 蒸汽刷, 搅面机, 玻璃清洗机, 牙刷消毒器, 毛球处理器, 冰箱消毒器  
steam cleaner, steam mop, garment steamer, stand mixer, window vac cleaner, tooth sterilizer,  
fabric shaver, fridge sterilizer

**AIRPLUS®****宁波爱科特环境电器有限公司****NINGBO AQUART ENVIRONMENTAL APPLIANCE CO., LTD****E2-2F81**

地址: 浙江省宁波市慈溪杭州湾新区滨海大道 298 号

Add: 298 Binhai Avenue, Hangzhou Bay New District, Ningbo, 315336, China

电话 /Tel: 0574-56336187

网址 /Web: www.airplus-world.com

AIRPLUS 品牌注册于美国独立战争时的首都 - 费城 (Philadelphia), 宾州最大城市拥有悠久的历史及底蕴。

2018 年, 沁园集团创始人叶建荣先生与美国 AIRPLUS 达成战略合作, 收购其电器业务, 随即引进美国 AIRPLUS 优秀的研发设计工程师以及爱科特集团 (原联合利华, 沁园国际贸易部) 的技术力量和管理团队, 并在中国宁波建立研发与生产基地, AIRPLUS 艾普莱斯中国应运而生。

**主要展品 /Products**

除湿机, 空气消毒净化机, 衣物护理机, 冰箱消毒器, 新风机, 车载消毒器, 取暖器, 移动空调

**ANJA 安佳****宁波安佳卫厨电器有限公司****N2-2F91****Ningbo Anjia Sanitary Kitchenware & Electrical Appliance Co., Ltd.**

地址: 浙江省宁波奉化区方桥街道方桥工业区方欣路 25 号 (315514)

电话 /Tel: 0574-88651687

传真 /Fax: 0574-88651687

网址 /Web: http://www.anja.cn/

ANJA 安佳品牌创始于 1999 年, 集厨房和住宅装配产品的研发智造, 销售服务为一体。作为中国厨电橱柜领域的先行者, 中国制造嵌入式消毒柜的历史, 从安佳开始。对厨房生活的深刻理解, 让安佳品牌走向卓越。20 多年的发展历程, 安佳, 从厨房开始, 不断为居家生活置入智慧与关怀。

**主要展品 /Products**

橱柜, 嵌入式烤箱, 嵌入式蒸箱, 嵌入式蒸煮一体机, 嵌入式消毒柜, 嵌入式洗碗机, 吸油烟机等多条产品线。

**ann  
semic****宁波安芯美半导体有限公司****N1-1A43 1A44****NINGBO ANN SEMICONDUCTOR., LTD**

地址: 浙江省宁波杭州湾新区玉海东路 136 号数字经济产业园 B 区 14 号楼 (315336)

电话 /Tel: 0574-58010899

传真 /Fax: 0574-58010897

网址 /Web: www.annsemic.com

宁波安芯美半导体有限公司成立于 2020 年 12 月, 注册资本 1.5 亿元, 总投资 6.6 亿元, 以研发、生产、销售高端消毒杀菌用 UVC-LED 外延、芯片、灯珠、模组以及终端成品为主, 年产 UVC-LED 灯珠 1.8 亿颗, UVC 技术处行业领先地位。

Ningbo Ann Semiconductor Co., Ltd is located in Ningbo Hangzhou Bay New Zone. As a high-tech enterprise focused on investment promotion by the Hangzhou Bay New District Government, it is mainly engaged in research and development, production, sales of high-end sterilizing UVC epitaxy, chip, package and module. Partially based on special lighting and compound semiconductor chip core material, it belongs to the third generation of semiconductor materials. With a total investment of ¥660 million CNY and an area of 16.47 acres, the project plans to build 10 epitaxy, chip and 15 packaging production lines, with an annual output of 100,000 2-inch deep ultraviolet chips and 180KK packaging products, and actively layout application end and infra-red related technologies.

**主要展品 /Products**

公司拥有 UVC-LED 外延、芯片、灯珠、模组系列产品, 可广泛应用于表面杀菌、静态水杀菌、动态水杀菌、食品杀菌、空气杀菌等场景, 产品通过权威机构检测认证, 质量过硬, 安全可靠, 杀菌率高, 支持产品定制。

Our entire UVC industry chain is sufficient to meet your needs for various products and applications in the UV and UVC field.

UVC Epitaxy: 260~280nm Al2O3, SiC, Si, GaN, ZnO LED Substrate for different uses.

UVC Chips: ROHS, REACH Standard, high brightness, high reliability, low leakage, long life.

UVC-LED: 2-110mW, various brightness, size available for different sterilization needs.

UVC Modules: Widely used in surface, static water, dynamic water, food and air sterilization

**Maxwin****宁波翱尔昆电器有限公司****N3-3H96****Ningbo Awesome Electric Appliance Co., Ltd.**

地址: no.16 tian longshan road, da qi street, beilun (315806)

电话 /Tel: 057486119778

公司位于宁波市北仑区, 紧邻北仑港, 物流海运便捷。主营咖啡手冲壶, 玻璃茶壶, 泡茶壶和咖啡周边产品, 在与客户 10 多年互赢合作中, 不断创新, 提供可靠价值。产品出口全球的同时, 国内运营 Maxwin 品牌, 品质上乘, 旨在给消费者手冲咖啡的专业体验。产品优雅小巧的设计, 巧妙融入优雅生活空间, 给生活增添美好的情趣。

**主要展品 /Products**

咖啡手冲壶, 玻璃茶壶, 复古电热水壶, 磨豆机

hand drip kettle, glass tea maker, classic electric kettle, hand grinder

**宁波佰森厨具有限公司****N3-3B23****NINGBO BAISHEN KITCHENWARE CO., LTD**

地址: 宁波市鄞州五乡镇宝同路 29 号 (315000)

电话 /Tel: 86-0574-88486969

传真 /Fax: 86-0574-88486969

网址 /Web: www.anmur.com

我司是以原创设计为核心的设计 / 生产 / 销售为一体的公司

**主要展品 /Products**

微压锅及厨房配件

## 拓彼 TuoBi

宁波柏森智能科技有限公司

**NINGBO BAISEN INTELLIGENT TECHNOLOGY CO.,LTD**

**N3-3B41**

地址: 浙江省慈溪市新浦金沅工业区 10-1-1 (315322)

Add: Industrial Zone, Xinpu Town, Cixi, Ningbo Zhejiang, China

电话 /Tel: 13486088887

专业生产 磨豆机, 咖啡机, 奶泡机, 绞肉机, 多士炉, PCB 线路板等。

Specializing in the production of coffee grinders, coffee machines, milk frothers, meat grinders, toasters, PCB circuit boards, etc.

### 主要展品 /Products

磨豆机, 咖啡机, 奶泡机, 绞肉机, 多士炉, PCB 线路板

coffee grinders, coffee machines, milk frothers, meat grinders, toasters, PCB circuit boards

宁波宝亿德电器有限公司

**ningboBalyideElectricApplianceCoLtd**

**W1-1B22**

地址: 余姚市朗霞街道天中村进士第路 85 弄 3-1

电话 /Tel: 0574-62100895

传真 /Fax: 0574-62100895

宁波宝亿德电器有限公司是一家从事倾倒开关、微动开关、旋转开关等家用电器配件源头厂家, 坐落在浙江省余姚市, 年生产开关 1000 万只, 具有独立产品设计、开发、生产和服务能力。产品均通过, CQC、ETL、TUV、CB、CE 等国际安全认证。并通过 ISO9001: 2015 国际质量体系认证。企业秉承“顾客至上, 锐意进取”的经营理念, 坚持“客户第一”的原则为广大客户提供优质的服务。欢迎惠顾!

### 主要展品 /Products

倾倒开关, 旋转开关, 微动开关、液涨式温控器

## 雪西子

宁波博晟电器有限公司

**Ningbo Bosheng Electric Co.,Ltd**

**E3-3E86**

地址: 浙江省余姚市泗门镇云环工业园

电话 /Tel: 0574-62128848

网址 /Web: www.cnbosn.com

宁波博晟电器有限公司成立于 2010 年, 是一家专业从事电子冷暖箱研发, 生产与销售于一体的企业。现根据市场需求, 推出化妆品冷藏箱产品。产品已取得国内 3C 认证, 相关国际认证稳步推进中。我司备有现货, 支持一件代发, 寻求有志之士, 共同开拓化妆品冷藏箱市场。

### 主要展品 /Products

化妆品冷藏箱 (美妆冰箱)

## JOIL

宁波朝一电子有限公司

**Ningbo Joil Electronics Co.,Ltd.**

**E2-2A25**

地址: 浙江省宁波市慈溪市掌起镇万洋 (掌起) 众创城 25 号楼 <2-1> 室

Add: 2F, Building No.25, WanYang, ZhangQi, Cixi, ZheJiang, China.

电话 /Tel: 18792860632

网址 /Web: https://nbjoil.1688.com/

宁波朝一电子有限公司是一家主营小家电研发制造销售为一体的综合公司。主营电风扇, 取暖器等小家电产品。公司坚持以人为本, 严格监督, 创新技术来提升产品品质, 并以此让消费者生活的更舒适、更轻松、更美好。

### 主要展品 /Products

电风扇, 循环扇, USB 风扇, 取暖器

Electric Fan, USB Fan, Air Circulator Fan, Electric Heater



宁波德茨工业科技有限公司

**NINGBO TEXZE INDUSTRIAL TECHNOLOGY CO., LTD**

**W4-4B14**

地址: 宁波鄞州区五乡工业区三江路 203 号 (315100)

Add: NO.203 SANJIANG ROAD, WUXIANG INDUSTRIAL AREA, YINZHOU, NINGBO

电话 /Tel: 0086-574-88233379

传真 /Fax: 0086-574-27785636

网址 /Web: WWW.TEXZE.COM

我司主要自主研发设计和生产便携式洗衣机, 迷你洗衣机, 迷你干衣机。

OUR COMPANY IS A PROFESSIONAL DESIGNER AND PRODUCER OF PORTABLE WASHING MACHINE, MINI WASHING MACHINE, MINI CLOTHES DRYER.

### 主要展品 /Products

便携式洗衣机, 迷你洗衣机, 迷你干衣机

PORTABLE WASHING MACHINE, MINI WASHING MACHINE, MINI CLOTHES DRYER.



宁波德业家用电器科技有限公司

地址: 浙江省慈溪滨海经济开发区日显南路 568 号 3 幢

电话 /Tel: 13616786837

**W2-2F51**

宁波德业家用电器科技有限公司创建于 2003 年; 是一家集研发、设计、生产、销售、服务为一体的空气处理设备专业制造商; 主营产品有家用除湿机、工业除湿机、新风除湿机、管道吊顶除湿机、转轮除湿机、除湿加湿一体机、恒温恒湿机及各类空气处理非标定制设备。近二十年来, 德业始终专注于空气环境改善型设备的研发和制造, 致力为万千家庭打造更舒适、更健康的生活环境。

**主要展品 / Products**

主营产品有家用除湿机、工业除湿机、新风除湿机、管道吊顶除湿机、转轮除湿机、除湿加湿一体机、恒温恒湿机、移动空调、加湿器、太阳能空调及各类空气处理非标定制设备。

**宁波鼎安电器有限公司****NINGBO DINGAN ELECTRIC APPLIANCE CO., LTD****W2-2D66**

地址: 浙江省慈溪市宗汉新兴东一路 19 号

电话 / Tel: 15888582949

宁波鼎安电器有限公司坐落于杭州湾跨海大桥南岸, 地理位置优越, 交通便利。成立 20 余年来, 凭借先进的制造设备、专业的研发团队、雄厚的开发实力, 相继开发生产反渗透净水机、管线机、超滤净水器、中央净水器、软水机、大型水处理设备等七大系列近百种产品, 远销欧美等 10 多个国家和地区。同时依靠多年积累的行业信誉, 赢得了国内外众多企业的信赖, 建立了密切而友好的合作关系。

**主要展品 / Products**

净水器及配件

**宁波凡浦智能科技有限公司****Ningbo VEMPU Intelligent Technology Co., Ltd,****E1-1E51**

地址: 浙江省宁波市慈溪市观海卫镇工业东区三海路 46 号 (315315)

Add: East District, industrial park, Guanhaiwei town, Cixi City

电话 / Tel: 13738003093

传真 / Fax: 慈溪市观海卫镇工业园东区

网址 / Web: www.vempu.com

宁波市凡浦智能科技有限公司, 作为荷兰皇家飞利浦 (Royal Philips) 在大中华区空调扇和取暖器领域的唯一授权合作伙伴, 秉承飞利浦“创新为你”的品牌承诺, “创新, 以人为本”的动力核心, 研发、制造、销售满足人们需求的, 真正能够帮助到人们的产品!

Ningbo VEMPU Intelligent Technology Co., Ltd, as the only authorized partner of Royal Philips in the field of air-conditioning fans and heaters, is adhering to the Philips brand promise of "Innovation for you" and the driving force of "Innovation and people-oriented". R&D, manufacturing, and sales of products that meet people's needs and can truly help people.

**主要展品 / Products**

空调扇、循环扇、无叶扇、空调扇、冷风扇、电热取暖器

Cooling、Heating



因爱伟大

**宁波方太厨具有限公司****Ningbo Fotile Kitchen Ware Co., Ltd.****N1-1F11**

地址: 浙江省宁波市杭州湾新区滨海六路 1266 号 (315336)

电话 / Tel: 0574-23456731

传真 / Fax: 0574-23456731

网址 / Web: www.fotile.com

方太集团创建于 1996 年, 是以智能厨电为核心业务的幸福生活解决方案提供商, 为人们提供高品质的产品和服务。目前已形成集成烹饪中心、吸油烟机、水槽洗碗机、嵌入式洗碗机、净水机、嵌入式灶具、嵌入式消毒柜、嵌入式微波炉、烤箱、蒸箱、燃气热水器等多条产品线。国家发明专利数量位居行业翘楚地位, 斩获业内多项设计、技术类大奖, 拥有行业内实力雄厚的研究院。方太积极承担社会责任, 致力于导人向善, 促进人类社会的真善美。

Founded in 1996, FOTILE Group is a happy life solution provider with intelligence kitchen electricity as its core business, providing high-quality products and services for people. The current 11 product lines include integrated cooking center, range hoods, sink dishwashers, embedded dishwashers, water purification machine, embedded hobs, embedded steamer-microwave oven integrated machine, embedded steam ovens, embedded electric ovens, embedded disinfection cabinet, embedded microwave ovens, gas water heaters and refrigerator. The number of national invention patents ranks among the leaders in the industry, has won a number of design and technology awards in the industry, and has a strong research institute in the industry. In its daily business, FOTILE makes constant efforts in practicing social responsibility, passionately engaging in promoting Chinese Culture, charity and environmental protection.

**主要展品 / Products**

集成烹饪中心、吸油烟机、水槽洗碗机、嵌入式洗碗机、净水机、嵌入式灶具、嵌入式消毒柜、嵌入式微波炉、烤箱、蒸箱、燃气热水器、冰箱

integrated cooking center, range hoods, sink dishwashers, embedded dishwashers, water purification machine, embedded hobs, embedded steamer-microwave oven integrated machine, embedded steam ovens, embedded electric ovens, embedded disinfection cabinet, embedded microwave ovens, gas water heaters and refrigerator.

**宁波方太营销有限公司 - 米博****MIBOI****N1-1F01**

地址: 浙江省宁波市杭州湾新区滨海六路 1266 号方太理想城 (315336)

电话 / Tel: 0574-23456731

传真 / Fax: 0574-23456731

网址 / Web: www.miboi.com

米博 (miboi) 定位为高端清洁电器专家, 主张“科技智善”, 立志用创新科技为亿万家庭带来全新的“无布”清洁体验, 提供洁净舒适的新生活方式。

**主要展品 / Products**

米博无滚布洗地机, 在传承和借鉴了方太深耕多年的油烟机、洗碗机核心技术的基础上, 针对传统滚



布型洗地机带来的二次污染、滚布发臭、清理麻烦等问题,发明了水气旋强效洗吸技术,将传统洗地机依靠滚布拖擦的清洁方案,升级为水气旋的高能流体冲洗和高速无滚布地刷擦洗结合的清洁方案,彻底解决了传统滚布带来的清洁和体验问题,引领行业进入无布洗地新时代!  
米博无滚布洗地机,强洗除菌不沾污,无滚布,更干净。



### 宁波飞芯电子科技有限公司

**Ningbo ABAX Sensing Electronic Technology Co., Ltd.**

地址: 西安市长安区毕原二路 3000 号 硬科技企业社区 7 号楼 (710119)

电话 /Tel: 029-88859334

传真 /Fax: 029-88859334

网址 /Web: www.abax-sensing.com

飞芯电子成立于 2016 年,是一家从事全固态激光雷达及其核心芯片研发设计的高科技企业。公司拥有国内外自主知识产权三百余件,研发实力雄厚。历史融资过亿元。飞芯电子致力于做一家面向各类应用领域利用各类探测机理提供各类收发端芯片的 3D 传感器芯片设计公司。

公司产品主要应用于车载,消费电子、工业、军用等领域。其中消费电子领域主要包含手机、扫地机器人、智能门锁、智能电视、平板、投影仪等智能家居领域。

#### 主要展品 /Products

- 远距离强抗干扰 ITOF 深度图像传感器芯片
- 3.5um 低功耗自校准 ITOF 接收阵列芯片
- 远距离车规级固态激光雷达  
具备高可靠、强抗同类设备干扰能力、低成本特点。
- 近距离车载激光雷达模组  
产品结构简单,具备高分辨率、低成本特点。
- 扫地机用激光雷达模组  
具备强抗背景光能力、高集成度、低成本优势。
- 手机辅助对焦模组  
具有高集成度、小尺寸等特点,可实现辅助对焦等精准测距等功能。



### 宁波福瑞电子科技有限公司

**NINGBO FOURA ELECTRONICS CO., LTD**

地址: 宁波市鄞州区泰康大厦 1213 室 (315000)

Add: ROOM 1213 TAIKANG BUILDING YINZHOU DISTRICT, NINGBO

电话 /Tel: 88325681

传真 /Fax: 00000000

网址 /Web: www.cnfoura.com

宁波福瑞电子科技有限公司成立于 2018 年,我们是一家集家用吸尘器,地毯机,干湿两用吸尘器产品的研发,制造,销售为一体,拥有 20 年的 floor care 外贸经验,不断推广物美价廉的优质产品。公司有着雄厚的实力,重信用、守合同,始终坚持诚信为本、质量优先、价格合理、服务优质,以多品种经营特色和薄利多销的原则,赢得了广大客户朋友们的信任和喜爱。

Ningbo Foura Electronics Co., Ltd. was founded in 2018, we are a collection of cordless/corded

vacuum cleaners, carpet washer, dry&wet vacuum cleaner and other products research and development, manufacturing, sales as one. With 20 years of floor care experience in trade, we constantly promote high-quality products at affordable prices. The category of products is complete and the price is reasonable. We emphasize credit and focus on the quality of products. Through the best quality service, we win the trusts and praises of our customers.

#### 主要展品 /Products

无线真空吸尘器; 洗地机; 地毯机  
cordless vacuum cleaner; hard floor washer; carpet washer



### 宁波富达智能科技有限公司

**NINGBO FUDA INTELLIGENT TECHNOLOGY CO., LTD.**

地址: 浙江省宁波市余姚市泗门镇振华路 1 号 (315400)

Add: No.1 Zhenhua Road, simen Town, Yuyao, Zhejiang, China

电话 /Tel: 0574-62500136

传真 /Fax: 0574-62500136

网址 /Web: www.fuda-china.com

宁波富达智能科技有限公司作为国内工业除湿机、家用除湿机、移动空调、空调扇行业的先行者,致力于空气温度、湿度、洁净度领域产品的研发与制造。经过多年的努力,在全球有 26 个国家与地区已经拥有广泛的合作客户,作为生产商,为他们提供优质产品及服务。其中不乏有德龙、惠而浦、EASY HOME、TTI 等国际知名品牌商。

Ningbo Fuda Intelligent Technology Co., Ltd. is located in Yuyao city, Zhejiang province P.R.

China, nearby Shanghai and Hangzhou. This city is known as the Plastic City of China. Our 40,000 square meters factory has over 415 employees. Last year, our annual sales exceeded 40 million USD. Our success is based on the production of high-quality products, very strict quality control, leading Research and Development (R&D), global sales network, and satisfactory customer services.

#### 主要展品 /Products

除湿机、移动空调、空调扇  
dehumidifier, Mobile air conditioner, Air conditioning fan



### 宁波富爵电子科技有限公司

**Ningbo Fulljoy Electronic Technology Co., Ltd.**

地址: 浙江省宁波市奉化区经济技术开发区汇源路 108 号 (315500)

Add: 108, Huiyuan Road, Fenghua Economic and Technological Development Zone, Ningbo, Zhejiang

电话 /Tel: 0574-88923969

传真 /Fax: 0574-88682615

网址 /Web: https://fulljoy1688.1688.com/

宁波富爵电子科技有限公司于 2011 年成立公司,座落于浙江省第二大城市、江南水乡兼海港城市

宁波, 是一家集研发、设计、生产、销售、服务于一体的民营高科技企业。我们以“为客户提供最好的产品, 最好的技术支持, 健全的售后服务”为宗旨, 赢得了广大客户的信赖。公司通过了 ISO9001 质量体系认证、ISO13485 质量管理体系认证, 产品获得了 CE、CB、ETL、RoHs, PSE, FCC, FDA 等多项国际专业认证。

Ningbo fulljoy Electronic Technology Co., Ltd was established on 2011. It is located in Ningbo, the second largest city in Zhejiang Province, a water town and seaport city in the south of the Yangtze River. It is a private enterprise integrating R&D, design, production, sales and service. High-tech enterprises. Over the years, we have established an experienced R&D team and sales team with the tenet of "providing production, sales and service. High-tech enterprises. Over the years, we have established an experienced R&D team and sales team with the tenet of "providing customers with the best products, best technical support, and sound after-sales service", which has won the trust of our customers. The company has passed ISO9001 quality system certification, ISO13485 quality management system certification, and its products have obtained CE, CB, ETL, RoHs, PSE, FCC, FDA and other international

#### 主要展品 / Products

护眼仪、颈椎按摩仪、足疗机、手部按摩仪、膝盖按摩仪

Eye Protector, cervical massage machine, foot massage machine, hand massage machine, knee massage machine



#### 宁波格瑞塑业有限公司 Ningbo Gerui Plastic Co., Ltd

地址: 宁波市奉化区尚田街道尚兴路 13-1 号 (315500)

电话 / Tel: 13567479995

传真 / Fax: 0574-88927712

我们主要生产塑料齿轮箱, 精密模具  
we produce gear box and mold

#### 主要展品 / Products

齿轮箱, 风叶

gear box, mold, fans



#### 宁波广旭电器有限公司 Ningbo Guangxu Electric Appliances Co., Ltd.

地址: 浙江省慈溪市周巷镇开发东路 689 号 (315324)

Add: No. 689 Development East Road, Zhouxiang Town, Cixi, Ningbo, Zhejiang Province, China

电话 / Tel: 0574-63315667

传真 / Fax: 0574-63315687

网址 / Web: www.yunikly.com

宁波广旭电器有限公司成立于 2015 年, 地处浙江省慈溪市周巷镇工业区, 毗邻杭州湾, 交通十分便利。

E1-1B02

N3-3B16

广旭电器有限公司是专业设计, 生产和销售折叠电蒸箱、折叠多功能料理锅和微晶玻璃烤盘。“健康生活”是广旭公司的企业宗旨, 它鼓舞着公司全体员工为顾客提供一流的产品和优质的服务。

NINGBO GUANGXU ELECTRIC APPLIANCES CO., LTD. (Yunikly) is established in 2015, located in Zhouxiang town, Cixi city, Zhejiang province, which is closed to Ningbo port and Hangzhou Bay with good transportation.

We are specialized in designing, manufacturing and selling foldable food steamers, foldable multifunctional pot and glass grills. "Healthy life" is our corporate purposes, it encourages all our employees to provide customers with first-class products and quality service.

#### 主要展品 / Products

折叠蒸锅、圆形电蒸锅、折叠多功能锅、微晶玻璃烤盘、韩式无烟电烤炉、超声波清洗机

Foldable food steamer, Round electric steamer, Foldable multi-function pot, Glass-ceramic Electric Grill, Smokeless electric grill, Ultrasonic Cleaner



#### 宁波海燕新材料有限公司 Ningbo Haiyan New Material Co., Ltd.

地址: 宁波市北仑大榭王隘工业园区茅洋山路 515 号 (315806)

Add: No. 515, MaoYangShan Rd, Daqi, Beilun, Ningbo, Zhejiang, China

电话 / Tel: 0574-86113200

传真 / Fax: 0574-86113208

网址 / Web: <http://www.haiyanglass.com.cn/>

宁波海燕家电玻璃技术有限公司始创于 1999 年, 专业生产家用电器配套的特种玻璃, 现有员工 160 人, 其中专业从事技术人员 45 人, 拥有年产 2000 万片钢化玻璃、硼硅玻璃生产能力, 每年设备研发投入不少于年产值的 3%, 是宁波市级企业技术中心、市高新技术企业。2022 年公司销售产值近亿元, 产品包括硼硅玻璃、钠钙钢化玻璃、离线 LOW-E 镀膜玻璃等系列, 广泛应用于微波炉、烤箱、电磁炉、洗碗机等多类家电。

Establishment: in year 1999. Leading manufacturer of home appliance glass (Tempered and borosilicate glass).

Main Products: Microwave base plate and door glass, Oven door glass, Oven control panel glass, Induction cook panel, etc.

Main Clients: Galanz, Gorenje, Mora, Hisense, Panasonic, Toshiba, Sharp, Samsung, Vestel, Midea, etc.

Total area: 12,000 square meters.

Total sales turnover 2022: Nearly USD 15 millions

Certification: ISO9001:2015, ISO14001:2015, ISO45001:2018

#### 主要展品 / Products

产品包括硼硅玻璃、钠钙钢化玻璃、彩晶玻璃等系列, 广泛应用于微波炉、烤箱、灶具、抽油烟机、冰箱等多类家电

Products include borosilicate glass, soda lime glass, Display Glass series, widely used in microwave, oven, stove, range hood, refrigerator and other types of home appliances.

W1-1B02



### 宁波航丰电器有限公司

#### Ningbo Hangfeng Electric Appliance Co., Ltd.

**N3-3A30 3A31**

地址: 浙江省宁波市余姚市泗门镇纬五路东段 9 号 (315470)

Add: #9 Weiwu Road East Section, Simen Town, Yuyao city, Zhejiang Province, China

电话 /Tel: 13905848659

传真 /Fax: 0086-0574-58221161

网址 /Web: www.nb-hangfeng.com

宁波航丰电器有限公司成立于 2022 年 4 月,是集设计、研发、生产、销售和服务家用电器,厨房电器,小家电空气炸锅和空气烤箱为一体的民营企业。公司目前有员工 80 余人,厂房面积 7000 多平方米,2 条整机生产装配线,专利证书 20 余项,拥有各类生产设备 30 多台,CCC, CE, CB 等认证证书 10 余项,产品畅销国内外。我们秉持“客户至上、合作共赢”的经营理念,竭诚为海内外客商提供更具竞争力的产品和优质的服务!

Ningbo Hangfeng manufacture was established in April 2022 and is a private enterprise integrating the design, research, development, production, and sales of small kitchen appliances, air fryers, and air fryer ovens. Hangfeng has more than 80 employees, a plant area of more than 7000 square meters, 2 whole production and assembly lines, more than 20 patent certificates, more than 30 sets of various production equipment, more than 10 certificates of BSCI, CE, CB and other certifications, and dedicated to providing more competitive products and quality service for customers at home and abroad!

#### 主要展品 /Products

家用电器, 厨房电器, 小家电, 空气炸锅, 空气烤箱

Household appliances, kitchen appliances, small appliances, air fryer, air fryer oven



### 宁波横河精密工业股份有限公司

#### Ningbo Henghe Precision Industry Co., Ltd.

**E1-1H81**

地址: 浙江省慈溪市宗汉街道新兴大道 588 号 (315300)

Add: No.588 Xinxing Road, Zonghan Street, Cixi, Zhejiang, PRC

电话 /Tel: 0086-574-63268129

传真 /Fax: 0086-574-63265678

网址 /Web: www.mouldcenter.com

宁波横河精密工业股份有限公司始建于 1992 年,于 2016 年 8 月在深交所上市(股票代码:300539)。公司是全球超精密模具及产品供应商。主要为家电、汽车、卫生洁具、电子、医疗器械等行业客户提供从产品设计、模具制造、成型生产及组装的一站式服务。

Ningbo Henghe Precision Industry Co., Ltd., founded in 1992, was listed on Shenzhen Stock Exchange in August 2016 (stock code: 300539). The company is a global supplier of ultra-precision molds and products. Mainly for household appliances, automobiles, sanitary ware, electronics, medical equipment and other industries to provide one-stop service from product design, mold manufacturing, molding production and assembly.

#### 主要展品 /Products

360°桶形复合滤网,三重过滤按键操作,简单方便,指示灯显示一目了然激光粉尘传感器,精准检测 PM2.5 浓度液晶显示器,PM2.5 数字显示浓度温湿度显示,三色灯光区别空气质量 DC 高性能点击,提供澎湃动力,更低噪音内置负离子,补充室内负离子浓度让空气更加清新滤网更换智能提示 AUTO 模式,感应环境空气质量,自动调速 Wifi 手机控制(增选)

360° barrel composite filter screen, triple filter button operation, simple and convenient, indicator light display at a glance laser dust sensor, accurate detection of PM2.5 concentration LCD, PM2.5 digital display concentration of temperature and humidity



### 宁波华联电子科技有限公司

#### NingBo Hualian Electronic Science & Technology Co., Ltd

**N4-4A21 4A22**

地址: 浙江省杭州湾新区庵东镇工业园区纬三路 (315327)

Add: Wei san RD, Andong Industrial Zone Hangzhou Bay New area Zhejiang China 315327

电话 /Tel: 86-574-63477199

传真 /Fax: 86-574-63472268

网址 /Web: www.nbhle.com

宁波华联电子科技有限公司是一家专注于光电显示产品制造及服务的综合性公司,专业生产高新技术产品 LED 数码管显示器、ITO 电容触摸式按键开关、PCBA,在行业内拥有领先地位。

垂直整合显示屏,控制板,触摸屏片,照明资源,与模具注塑形成配套能为客户解决多方面的显示开发设计及系统模组设计。

Ningbo Hualian Electronic Science & Technology Co., Ltd. was founded in 1990. It has convenient geographical position which located at the south bank of Hangzhou Bay and in the south of Hangzhou Bay Bridge closed to Shanghai, Hangzhou, Ningbo, Suzhou, about two hours drive. It covers an area of 70 thousand square meters.

Hualian Electronic focuses on producing and customizing 7 segment LED displays and SMD LED displays for SAMSUNG, GEA, AVAGO, Midea, Sanyo, Hisense and other international famous customers in Electronics. Products are mainly exported overseas.

Hualian Electronic can make new customized samples in a short time with its own design team and tooling workshop with short new samples lead time. In the mass production line, Hualian have 85% automatic process with a short lead time for mass production.

#### 主要展品 /Products

LED 数码显示屏、LED 数码管、PCBA 控制板模块、ITO 电容式触摸屏片  
seven segment led display, PCBA module, ITO touch film

## Huayi

宁波划一马达有限公司  
Ningbo Huayi Motor Co., Ltd

N1-1A45,W1-1A05

地址: 浙江省余姚市远东工业城 CW3  
电话 /Tel: 0574-62760000  
网址 /Web: www.mada.cn

宁波划一马达有限公司拥有先进 CAD/CAM/CATIA 技术和先进的生产检测设备, 以及 ISO9001 质量管理体系保证, 已具备月生产马达 100 万只的生产能力。

公司生产的同步马达, 步进马达, 罩极马达广泛应用于微波炉、空调、洗衣机、冷暖风扇、烤箱等家用电器、自动机器、自动控制设备等。部分产品都通过 CCC、UL、VDE、CE 等国内外安全认证, 产品 95% 出口欧美国家。

Ningbo Huayi Motor limited has become evolved into a modern factory of more than 20,000 square meters and fixed assets of more than USD 7,000,000 with the combined capacity to design,develop,manufacture and market its range of products.

Utilising state of the art CATIA/CAD/CAM facilities and up to date production testing equipment,together with ISO9001,ISO14001 quality assurance system,we can produce over 1,000,000 motors per month.

With 10 or more categories and 600 or more models of synchronous,step and shaded-pole motors that our company can produce are suitable for application in microwaves oven, airconditioner, washing machine,refrigerator,heating/cooling apparatus,barbeques, video games and other domestic appliances, as well as in robotics,office equipment,stage lighting,toys and gifts. Some of our products have attained C-UL,VDE,TUV,SAA,U-CSA,CE and CCC,local and international safety standard approval.95% of our products are exported to USA and Europe.

### 主要展品 /Products

烤箱同步马达, 可控同步马达, 罩极马达, 罩极变速马达, 循环风机, 贯流风机, 烧烤驱动马达, 油烟机马达, 磁滞马达, 直流无刷马达

synchronous motor of oven,controllable synchronous motor,stepping motor,shaded pole motor,shaded pole change speed motor,fan blade shaded pole motor,cross flow fan,barbecue driving motor,motor of range hood,hysteresis motor,EC motor



宁波佳迈智能科技有限公司  
Ningbo Ubetter Intelligent Technology Co.,Ltd.

W4-4B38

地址: 浙江省余姚市三七市镇云山中路 28 号 (余姚人才创业园内)  
电话 /Tel: 057483063862

宁波佳迈智能科技有限公司是一家集自主研发、生产、销售为一体的科技型企业。公司目前员工有 300 余人, 在宁波本部和深圳各拥有一处产品研发中心, 技术研发团队共有 30 多人。

公司主要产品涵盖耳鼻咽喉健康护理系列, 美发系列, 家用电子灌肠保健系列等产品。

公司已通过 ISO13485:2016, ISO9001:2015, BSCI 认证等体系认证, 美国 FDA 医疗注册产品达 50 多项。

### 主要展品 /Products

电吹风、直发器、洗耳机、干耳器、可视掏耳勺、吸鼻器等

## Jiayin 佳音科技

宁波佳音机电科技股份有限公司  
NINGBO JIAYIN ELECTRO MECHANICAL TECHNOLOGY CO., LTD

N1-1A01

地址: 浙江省余姚市兰江街道肖东工业园区高畈路 22 号 (315400)  
Add: NO.22 Gaofan Road,Xiaodong Industrial Area,Yuyao,Zhejiang,China  
电话 /Tel: 13858298601  
传真 /Fax: 0574-62598655  
网址 /Web: www.yyjiayin.com

佳音科技成立于 2001 年, 是国家级高新技术企业, 主要生产智能家电所需的电磁阀、电磁泵、电机泵等执行器系列产品, 以及部分控制及传感器相关产品, 目前拥有 20 个事业部, 基本能为智能家电提供“一站式”解决方案;

2016 年新三板挂牌, 已全面搭建了数字化平台, 实现了研发—销售—供应链—生产—物流的全面信息化; 佳音在册员工 720 多人, 其中技术人员近 80 名, 目前正探索和完善“合伙人 + 股东”事业部制的治理模式。

Founded in 2001, Jiayin technology is a national high-tech enterprise, which mainly produces actuator series products such as solenoid valve, solenoid pump, motor pump and electric valve required by smart appliances, as well as some control and sensor related products. At present, it has 20 business divisions, which can basically provide "one-stop" solutions for smart appliances; In 2016, the new third board was listed, and a digital platform has been fully built, realizing the comprehensive informatization of R & D - Sales - supply chain - production - logistics; Jiayin has more than 720 registered employees, including nearly 80 technicians. At present, it is exploring and improving the governance mode of "partner + shareholder" business division system.

### 主要展品 /Products

电磁阀、净水阀、燃气阀、电磁泵、膜片泵、电机泵、增压泵、洗碗机配件 (呼吸器、软水器等)、传感器 (流量计、NTC 等)、热传导

Solenoid valve, water purification valve, gas valve, Vibration pump, diaphragm pump, motor pump, booster pump, dishwasher accessories (respirator, water softener, etc.), sensor (flowmeter, NTC, etc.), heat conduction

CHINWE  
嘉汇

宁波嘉汇智能科技有限公司  
NINGBO CHINWE TECHNOLOGY CO., LTD.

E3-3A27

地址: 中国浙江省宁波市鄞州区药水港工业区 A 座 17# (315000)  
Add: 17#-A.fengshuigang Industrial parkinzhou Ningbo City China  
电话 /Tel: 0574-87458880  
传真 /Fax: 0574-87466916  
网址 /Web: www.chinwe.cn

宁波嘉汇智能科技有限公司成立于 2008 年, 注册资金 600 万, 公司员工 20 余人, 是浙江省一家专业化化妆镜、led 镜等多项镜子的企业, 凭着先进的技术、卓越的品质、完善的服务, 我公司生产的



产品无论是在美观性还是实用性都属于行业领先。我们用心倡导：以市场为导向，以科研为龙头，以创新为手段，用心开拓国内外市场。

#### 主要展品 / Products

智能化妆镜 . led 落地镜 . 智能卫浴镜



#### 宁波嘉林电子有限公司

#### NINGBO JIALIN ELECTRONICS CO.,LTD

E2-2B05

地址：浙江省宁波市北仑区大港工业城南海路72号（崂山路1号）(315800)

Add: NO.1 Laoshan RD, Dagang Industrial Park, Ningbo, China

电话 /Tel: 0574-86886766

传真 /Fax: 0574-86872966

网址 /Web: www.microswitch.biz

本公司（品牌 DONG HAI）专业生产全系列微动开关等器具开关用于军工，汽车，电动工具，家电等领域。具有近 50 年微动开关生产经验，认证齐全。目前公司拥有 10 万级无尘车间和全自动，半自动开关生产设备 80 多套。年生产开关 1.8 亿只。800 多家客户包括华为，中兴，爱立信，比亚迪，东风，博世，Euro-Pro。我们以可靠的品质、优惠的价格、较短的供货周期，完善的服务作为承诺，欢迎国内外客商考察合作。

Our company (brand DONG HAI) specializes in the production of a full range of micro switches and other appliances switches for military, automotive, power tools, home appliances and other fields. With nearly 50 years of experience in the production of micro switches, the certification is complete. At present, the company has more than 80 sets of 100,000-level dust-free workshops and automatic and semi-automatic switch production equipment. The annual output of switches is 180 million. More than 800 customers include Huawei, ZTE, Ericsson, BYD, Dongfeng, Bosch, Euro-Pro. We take reliable quality, favorable price, short supply cycle and perfect service as our commitment, and welcome domestic and foreign merchants to investigate and cooperate.

#### 主要展品 / Products

专业生产全系列微动开关等器具开关用于军工，汽车，电动工具，家电等领域

A full range of micro switches and other appliances switches for military, automotive, power tools, home appliances and other fields.



#### 宁波简洁日化有限公司

#### NINGBO JIANJIE DAILY & COSMETICS CO., LTD

E3-3B25 3B26

地址：浙江省慈溪市观海卫镇东工业园区通业路18号(315315)

Add: 18 Tong Ye Road, East Industrial Zone, Guanhaiwei Town, Cixi City,

Zhejiang Province, China

电话 /Tel: 18868910808

传真 /Fax: 0574-63661650

网址 /Web: www.nbjianjie.com

宁波简洁日化有限公司，位于对外开放的重点城市，宁波市 50 公里 -- 慈溪市观海卫镇。公司拥有世界先进的牙刷生产设备和数条具有世界先进水平专业生产线的企业。本公司热忱欢迎国内外新老客户光临惠顾，携手合作，共创辉煌！

NINGBO JIANJIE DAILY & COSMETICS CO., LTD is located in Guanhaiwei, Cixi, which is only 50 kilometers away from Ningbo. The company has world advanced toothbrush production equipment and several enterprises with world advanced professional production lines. We warmly welcome new and old customers to visit and we can join hands to cooperate for the development and prosperity!

#### 主要展品 / Products

电动牙刷，洗鞋器，洗牙器

Electric toothbrush, shoe washer, oral irrigator



#### 宁波杰世米电器有限公司

#### NINGBO JASMINE ELECTRICAL APPLIANCE CO., LTD

W5-5C63

地址：浙江省余姚市朗霞街道杨家村创业北路3号(315480)

Add: Chuangye North Road, No.3, Yangjia Village, Langxia Street, Yuyao City, Zhejiang Province

电话 /Tel: 15968498760

网址 /Web: www.nbjasmine.com

宁波杰世米电器有限公司成立于 1995 年，是一家专业生产毛球修剪器的企业。公司目前拥有 150 名员工，重点致力于研发新品，并保证批量生产产品的稳定性，各产品系列得到了国内外客人的高度评价，目前为多个国际顶尖品牌代工。公司秉承“质量稳定，市场信赖，追求卓越，顾客满意”的质量方针，积极贯彻实施 ISO9001 标准，致力于提供更优质的服务和产品。

Ningbo Jasmine Electrical Appliance Co., LTD was established in 1995. We are located in Yuyao, with convenient transportation access to Ningbo and Shanghai Port. We are specialized in manufacturing lint remover and personal care products for more than 20 years. In terms of overseas market, we have OEM and ODM customers including Philips, SEB Group, Panasonic, Aldi, Kaufland, etc. So far, Jasmine has approx. 150 employees through six main departments. Accordingly, we have 5 in-house R&D employees, which enhance us with a prompt and flexible design changing. Meanwhile, 15 high quality QC enable all products range in Jasmine comply with customers' requirements. We also cooperate with International test lab such as SGS, BV, TUV, Dekra to ensure all products comply with International quality standards, including CB, CE, EMC, LVD, ROHS, REACH, SCCP, PAHs, etc. We are looking forward to establish promising business relationships with new clients around the world in the future.

#### 主要展品 / Products

毛球修剪器，刷鞋器

Lint Remover, Shoe Cleaner

**JMSON 嘉美臣****宁波洁嘉电器科技有限公司****Ningbo Jiejia Electronics Technology Co., LTD****E1-1B01**

地址: 浙江省余姚市双河路 765 号 (315400)

Add: No.765, Shuanghe Road, Fengshan Street, Yuyao, Ningbo, Zhejiang, China

电话 /Tel: 86-0574-62278010

传真 /Fax: 86-0574-62278010

网址 /Web: shop13857q3t500q0.1688.com

宁波洁嘉电器科技有限公司是一家专业吸尘器制造商。依托资深的技术研发实力,可靠稳定的产品质量,高效、诚信的服务理念来服务客户。作为吸尘器行业的新兴企业,我们将积极探索市场需求,提升产品质量与品质,热切希望与各方客户合作,共同开发市场,共同成长。

Ningbo jiejia electric technology co., LTD is a professional vacuum cleaner manufacturer. Relying on senior technical research and development strength, reliable and stable product quality, high efficiency, integrity of the service concept to serve customers. As a new enterprise in vacuum cleaner industry, we will actively explore market demand, improve product quality and quality, eager to cooperate with all customers, jointly develop the market, and grow together.

**主要展品 /Products**

家用吸尘器及家用清洁器具研发及制造

Household vacuum cleaner and household cleaning equipment development and manufacturing

**宁波洁匠智能科技有限公司****NINGBO JIEJIANG INTELLIGENT TECHNOLOGY CO., LTD.****E1-1B05**

地址: 浙江省宁波市余姚市银翔路 5 号 (315400)

Add: No.5 Yinxiang Road, Dongjiao Industrial Area, Yuyao City, Zhejiang Province, China

电话 /Tel: 15857468786

我们工厂成立于 2017 年, 位于风景如画的海滨城市余姚。

我们专注于吸尘器和除螨仪的研发。我们所有的产品都已通过 CE / GS / EMC / UL / CCC。我们的产品不仅在国内很受欢迎, 而且还远销十多个国家, 去年产量超过 50 多万台。

为了跟上时代的步伐, 进一步提升综合竞争力, 我司先后通过了质量体系认证, 如 ISO9001 等。此外, 我司有强大的技术团队可以更好的为客户提供服务。

Ningbo Jiejiang Intelligent Co., Ltd. established in 2017 and located in the picturesque coast city Yuyao.

We specially focus on new research and development of vacuum cleaner and dust mite controller. All our products have been approved by CE/GS/EMC/UL/CCC. Our produce very popular in domestic marker, exported to more than 10 countries, manufacture more than 500000pcs last year.

In order to meet worldwide challenges and further enhance our comprehensive competition ability, our company successively passed quality certification systems, such as ISO9001 and so on. Additionally, we have a strong technical support and a board development space that could

provide customers with better.

**主要展品 /Products**

吸尘器, 电动拖把, 除螨仪, 洗地机等各类清洁用品

vacuum cleaner, electric mop, dust mite controller and washing machines and so on

**宁波巨江电器有限公司****Ningbo Jujiang Electric Appliance Co., Ltd.****N2-2A31 2A32**

地址: 浙江宁波慈溪市观海卫镇狮桥盛昭路 32 号

Add: No. 32, Shengzhao road, Shiqiao, Guanhaiwei town, Ningbo, Zhejiang

电话 /Tel: 0574-63863726

网址 /Web: www.jujiangdianqi.com

宁波巨江电器有限公司(慈溪市湘湘电器)成立于 2014 年, 拥有 8 年终端热水研发并生产的经验, CCTV 央视上榜品牌, 央视战略合作伙伴。本公司集安全快速电热水龙头、变频即热式恒温小厨宝(热水器), 接驳式水龙头加热器、净水龙头等家电产品的研发、生产及销售为一体的家电制造企业, 我公司生产的系列家电产品不仅畅销于国内市场, 在国际市场上也受到热捧。热诚欢迎国内外有诚意的客户洽谈合作!

Founded in 2014, Ningbo Jujiang Electric Appliance Co., Ltd. (CIXI CITY Xiangxiang Electric Appliance Co., Ltd.) has 8 years of experience in Terminal Hot Water Development and production. CCTV is a brand on CCTV's list and a strategic partner of CCTV. Our company is an electrical appliance manufacturer integrating the R & D, production and sales of electrical appliance products such as safe and fast electric faucets, variable frequency instantaneous thermostatic small kitchen appliances (water heaters), feeder faucet heaters, water purification faucets, etc., our company produces a series of household appliances products not only sell well in the domestic market, in the international market is also popular. We sincerely welcome customers at home and abroad to negotiate cooperation!

**主要展品 /Products**

集安全快速电热水龙头、变频即热式恒温小厨宝(热水器), 接驳式水龙头加热器、净水龙头等家电产品

SET SAFE and Fast Electric Water Faucet, frequency conversion instantaneous thermostatic small kitchen treasure (water heater), connected to the faucet heater, water purification faucet and other appliances

**Calla 开乐****宁波开乐电机有限公司  
Ningbo Calla Motor Co., Ltd.****N1-1A08**

地址: 宁波杭州湾新区滨海三路 16 号 (315336)  
Add: 16 Binhai 3rd Road, Hangzhou Bay New District, Ningbo  
电话 /Tel: 0574-63905115  
传真 /Fax: 0574-63905115  
网址 /Web: <https://en.callagroup.com.cn/>

宁波开乐电机有限公司占地面积 120 亩, 建筑面积达 6 万平方米, 总投资 3.2 亿人民币。公司专业生产各种电机和电动推杆, 年产量分别达到 800 万套和 500 万台。

公司通过 ISO9001-2015 质量管理体系认证, CCC 认证、德国 TUV 认证、欧盟 CE 认证和美国 UL 认证。

The company covers an area of 120 acres, with a construction area of 60,000 square meters and a total investment of 320 million yuan. The company specializes in the production of various motors and electric actuators, with an annual output of 8 million sets and 5 million sets respectively.

The company has passed ISO9001-2015 quality management system certification, CCC certification, German TUV certification, EU CE certification and American UL certification.

**主要展品 /Products**

家用电机 / 灯具燃烧器 / 电动推杆 / 新风系统  
Electric Motor/Burner/Linear Actuator/Fresh Air System

**宁波凯迪利电器有限公司  
Ningbo Kedly Appliance Industry Co., Ltd.****E2-2B03**

地址: 浙江省慈溪市横河镇梅湖路 31 号 (315318)  
Add: No.31 Meihu Road, Henghe Town, Cixi, China  
电话 /Tel: 0574-58997798  
传真 /Fax: 05474-58990596

宁波凯迪利电器有限公司位于中国慈溪市, 成立于 2001 年, 一家专门致力于厨房小家电的研发, 生产和出口。公司经过 20 余年发展, 占地面积达 7 万平方米和拥有 120 台注塑机, 25 条生产线和 800 多个工人, 年销售额达 4 亿多人民币。公司秉承“质量为本”的生产信念, 产品远销 60 多个国家, 主要产品类别: 柳橙机, 榨汁机, 磨豆咖啡机, 打蛋机和绞肉机, 可以提供 ODM 和 OEM 服务。诚邀国内外广大客商来公司参观。

Ningbo Kedly electric Appliance Co., Ltd. is located in Cixi city, China, founded in 2001, a specialized kitchen appliances company. After more than 20 years of development, the company covers an area of 70,000 square meters and has 120 injection molding machines, 25 production lines and more than 800 workers, the annual sales of more than 400 million dollar. Adhering to the production belief of "quality first", the company's products are exported to more than 60 countries, the main product categories: orange machine, juice machine, bean coffee machine, egg beater and meat grinder, can provide ODM and OEM services. Through years of efforts and industry

reputation, company has reached strategic cooperation agreements with well-known brand customers at home and abroad. We sincerely invite customers from home and abroad to visit our company.

**主要展品 /Products**

榨汁机, 咖啡机, 绞肉机, 柳橙机, 刨冰机等  
coffee maker, centrifugal juicer, meatgrinders, citrus juicer, ice crushers.

**宁波康茂智能科技有限公司  
Ningbo Konmo Intelligent Technology Co., Ltd.****N3-3B53 3B54**

地址: 浙江省宁波市余姚市磨刀桥路 96 号 (315400)  
Add: No. 96, Modaoqiao Road, South Zone Of Economic Development Zone, Yuyao,  
Ningbo, Zhejiang, China  
电话 /Tel: 0574-62887988  
传真 /Fax: 0574-62887988  
网址 /Web: [www.konmo.com.cn](http://www.konmo.com.cn)

宁波康茂智能科技有限公司位于浙江省第二大城市—宁波, 成立于 2016 年 7 月, 注册资金一千万, 年产值四千万, 员工 50 余人。我们是一家以咖啡机开发为主导, 集生产设计、加工、经销批发为一体, 专注于生产销售胶囊咖啡机、奶泡机、咖啡胶囊、咖啡器具等系列产品。公司拥有一批高级工程技术人才, 具有较强的软、硬件、结构设计开发及生产能力, 我们坚持以客户为本、以信用为先的服务准则, 以优质的产品去赢得更多客户的信赖!

Ningbo KONMO Intelligent Technology Co., Ltd was established in 2016 and is located in Ningbo, China.

We are professional specialized in manufacture of small household appliances for more than 4 years. Our company has excellent team with rich experience in the research, development, quality control, inspection, sale, service and company running. Our main products include coffee machine, milk frother, automatic sensor liquid soap dispenser etc. which are exported to countries all over the world. Besides, we are making great efforts to develop new products to meet different requirements. Our company has professional equipments to strictly control the product quality. In addition, we also have obtained CE, GS, CB, ROHS, ERP, UL certificates for our products. We warmly welcome customers from at home and abroad to cooperate with us on OEM and ODM order for common success whether selecting a current product from our catalog or seeking engineering assistance for your application.

**主要展品 /Products**

胶囊咖啡机、奶泡机、烘豆机、磨豆机、咖啡胶囊、咖啡器具等。  
Coffee machine, milk frother, coffee grinder, hand coffee cup.

GOODSKY

科立·电器

**宁波科立电器有限公司****Ningbo Keli Electric Appliance Co., LTD****E3-3B03**

地址: 宁波鄞州区茅山工业区邦星路 88 号 (315191)

Add: 88 Bangxing Road, Maoshan Industrial Zone, Yinzhou District, Ningbo

电话 /Tel: 0574-83011807

传真 /Fax: 0574-83011807

网址 /Web: 88 Bangxing Road, Maoshan Industrial Zone, Yinzhou District, Ningbo

宁波科立电器是一家拥有设计、研发、生产、销售等能力的个护电器综合服务厂商。面向全球品牌商、渠道商提供一站式 OEM/ODM 合作。我们拥有 10 年以上制造经验和完整管理经验。主要产品: 理发器、电动牙刷、美容仪。我们始终坚持以科学创新, 品质优先的生产理念, 规范的生产流程, 严谨的品控流程, 秉承客户至上的核心理念, 积极发挥设计、研发、制造优势, 携手优秀的合作伙伴, 为全球品牌提供高颜值、高品质、高性价比的个护产品。

We, Ningbo Goodsky Electrical Appliances Co., Ltd, are a comprehensive service manufacturer with design, research and development, production, sales and other capabilities. Provide one-stop OEM/ODM cooperation for global brands and channels. We have more than 10 years of manufacturing experience and management experience. Our main products include: hair clipper, electric toothbrush, beauty instrument.

We always adhere to the scientific innovation, quality first production concept. And strictly comply with the standard production process and rigorous quality control process.

Adhering to the core concept of customer first, we actively play the design, research and development, manufacturing advantages and eager to meet excellent partners, in the world to provide high appearance level, high recognition, high quality, cost-effective personal care products.

**主要展品 /Products**

电推剪、女士剃毛器、铲皮机、黑头仪、导入仪、筋膜枪、除湿机、婴儿吸鼻器、磨脚器

Main exhibits: electric scissors, lady shaving machine, skin scraper, blackhead instrument, introduction instrument, fascia gun, dehumidifier, baby nasal suction device, foot grinding device.

Cerlffol

**宁波克虏伯电器有限公司****Ningbo KeLuBo ELECTRICAL APPLIANCE CO.,LTD****E1-1B10**

地址: 浙江省宁波市慈溪市周巷镇企业东路 498 号 (315324)

Add: No. 498, enterprise East Road, Zhouxiang Town, Cixi City, Zhejiang Province

电话 /Tel: 13567492668

传真 /Fax: 0574-5330661

网址 /Web: www.cerlffol.com

认真 专注 责任 一直是我们宁波克虏伯电器有限公司所秉承和坚守的信念。宁波克虏伯电器有限公司拥有 2 个厂区共 5500 平方米, 配备有 6 条现代化自动装配流水线, 注塑车间和配件仓库以及成

品仓库各一个。管理团队配备人员齐全, 始终以做专, 做精, 做好为己任, 专心企业精细化品牌服务并以卓越的产品和真诚耐心的服务, 为客户不断创造价值! 是的, 我们一直在努力做得更好, 这就是克虏伯,

welcome

Carefulness, focus and responsibility has always been Ningbo Krupp Electrical Appliance's vision. Careful: There is nothing in the world that could beat carefulness. Krupp is careful about every product research and development, product testings, production processes, sales orders and customers. Focus: Krupp is not distracted by outside temptation, and stays focused on electrical heating, ironing machine and steamer industry. Krupp is concentrating on our own products. Responsibility: Responsibility is one of the most important company culture in Krupp. Krupp deeply believes that the employees, the company and our customers belong to a community of shared future.

Ningbo Krupp Electrical Appliance Co., Ltd has 2 manufacturing plants and 5500 m2 area in total, including 6 modernised automatic assembly line, injection moulding shop, parts warehouse and finished product warehouse. The company is well organised and managed.

Krupp, always striving for better!

**主要展品 /Products**

手持蒸汽刷 / 蒸汽小熨斗 / 电熨斗 / 挂烫机 / 毛球修剪器

Hand held steam brush / small steam iron / electric iron / hanging ironing machine / hair removal machine

KUNLING

**宁波昆凌智能科技有限公司****E2-2B15**

地址: 浙江省余姚市低塘街道汤家闸村唐家 128 号 (315400)

电话 /Tel: 0574-62222208

传真 /Fax: 0574-62222208

网址 /Web: <https://kunlingzhineng.en.alibaba.com/>

宁波昆凌智能科技有限公司专业从事研发、生产和销售挂烫机、除螨仪及电动拖把等家用电器系列产品。经过前期的建设和发展, 形成了规模化的挂烫机和除螨仪产品生产基地和外贸出口产品生产基地, 昆凌已成为浙江地区挂烫机、除螨仪行业最具影响力的企业之一。

Ningbo Kunling Zhineng Technology Co., Ltd. Founded in 2020, is a manufacturer who specialized in the research, development, production and sales of household appliances. We have garment steamer, UV mite vacuum cleaner, handheld vacuum cleaner and electric mop. Located in Yuyao, Ningbo China, our company now covers 10,000 square meters, owns more than ten production lines, with annual production capacity of 1,500,000 sets. Our company is well equipped with advanced electrical laboratories of garment steamer and vacuum cleaner. Our company has passed the ISO9001:2015 quality management system certification, BSCI and SGS quality certification, and most of our models have passed CB, CE, ROHS and etc. We have many well-known oversea partners. Domestically, our company have achieved long-term strategic cooperations with Haier and Supor, two of the most famous Chinese home appliance companies, we jointly develop new models according to market trend.

**主要展品 /Products**

除螨仪, 电动拖把, 挂烫机

UV Vacuum Cleaner, Electric Mop, Garment Steamer





### 宁波莱可家居用品有限公司

#### Ningbo Laike household products Co., Ltd.

地址: 浙江省慈溪市观海卫镇昭十三房工业区 (315314)

Add: Zhaoshisanfang Industrial Zone, Guanhaiwei town, Cixi City, Zhejiang Province

电话 /Tel: 0574-63651825

传真 /Fax: 0574-63651825

网址 /Web: <http://www.star169.com/2020/laike/cn/>

莱可家居一直专注智能口腔护理产品的研发、生产, 致力于满足人们追求高效、便捷、健康的生活理念, 秉承与社会前沿科技接轨的思想, 紧跟时代步伐, 不断用新的潮流思想冲击我们的产品研发, 为开发新产品注入新鲜活力。

Laike home has been focusing on the R & D and production of intelligent oral care products. It is committed to meeting people's pursuit of efficient, convenient and healthy life. Adhering to the idea of integrating with social cutting-edge science and technology, it keeps up with the pace of the times, constantly impacts our product R & D with new trend ideas, and injects fresh vitality into the development of new products.

#### 主要展品 /Products

我们是一家集生产与加工为一体的制造型企业, 拥有高速植毛机、高速异型机、异型机、切磨毛机、刷头包装机及周边设备; 拥有电动牙刷专业生产线、热封包装机, 同时配备专业的检测仪器以满足生产需求。专业的技术顾问来解决产品研发及生产中的各种问题, 并有专业的技术人员进行产品试行及生产, 以保证产品质量。

We are a manufacturing enterprise integrating production and processing, with high-speed hair planting machine, high-speed special-shaped machine, special-shaped machine, hair cutting and grinding machine, brush head packaging machine and peripheral equip



### 宁波莱悦电器有限公司

#### Ningbo Laiyue Electric Appliance Co., Ltd.

地址: 宁波杭州湾新区庵东镇富民村崔陈路 241 号 (315327)

Add: No.241 Cuichen Road, Fumin Villiage, Andong Town, Hangzhou Bay New District

Ningbo, Zhejiang

电话 /Tel: 18906742812

传真 /Fax: 0574-63475715

网址 /Web: <https://shop76082fg59g484.1688.com>

宁波莱悦电器有限公司位于杭州湾南岸杭州湾新区是洗衣机、迷你洗衣机、洗袜子机、内衣护理机、便携式洗衣机等产品专业生产加工的公司, 拥有完整、科学的质量管理体系, 产品通过 CCC、GS、CE、ETL 认证。宁波莱悦电器有限公司的诚信、实力和产品质量获得业界的认可。欢迎各界朋友莅临参观、指导和业务洽谈。

E3-3A41 3A42

W3-3H76

Ningbo Laiyue Electric Appliance Co., Ltd. is located in Hangzhou Bay New District which is on the South bank of Hangzhou Bay. Our company focuses on development and manufacturing of washing machine, mini washing machine, socks washing machine, underwear care machine, portable washing machine etc., and has a complete and scientific quality management system. Our products are certified by CCC, GS, CE, ETL etc. Our integrity, strength and product quality are recognized by the industry. Welcome friends from all fields to visit, guidance and business negotiations.

#### 主要展品 /Products

洗衣机、迷你洗衣机、洗袜子机、内衣护理机、便携式洗衣机等产品

manufacturing of washing machine, mini washing machine, socks washing machine, underwear care machine, portable washing machine etc.

## LOFANS

### 宁波朗菲生活电器有限公司

#### Ningbo Lofans Home Appliance Co., Ltd.

E3-3E11-1

地址: 浙江省慈溪市白沙路街道浪木大厦 <22-3> 室 (315300)

Add: Room 22-3, Langmu Building, Baisha Road, Cixi City, Zhejiang Province, China

电话 /Tel: 400-812-7887

传真 /Fax: 0574-63082780

网址 /Web: <http://www.lofans.com.cn>

朗菲电器 LOFANS 成立于 2018 年, 是一家集供应链制造、研发、技术、品牌、销售于一体, 致力于开发日用创意生活小电器的公司。2019 年加入小米生态链, 在衣物熨烫、清洁护理、创意生活小家电领域具备设计、研发、制造、营销的领先能力。

朗菲坚持以用户需求为导向, 用心打磨好产品, 改善生活品质为核心, 致力于研发高品质、高颜值、高工艺和高性能的“四高”产品, 努力为追求高品质生活的用户提供优质的产品和服务。

LOFANS, founded in 2018, is a company that integrates supply chain manufacturing, R&D, technology, branding and sales, and is committed to the development of daily creative small electrical appliances. We joined the Xiaomi Ecological Chain in 2019 and have leading capabilities in design, R&D, manufacturing and marketing in the fields of clothing ironing, cleaning and care, and small home appliances for creative life.

LOFANS adheres to the user's needs as the guide, carefully polishes the products, and improves the quality of life as the core. product and service.

#### 主要展品 /Products

衣物熨烫、清洁护理、创意生活小家电。

Clothes ironing, cleaning care, creative life small appliances



LUCKBOIL®  
DRINK EASILY ENJOY YOUR LIFE

**宁波乐开宝电器有限公司**  
**LUCKBOIL**

**W2-2D51**

地址: 宁波乐开宝电器有限公司 (315500)  
电话 /Tel: 17757073177  
网址 /Web: www.luckboil.com

乐开宝电器于 2014 年成立, 位于美丽的宁波方桥工业园区, 公司通过全资并购、控股、合作等方式集合水家电领域以成熟的技术和完善的销售渠道, 集产品研发、生产、营销于一体的高科技企业。营销模式不断创新和优化, 用线上多元化、线下多渠道和 oem\odm 建立全覆盖式的立体化市场营销。公司拥有多项国家发明、实用性、外观等专利, 依托方桥基地强大的研发团队和生产基地, 产品在市场一直深受顾客好评。

**主要展品 /Products**

即热式壁挂管线机



LIMIKA  
LIFE FLAVOUR CREATOR

**宁波乐美佳电器科技有限公司**  
**Ningbo Lemeijia Electric Equipment Technology Co.,Ltd**

**W2-2B30 2B31**

地址: 浙江省宁波市慈溪逍林大道 1819 号 (315000)  
电话 /Tel: 0574-63931087  
传真 /Fax: 0574-63931087  
网址 /Web: https://limika.en.alibaba.com/

宁波乐美佳电器科技有限公司座落在我国最大的家电生产基地--浙江慈溪。目前所研发的产品有: 空气净化器、空气炸锅两大系列。是一家集研发、设计、生产、销售、服务于一体的健康家电生产型企业。主打健康、环保的居家生活理念。

**主要展品 /Products**

空气炸锅



LESLEI 乐士

**宁波乐士实业有限公司**  
**Ningbo Lesli Group Co.,LTD**

**W1-1A01**

地址: 中国浙江省宁波市鄞州区鄞县大道东吴段 68 号  
电话 /Tel: 0574-88356276  
传真 /Fax: 0574-88355526  
网址 /Web: WWW.lesligroup.com

创立于 1993 年的宁波乐士实业有限公司, 是涉及烘干机和洗衣机等领域的专业化、现代化企业集团。

公司年生产能力, 烘干机 50 万台, 洗衣机 100 万台, 洗衣机散件 80 万台, 远销海内外七十多个国家。同时与沃尔玛、伊莱克斯、TCL、松下、VESTEL、澳柯玛等多个知名企业合作。

企业致力于往精益化、专业化的方向发展, 已成为国内最专业的洗衣机、烘干机制造企业。

Founded in 1993, Ningbo Lesli Industry Co., Ltd is a specialization and modernization enterprise that involved in Clothes Dryers, Washing Machines and other fields.

· Company annual production capability, 500,000 pcs for Clothes Dryer, 1,000,000 pcs for Washing Machines, 800,000 sets for Washing machine CKD. Lesli products sell all over the world and has successfully entered into more than 70 countries. Meanwhile Lesli is cooperating with many international brands like Wal-Mart, Electrolux, TCL, Panasonic, VESTEL and AUCMA.  
· Lesli is committed to the development of specialization and professional, and has become the most professional washing machine and clothes dryer manufacturer in China.  
· The company's own brand "LESLEI" 阿卡特 ACANTHASTER

**主要展品 /Products**

阿卡特烘干机使用效果是很好的, 非常智能。这款烘干机融合了前沿的触控科技, 多种烘干模式能够适应不同的情况, 时尚大气的触摸屏只需要轻轻一按, 就能够选择自己所需要的模式, 有特干、普通、冷风多种模式轻松选择, 贴心方便。另外, 时间调整也非常便利, 能够根据自身的需求来调整烘干的时间, 还具有预约时间、定时启动的功能, 非常的人性化。最重要的是还采用了黄金巴氏消毒法, 黄金 65 度烘干衣物, 从而杀灭一些细菌。



**宁波联合众投供应链管理有限公司**

**N4-4C01**

地址: 浙江省慈溪市古塘街道智慧谷科技广场 1 号楼 401-406 (315300)  
电话 /Tel: 0574-63588200  
传真 /Fax: 0574-63588200

Speed Queen 速比坤的座右铭是“更好的质量, 造就更长的寿命 (Built Better, to Last Longer.)”, Speed Queen 速比坤洗衣设备针对商用设计, 在所有家用型号中也采用了同样的技术和商用级部件。长达 25 年的使用寿命及 5 年的超长保修, 让我们的设备持久耐用。

**主要展品 /Products**

滚筒洗衣机, 烘干机, 叠压机



**宁波灵鸣达电器有限公司**  
**Ningbo Lingmingdo Electric Appliance CO.,LTD**

**N1-1B31 1A32**

地址: 浙江省余姚市东旱门路 188 号 (315400)  
Add: No.188 Donghanmen Road, Lizhou Street, Yuyao City, Zhejiang Province, China  
电话 /Tel: 13736027766

宁波灵鸣达电器是一家专业从事厨房家电产品研发, 生产, 销售为一体的规模型责任有限公司, 公司主要生产产品有: 空气炸锅, 咖啡机, 果汁机, 吸尘器。公司具有一流的生产设备、精湛的工艺技术, 公司拥有 3C, CE, ROHS, CB, ETL 等证书, 产品在国内市场畅销, 出口欧洲, 美日韩等国。

Ningbo Lingmingdo electric appliances Co., LTD is a professional engaged in kitchen appliances research and development, production, sales as one of the company.

The main products of the company are: air fryer, coffee machine, juice machine, vacuum cleaner,

etc. The company has first-class production equipment, exquisite technology, the company has 3C, CE, ROHS, CB, ETL certificates, products in the domestic market best-selling, exported to Europe, the United States, Japan and South Korea and other countries.

#### 主要展品 /Products

空气炸锅, 咖啡机, 果汁机, 吸尘器, 制冰机, 三明治机, 烤面包机等

Air fryer, Coffee Machine, Juicer & Blender, Vacuum Cleaner, Ice Maker, Sandwich Maker, Toaster, etc



#### 宁波绿森林电子科技有限公司

#### NINGBO GREEN FOREST ELECTRONIC TECHNOLOGY CO., LTD

E2-2C76

地址: 浙江省余姚市泗门镇长振路7号 (315400)

Add: NO.7 CHANGZHEN ROAD SIMEN TOWN YUYAO CITY ZHEJIANG CHINA

电话 /Tel: 0574-62179107

传真 /Fax: 0574-62179115

网址 /Web: <http://www.cngforest.com>

宁波绿森林电子科技有限公司是一家集产品设计开发、生产和营销服务为一体的小家电制造企业, 具有独立法人资格和自营进出口权的有限责任公司。公司生产的加湿器, 风扇在国内国际享有较高的影响。

公司以“质量第一, 诚信为本”的经营方针, 专业生产加湿器、风扇、吸尘器 etc 家用电器系列产品, 并有自主研发, 自主检测能力, 确保产品符合 ROHS 环境保护要求。确保产品能保质、保量、保时间的交货。

Ningbo Green Forest Electronic Technology Co., Ltd mainly specialized in designing, manufacturing and marketing household electrical appliance. The humidifier and fan produced by the company enjoy high influence at home and abroad

As our operation guideline “quality first, integrity-based. Specializing in the production of humidifier, fan, vacuum cleaner and other household appliances. It also has independent research and development and independent testing ability to ensure that the products meet ROHS environmental protection requirements. Ensure that the products can be delivered with quality, quantity and time.

#### 主要展品 /Products

电风扇、吸尘器、烘干机

FAN, VACUUM CLEANER, CLOTHES DRYER



#### 宁波绿之品电器科技有限公司

#### NINGBO LVZHIPIN ELECTRICAL APPLIANCE SCIENCE AND TECHNOLOGY CO., LTD.

W3-3D116

地址: 浙江省余姚市经济开发区南区凤仪路66号

电话 /Tel: 0574-62522222

绿之品科技有限公司成立于2012年, 公司位于浙江省宁波市, 是一家专注于绿色健康电器(咖啡机, 即热饮水机, 洗牙器等口腔设备…)的设计研发、生产和销售的现代化企业。公司拥有自己的工业设计中心, 研发中心, 测试实验室和生产基地。产品覆盖全国30多个省、市、自治区, 并远销日本、美国、欧盟等国家和地区。

Grenp Science and Technology Co. Ltd established in 2012, the company is located in Ningbo city of Zhejiang, which are focus on green healthy product development (Coffee maker, hot dispenser and water pick, etc.). We have our own industry design center, product design & development center, test laboratory and manufacturing base. Our products are sold over 30 provinces of China as well as over world such as Japan, USA, and Europe countries.

#### 主要展品 /Products

胶囊咖啡机、即热饮水机、洗牙器

Coffee maker, hot dispenser and water pick



#### 宁波迈臣科技有限公司

#### FAGOR.S.COOP

N3-3H51

地址: 浙江省宁波市江北区长兴路715号恒凯大厦8楼801-805 (315033)

Add: 801-805, 8th Floor, Hengkai Building, 715 Changxing Road, Jiangbei District, Ningbo city

电话 /Tel: 0574-88398272

传真 /Fax: 0574-88398272

网址 /Web: <https://www.fagor-sda.com/>

FAGOR 品牌于1943年由一位著名的牧师牵头, 联合五位创始人在西班牙与法国交界处的蒙德拉贡市成立。不仅是西班牙白色家电唯一的全球性制造商, 更是欧洲五大家电制造商之一。以其卓越的创新力享誉世界, 产品销往全球130个国家, 在全球拥有30个加工厂。FAGOR作为西班牙国宝级品牌, 多次被西班牙国王授予勋章, 其各类产品为全球数百万的家庭提供舒适优质的服务。

FAGOR was founded in 1943 in the city of Mondragon, on the border between Spain and France, by five co-founders, led by a famous priest. Spain is not only the only global manufacturer of white goods, but also one of the top five manufacturers of home appliances in Europe. Its products are sold in 130 countries around the world and it has 30 processing plants worldwide. As a Spanish national treasure brand, FAGOR has been awarded MEDALS by the King of Spain for many times. Its various products provide comfortable and high-quality services for millions of families around the world.

#### 主要展品 /Products

厨房家电: 空气炸锅、便携式电热水杯、多功能料理机、空气炸烤箱、养生壶、蒸烤一体机等;

生活家电: 空气除湿机、手持吸尘器、无线布艺清洁机、除螨吸尘器、便携干衣胶囊、空气净化器等等。

Kitchen appliances: air fryer, portable electric water cup, multi-functional cooking machine, air fried oven, health pot, steam and bake all in one machine, etc.

Household appliances: air dehumidifier, hand-held vacuum cleaner, wireless cloth cleaner, mite cleaner, portable dry clothes capsule, air purifier, etc.

## MANHUA

曼华制造 全球分享

### 宁波曼华电器有限公司

#### Ningbo Manhua Electrical Appliances Co., LTD

N3-3B18

地址: 慈溪市横河镇横彭公路 228 号 (315318)

Add: No.228, Hengpeng Road, Henghe Town, Cixi, Ningbo, China

电话 /Tel: 86-574-63250852

传真 /Fax: 86-574-63250852

网址 /Web: <https://nbmanhua.en.alibaba.com/>

宁波曼华电器有限公司经过多年的积累和发展, 现有占地面积 10 万平方米, 建筑面积 6 万平方米, 员工 2000 人。拥有一批高级技术人员和一流的模具加工设备、先进的注塑机械、厨房电器流水线等。是一家集产品设计、开发、生产和服务于一体的工贸企业吗。

Ningbo Manhua Electrical Appliances Co., Ltd. after many years of accumulation and development, the existing covers an area of 100000 square meters, building area of 60000 square meters and 2000 workers. Has a number of senior technical personnel and first-class tooling processing equipment, advanced injection molding machinery, kitchen appliances such as assembly lines. Is a collection of product design, development, production and service of integrated industry and trade enterprises

#### 主要展品 /Products

空气炸锅

air fryer

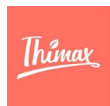

### 宁波美博力特电器有限公司

#### Ningbo Amberade Electric Appliance Co., Ltd

E2-2E81

地址: 宁波市北仑区新碶大港六路 77 号 (315800)

Add: No. 77, Dagang 6th Road, Beilun District, Ningbo

电话 /Tel: 0574-86810088

传真 /Fax: 0574-86810088

网址 /Web: [www.thimax.com.cn](http://www.thimax.com.cn)

膳美师, 隶属于美国赛美思股份有限公司的高端厨电品牌, 定位于“高端品质, 优雅新厨”。

2020 年, 膳美师整合全球优质研发及设计资源, 最先以美国牛排机专家的品牌形象登陆中国, 并做到细分市场第一, 之后专注创新, 陆续推出高速破壁机、立体厨师机、多功能打蛋器、空气炸锅等专

业级厨电产品解决方案, 持续升级焕新厨房生活方式。

膳美师相信, 唯有精良的厨房烹饪工具, 才能开启更美妙的烹饪灵感。

Thimax belongs to Thimax Inc. USA, which is a global premium kitchen appliance brand. Its aim is to achieve high quality, produce elegant and creative kitchen appliances.

In 2020, Thimax integrated the excellent R&D and design resources in the world and appeared in China first as an America brand of contact grill expert. It obtained the No.1 market share in this area. Thimax concentrate on creation and brought high speed blender, vertical kitchen machine, multifunctional hand mixer, air fryer and other professional kitchen appliances to the market, which continuously leads to the upgrade of kitchen lifestyle.

Thimax believes that only excellent kitchen appliances can stimulate a far better cooking inspiration. In future, Thimax wishes to produce premium kitchen appliances which takes into design aesthetics and functionalism from a more prospective view.

This enables the high end consumers to have an elegant lifestyle while using Thimax products.

#### 主要展品 /Products

·膳美师智能感温牛排机 HRG1013

·膳美师高端牛排机 HRG1018A

·膳美师高速破壁机 BL3332

·膳美师立体厨师机 FP7728

·膳美师多功能打蛋器 HM1135

·膳美师手持搅拌棒 HB2236B

·膳美师土锅压力电饭煲 EPC6303

·膳美师空气炸锅 AF9217

·膳美师水光米饭电饭煲 EPC6301

·膳美师食品加工机 MC4429

·Thimax smart temperature control contact grill HRG1013

·Thimax Premium contact grill HRG1018A

·Thimax High Speed Power Blender BL3332

·Thimax Food Processor FP7728

·Thimax Multi-functional Hand Mixer HM1135

·Thimax Hand Blender HB2236B

·Thimax IH Pressure Rice Cooker with clay pot EPC6303

·Thimax Air fryer AF9217

·Thimax IH Pressure Rice Cooker EPC6301

·Thimax Food Processing Machine MC4429



厨房清洗方案服务商

### 宁波美高厨具有限公司

#### Ningbo Mengo Kitchen Equipm

N2-2G91

地址: 浙江宁波海曙区古林三星工业区

电话 /Tel: 4001130190

网址 /Web: [www.torva.cn](http://www.torva.cn)

宁波美高厨具有限公司, 成立于 2017 年, 是小米洗碗机生态链企业。

美高专注模块化集合的新生态厨房清洗领域, 专注清洗消杀技术, 目前拥有专利共超 350 项, 囊括了红点奖、金点奖和当代好设计奖, 也是《家用和类似用途集成式洗碗机》标准制定者。



旗下品牌 TORVA 拓屋, 针对品质生活人群, 主打智能解放双手的厨房清洗产品, 从智能果蔬清洗机到集成模块化的集成水槽, 始终秉持以人为本, 旨在创造一个自由健康厨房生活。

#### 主要展品 /Products

集成水槽、洗碗机、集成灶、各类厨房电器



#### 宁波美格斯特电器科技有限公司 NINGBO MEIGESITE ELECTRICAL TECH. CO., LTD

N3-3A46

地址: 浙江省余姚市余马路 2 号

电话 /Tel: 13336669837

公司成立于 2014 年, 位于浙江省宁波市余姚市。交通便利, 1-1.5 小时即可到达宁波栎社和杭州萧山机场。

公司拥有了一支致力于咖啡机设计研发、生产、品质控制、销售为一体的专业团队。面对强大的市场竞争压力,

我们的宗旨: 以质量求生存, 以价格求竞争力, 以市场薄利多销。

我们的理念: 客户的满意是我们不懈的追求。

我们真诚希望与世界各地的新老朋友发展和继续合作关系。

#### 主要展品 /Products

意式咖啡机

coffee machine



#### 宁波美煜电器有限公司 Ningbo Meiyu Electrical Appliance Co., Ltd.

W1-1B45

地址: 浙江省余姚市泗门镇姚北大道 1 号 (315470)

Add: Simen Town, Yuyao City, Ningbo, China

电话 /Tel: 057462166035

传真 /Fax: 057462160695

网址 /Web: www.nbmeiyu.com

宁波美煜电器有限公司是专业生产爆米花机、棉花糖机、冰淇淋机、空气炸锅、煮蛋器、切菜机、厨师机、早餐机的厂家。

公司注册资本 200 万, 占地面积 1.2 万平方米。我们有 20 名技术人员和 180 名工人。

我们供应的电器在欧美等地都有很好的市场, 获得国际认证, 国内已过 3C 认证。公司承接 OEM/ODM, 在新产品的设计和工程方面给予充分的协助, 提供高质量的产品给客户。

Ningbo Meiyu Electrical Appliance Co., Ltd. specialized in producing all kinds of popcorn machines. We have two million registered capital, 12 thousand square meters area. There are 20 technicians and 180 workers in our company. We supply popcorn machine and have a good market in the United States and Canada, South America, Europe, the United Kingdom, Asia, and

Australia. Our products have obtained international approvals, such as GS, CE, ETL, CB, etc. Ningbo Meiyu Electrical Appliance Co., Ltd. is capable of working closely with all customers to meet their popcorn machine specifications and give full assistance in the design and engineering of new products. Providing quality products upon demand is key to our performance.

#### 主要展品 /Products

专业生产爆米花机、棉花糖机、冰淇淋机、空气炸锅、煮蛋器、切菜机、厨师机、早餐机  
Specializing in the production of popcorn machine, cotton candy machine, ice cream machine, air fryer, boiled egg, vegetable cutter, cooks, breakfast machine



MBV 灭霸

#### 宁波灭霸康美科技有限公司 NINGBO MBV KANGMEI TECHNOLOGY CO., LTD

W2-2C71

地址: 浙江省余姚市兰江街道谭家岭西路 1228 号 (325400)

Add: No.1228 Tanjialing West Road, Zhejiang, China

电话 /Tel: 15067445072

网址 /Web: www.mbvair.com

宁波灭霸康美科技有限公司是浙江和惠照明科技有限公司旗下全资子公司 (简称 MBV), MBV 定位于健康电器领域; 首期推出的产品主要以环境健康消杀类产品为主 (包含空气消杀 & 空气净化)。

公司已获得消毒产品生产企业卫生许可证及医疗器械质量管理体系认证证书, 并且拥有自营进出口资质, 产品远销全球 10 多个国家以及地区。

Ningbo MBV Kangmei Technology Co., Ltd (MBV for short) is a wholly-owned subsidiary of Zhejiang Howell. Zhejiang Howell was focus on garden landscape lighting.

MBV is positioned in the field of healthy electrical appliances. The products launched in the first phase are mainly focus on environmental healthy disinfection products (Include UVC air disinfection and air purification).

The company has got the Sanitation license for disinfection products manufacturers, and has got the certificate of Medical device quality management system, with self-operated import and export qualification. Products are exported to more than 10 countries and regions.

#### 主要展品 /Products

首期推出的产品主要以环境健康消杀类产品为主, 主要包含空气消毒机, 空气净化器

The products launched in the first phase are mainly focus on environmental healthy disinfection products, include UVC air disinfectant and air purifier.



### 宁波铭瑞中兴电子科技有限公司

#### Ningbo Mingrui Zhongxing Electronic Technology Co., Ltd.

**W2-2B40**

地址: 宁波市鄞州区投资创业中心金辉西路 177 号 2 号楼 2 楼 (315105)

Add: NO.177 Jinhui West Road, Yinzhou Zone, Ningbo City, 315100, Zhejiang Province, China

电话 /Tel: 0574-87797488

传真 /Fax: 0574-87797272

网址 /Web: http://www.nbmrzx.cn/

宁波铭瑞中兴电子科技有限公司是致力于传感器、集中润滑、各类控制器等相关产品研发及制造的国家高新技术企业,产品广泛应用于家电、医疗设备、机械、电子、水泵、净水处理和汽车底盘集中润滑系统配套等各个领域,自 2007 年成立以来,已经获得 5 项发明专利、10 项实用新型、9 项外观专利、17 项软件著作权,并通过了 ISO9001 质量管理体系认证和 IATF16949 汽车质量管理体系认证。

Ningbo Mingrui Sensors Co.,LTD is a national high-tech enterprise committed to the research & development and manufacturer of sensors,centralized lubrication and various controllers.Our main products are all kinds of liquid level sensor,a non-contact sensors,proximity sensor,oil/water tank level sensor,flow sensor,photoelectric sensor,lubrication pump controller,automobile chassis lubrication controller,air/air purification controller,etc.,Our products are widely used in household appliances,medical equipment,machinery electronics,water pump,water purification processing and auto chassis centralized lubrication system and other fields.Customization and R&D can be made according to customer's requirements.

We have obtained 5 invention patents,10 utility model patents and 17 software copyrights through the unremitting efforts of the research and development team, and passed ISO9001 quality management system certification and IATF16949 automobile quality management system certification.

#### 主要展品 /Products

传感器、控制器、集中润滑

sensors, controllers, centralized lubrication

 MUBEN  
木本生活

### 宁波木本生活电器有限公司

#### Ningbo Muben Life Electric Appliance CO.,LTD.

**E1-1G71**

地址: 浙江省宁波市慈溪市周巷镇周西公路 1188 号 (315324)

Add: No.1188 Zhoushi Road, Zhouxiang Town, Cixi City, Ningbo, Zhejiang

电话 /Tel: 0574-58969272

传真 /Fax: 0574-58969289

网址 /Web: http://www.mubenlife.com

宁波木本生活电器有限公司为宁波兰花电器制造有限公司的全资子公司,公司成立于 2004 年,位于中国三大家电生产基地之一的宁波慈溪市。公司专注于厨房电器和清洁类电器,是集设计、研发、生产、销售于一体的实体企业,主要产品有三明治机、华夫饼机、牛排机、无线吸尘器 and 除螨仪,公司

严格按照 ISO9001-2015 标准生产销售,所有产品均通过 CCC/GS/CE-LVD/CE-EMC/ROHS/ETL/CETL 认证。

Ningbo Muben Life electric Appliances Co.,LTD. Is a wholly-owned subsidiary of Ningbo Orchid Electric Appliances Manufacturing Co.,LTD., founded in 2004, located in Cixi City, Ningbo, one of the three major home appliance production bases in China. Focusing on kitchen appliances and cleaning appliances, the company is a solid enterprise integrating design, research and development, production and sales. Its main products include sandwich machine, waffle machine, steak machine, wireless vacuum cleaner and mite eliminator. The company produces and sells products in strict accordance with ISO9001-2015 standard, and all products have passed CCC/GS/CE-LVD/CE-EMC/ROHS/ETL/CETL certification.

#### 主要展品 /Products

三明治机、华夫饼机、牛排机、无线吸尘器和除螨仪

sandwich machine, waffle machine, steak machine, wireless vacuum cleaner and mite eliminator

 宁波铝业  
NINGBO NINGZHENG ALUMINUM

### 宁波宁蒸铝业有限公司

#### NINGBO NINGZHENG ALUMINUM INDUSTRY CO., LTD

**W1-1B50**

地址: 浙江省慈溪市新浦镇新新路 388 号

电话 /Tel: 15258159000

宁波宁蒸铝业有限公司座落于杭州湾大桥南岸,世界闻名的小家电之乡—浙江省慈溪市。是一家拥有 20 余年行业经验的现代化企业,总占地 15000 m<sup>2</sup>,专业开发、生产、销售、服务冰箱、酒柜、陈列柜、饮水机蒸发器和太阳能集热板,其结构型式为板式(吹胀式)蒸发器,板式蒸发器型式有:单面吹胀、双面吹胀、部分单双面吹胀。

我司拥有自主进出口权、一般纳税人资质。

#### 主要展品 /Products

冰箱、酒柜、陈列柜、饮水机蒸发器和太阳能集热板,其结构型式为板式(吹胀式)蒸发器,板式蒸发器型式有:单面吹胀、双面吹胀、部分单双面吹胀。



### 宁波欧声电器有限公司

#### NINGBO ALLSING ELECTRICAL APPLIANCE CO., LTD

**E2-2A14**

地址: 浙江省宁波慈溪市新浦镇东工业区戚家路 183 号 (315300)

Add: No.183, Qijia Road, East Industrial Zone, Xinp, Cixi, Ningbo, China

电话 /Tel: 18312988528

网址 /Web: www.allsing.net

宁波欧声电器有限公司成立于 2018 年,我公司是一家专业从事滚筒式干衣机的研究、开发和生产的工厂,公司通过 ISO 9001 质量体系认证,目前公司员工 150 名,年生产销售 10 万台干衣机。所有产品均通过 CB, CE, GCC, FCC 认证,深受世界各地客户好评。

作为一家电器公司,我们对我们的行业充满热情。我们总是优先考虑顾客。为了塑造更好的生活

方式, 我们不断创造关爱, 让亿万人的生活更轻松、更舒适。

Ningbo Allsing Electrical Appliance Co., Ltd is located in Cixi, Zhejiang Province, on the South Bank of Hangzhou Bay, close to national highway 329, enjoying superior geographical environment and convenient transportation. Our company is close to Ningbo Beilun port and airports of Ningbo and Hangzhou, which is the heart of Shanghai.

Hangzhou and Ningbo Golden Triangle. Ningbo Allsing Electric Appliance Co., Ltd was founded in 2018. We specialized in the research, development and production of tumble dryer. All of our products meet international quality standards and are highly praised by different markets around the world. As an electrical company, we are passionate about our line of work and always put our customers in the first place. In order to create a better way of life, Allsing constantly creates care, taste and happiness experience, making the life of hundreds of millions of people more relaxed and comfortable.

#### 主要展品 /Products

滚筒式干衣机, 直排式烘干机, 烘干机, 壁挂迷你烘干机

Tumble dryer, clothes dryer, mini dryer, electric clothes dryer, clothes dryer machine, laundry dryer, portabl clothes dryer, compact clothes dryers, portable dryer, cloth dryer machine, cloth dryer, electric dryer, laundry dryer machine, dryer clothes, machine clothes dryer, electr clothes dryer machin, dryer machine for laundry.



#### 宁波欧胜电器有限公司 NINGBO OUSHENG ELECTRIC CO.,LTD.

W5-5B42

地址: 浙江省宁波市余姚市泗门镇泗北村科技路8号

Add: No.8 Keji Road, Sibeil Village, Simen, Yuyao, Ningbo, Zhejiang

电话 /Tel: 13456108218

宁波欧胜电器有限公司是专业生产世界各国插头电源线的制造工厂, 产品有 PVC 电源线、橡胶电源线、编织电源线三大系列, 主要为家用电器、厨房电器、电动工具、灯具等各个行业需要取电的电器产品配套合作, 公司占地面积 1 万平方米, 建筑面积 18000 平方米。

公司产品先后 16 个国家和地区的安规认证, 所用材料符合欧盟环保 ROHS 指令和 REACH 法规及 PAHS 与 DEHP 瑞取要求。

Ningbo Ousheng Electric Appliance Co., Ltd. is a manufacturer specializing in producing plug power cords from all over the world. Its products include PVC power cords, rubber power cords, and braided power cords. It mainly cooperates with household appliances, kitchen appliances, electric tools, lamps, and other industries that need power. The company covers an area of 10000 square meters and a building area of 18000 square meters.

The company's products have been certified by the safety regulations of 16 countries and regions, and the materials used comply with the European Union's environmental protection ROHS directive, REACH regulations and PAHS and DEHP Swiss requirements.

#### 主要展品 /Products

电源线, 延长线

POWER CORD, EXTENSION CORD



#### 宁波普尔机电制造有限公司 Ningbo Puer Mechanical Electrical Manufacturing Co., Ltd.

W3-3A01

地址: 浙江省余姚市陆埠镇五马工业区创利西路2号 (315420)

Add: No. 2 Chuangli West Road, Wuma Industrial Zone, Lubu Town, Yuyao City, Zhejiang, China

电话 /Tel: 86-0574-62320006

传真 /Fax: 86-0574-62380123

网址 /Web: www.nbpuer.net

宁波普尔公司是一家专业生产全自动台式变频小洗衣机、变频洗衣机用无刷直流电机、DD直驱、BLDC无刷直流电机、减速离合器、风机、变频动力组件及自动投液泵组件等产品的国家高新技术企业。配有先进的产品装配线以及全套测试设备, 具备年产 200 万套洗衣机用减速离合器、250 万套无刷直流电机及变频动力组件的生产能力。

公司是美的小天鹅、伊莱克斯(巴西)、南京创维等生产高档变频洗衣机企业的配套供应商。

Ningbo Puer is a national high-tech enterprise specializing in the production of Full-automatic frequency conversion small washing machine, and Brushless DC motor, DD motor, BLDC brushless motor, decelerated clutch, fans, variable frequency power components, and automatic detergent feeding pump components for frequency conversion washing machines. Equipped with advanced product assembly lines and a complete set of testing equipment, it has an annual production capacity of 2 million sets of clutches for washing machines, 2.5 million sets of brushless DC motor and variable frequency power components.

Puer is the supplier of famous washing machine manufacturers, such as Midea (Little Swan), Electrolux, Skyworth etc.

#### 主要展品 /Products

- ①台式变频小洗衣机
- ②滚筒洗衣机用直驱无刷直流电机
- ③滚筒洗衣机用无刷直流电机
- ④全自动洗衣机用无刷直流减速离合器组件
- ⑤减速离合器
- ⑥洗衣机用各类风机
- ⑦无刷直流电机驱动器
- ⑧自动投液泵组件

- ① Table type frequency conversion small washing machine
- ② DD brushless DC motor for front loading washing machine
- ③ Brushless DC motor for front loading washing machine
- ④ Brushless DC reducer components for full-automatic washing machine
- ⑤ Decelerated clutch
- ⑥ various fans for washing machine
- ⑦ Brushless DC motor driver
- ⑧ Automatic detergent feeding pump component



**SÖIKOI**

司 崎 库

**宁波千帆智能科技有限公司**

**E2-2A36 2A37**

地址: 浙江省宁波市鄞州区湖下路 217 号 1 幢 14F

电话 /Tel: 13777255517

电器品牌公司

**主要展品 /Products**

厨房电器、生活电器、个护电器、水杯、厨房用品

**Quan Ria**

**宁波泉立佳电器有限公司**

**E2-2D66**

**Ningbo QuanRia Electrical Appliance Co., Ltd.**

地址: 浙江省慈溪市周巷镇云城村团圈路 95 号 (315324)

Add: No. 95 Tuanquan Road, Yuncheng Village, Zhouxiang Town, Cixi City, Zhejiang Province.

电话 /Tel: 0574-63083888

传真 /Fax: 0574-63328738

网址 /Web: www.nbquanli.com

宁波泉立佳电器有限公司坐落在世界上最长的杭州湾跨海大桥南岸, 东南紧靠宁波, 西南与余姚接壤, 北与上海隔海相望, 地处沪、杭、甬经济金三角的中心地带。地理环境优美, 交通便捷, 宁波北仑国际集装箱码头 60 公里。

公司成立于 2001 年, 专业生产美发产品。公司集设计、开发、生产、销售于一体, 现有员工 350 名, 技术人员 22 名, 其中高级工程师 5 名。公司年产电吹风、电夹板能力达到 300 万台。

NINGBO QUANRIA ELECTRICAL APPLIANCE CO., LTD. is located on the southern banks of Hangzhou Bay Cross-Sea Bridge, the longest cross-sea bridge in the world. It is close to Ningbo in the southeast. It is adjacent to Yuyao in the southwest. It is separated by sea from Shanghai in the north. It is situated in the Central Belt of Shanghai, Hangzhou and Ningbo Economic Golden Triangle. It has the advantageous geographical environments and transport facilities. It is 60KM from Ningbo Beilun International Container Wharf.

Our company was established in 2001, and our advanced equipment is all kinds of Hair Care Products. QuanRia is a company with a whole line of designing, developing, producing and selling. Now there are 350 employees, 22 engineers and technicians in the company. And our company annual output capacity of hair dryer and hair straightener is 3.0 million units one year.

**主要展品 /Products**

电吹风, 直发器, 卷发棒, 热风梳, 美发套装

Hair Dryer, Hair Straightener, Hair Curler, Hot Air Brush, Hair Care Set

Rewell 日威

**宁波日威电器有限公司**

**E3-3A22**

地址: 浙江省宁波市慈溪市周巷镇开发东路 1000 号

电话 /Tel: 0574-63326588

创建于 1993, 30 年国货品牌匠心制造, 国内理发器行业盖得排名第一, 孙红雷代言, 产品远销德国 Lidl 大型连锁超市, 法国欧尚 Auchan 超市, 与美国个人护理类高端品牌 “Beard Club” 达成年采购量 30 万台战略合作伙伴关系。

产品畅销全球 6 大洲 155 个国家和地区, 合作华为 Hiiink 品牌剃须刀, 是国内知名品牌 babycare, 海尔, 创维等国内贴牌代工厂。

**主要展品 /Products**

毛球修剪器, 丰盈梳, 电动修足器, 剃须刀等个护类产品。

GREENHOME  
TECH

**宁波日盛科技有限公司**

**E1-1B23 1B24**

**NINGBO RIYI TECBHNOLGY CO., LTD**

地址: 浙江省慈溪市高新产业园区新兴二路 218 号 (315301)

电话 /Tel: 86-0574-58995788

传真 /Fax: 86-0574-58995682

<https://shop1481872017284.1688.com/?spm=a2615.7691481.0.0.71354630uxg2jp>

宁波日盛科技有限公司地理位置优越, 交通便利, 是一家以自主研发、开模、生产、销售及一体的专家家电制造企业。公司严格按照国家质量体系认证标准执行。在产品建设方面, 公司不断提升产品质量, 将国内外先进的技术和精湛的生产工艺融入到公司的产品制造中。我们始终坚持以市场为导向, 走科技兴厂的道路, 不断为消费者推出先进的家电产品和技术。

**主要展品 /Products**

吸尘器

**SHARNDY®**

**宁波瑞狄安采暖科技有限公司**

**W1-1B55**

**Ningbo Edeans Heating SYSTEMS Manufacturing Co., Ltd.**

地址: 浙江省宁波市鄞州区瞻岐镇鄞州经济开发区启航南路 818 号 (315145)

电话 /Tel: 0574-27866696

网址 /Web: www.edeans.com

宁波瑞狄安采暖科技有限公司成立于 2009 年, 为 “SHARNDY 想的” 品牌旗下企业。“SHARNDY 想的” 品牌创建于 2003 年, 为中国高端电热毛巾架领导品牌。成立至今, 公司一直专注于电热毛巾架、电热晾衣架、电热干鞋架等智能烘干祛潮产品的研发制造, 是国内较早从事新型智能电热毛巾架产品出口的企业; 目前, 产品 80% 出口到全球 50 余个国家和地区。

Ningbo Haishu SHARNDY Bathroom Fittings Company is a professional manufacturer focus on household electrical appliance. SHARNDY was founded in 2003. We enjoy a good reputation



worldwide with its supreme quality, competitive price and excellent service. SHARNDY products include electric clothes dryer, electric towel warmer, electric shoe dryer, floor heating system, etc. We have a first-class designer, engineer team to ensure we are a key player on the heating & electrical appliance business.

We have 17 years of factory experience, accepting OEM and ODM services. The factory is located in Ningbo, Zhejiang Province, China, covering an area of 11000 square meters. It has more than 160 employees, 6 production lines and a monthly production capacity of more than 60000 pieces. The products are sold to the European Union, Australia, the United States, Russia, with business in more than 50 countries around the world. More than 80 certifications, including: CUL, GS, S-Mark, SAA, CE, ROHS, etc.

#### 主要展品 / Products

想的主要生产电热毛巾架, 电热晾衣架, 电热干鞋架产品, 产品 80% 出口, 国内主要以高端酒店及楼盘为主。致力于改善用户生活品质。

SHARNDY is specialized in producing and selling Heated Towel Warmer、Electric Clothes Dryer、Electric Shoes Dryer. 80% of our products are exported to overseas market, mainly doing high-end hotels and Superb Mansion in the domestic market. We are committed to improving the quality of life of our users.



#### 宁波赛特斯电器有限公司

#### NINGBO CETUS ELECTRIC APPLIANCE CO.,LTD

地址: 浙江省宁波市慈溪市附海镇工业区 (315300)

Add: Industry Development Zone, Fuhai, Cixi, Ningbo, Zhejiang

电话 /Tel: 0574-58581660

传真 /Fax: 0574-63682883

网址 /Web: www.cn-cetus.com

E1-1E71

宁波赛特斯电器有限公司成立于 2003 年 1 月, 主要经营取暖器, 电风扇, 除湿机等生活小家电。公司拥有自有厂房 56000 平方米, 员工 500 人, 研发团队 50 余人, 15 条流水线, 100 余台注塑和冲压设备, 每年生产 350 万台 -400 万台小家电。

Founded in 2003, Ningbo Cetus Electric Appliance Co., Ltd is professional manufacturer with research, development, production and marketing which devotes to the development of healthy, safe, innovative and eco-friendly small home electronic appliances. The main products are including water dispenser, heater, electrical fan, dehumidifier and so on. Our factory building area over 56000 square meter, with some laboratory room and testing room.

#### 主要展品 / Products

取暖器, 饮水机, 除湿机, 风扇

heater, water dispenser, dehumidifier, electric fan



杉君

#### 宁波杉君电器有限公司

地址: 浙江省宁波杭州湾新区庵东镇工业园区沿江路 128 号

电话 /Tel: 0574-63075511

W5-5A22

宁波杉君电器成立于 2020 年 10 月 12 日, 是一家集家用电器研发、制造、销售于一体的新型科技公司。

#### 主要展品 / Products

手持式吸尘器, 除螨仪



#### 宁波神剑电器制造有限公司

#### NingBo Shenjian Electrical Appliance Manufacture CO.LTD

地址: 浙江省宁波市奉化区溪口镇葛丰路 1 号 (315502)

Add: Xi Kou, Economic Development Zone, FengHua, Ningbo, China

电话 /Tel: 15058408880

传真 /Fax: 0574-88882003

网址 /Web: Http://shenjian.en.alibaba.com

E3-3B36 3B37

宁波神剑电器制造有限公司成立于 1994 年, 公司专注于智慧个人护理产品的研发、生产、销售, 包括理发器、剃须刀、电吹风, 电动牙刷、美容仪器等系列产品。

2020 年公司实现产值 2.1 亿元, 预计 2021 年产值将超 3 亿元。神剑电器将继续秉承“全神铸剑”精神, 恪守“创新·分享”的价值观, 营建神剑电器自有“神剑 GTS”、“HORD”品牌, 努力把公司打造成为智慧个护电器领域标杆企业。

Ningbo Shenjian Electrical Appliance Manufacture Co.Ltd

Ningbo Shenjian Electrical Appliance Manufacture Co., Ltd is a professional manufacturer and exporter of electrical hair clipper, animal clipper, hair dryer and other hair care products. It is located in Xikou Economic development zone, Fenghuacity. 60km away from Ningbo port and 25km away from Ningbo international Airport.

Our company abides by the mode of modern management and strictly runs with the standards of ISO9001:2000 to produce high quality products. Most of our products are qualified with GS/CE/TUV/ROHS safety approvals and built up good reputation from inland and overseas market. They have been marketed into Europe, Middle East, North America and other areas.

Target: We possess abundant technology force, advanced technological equipment and all necessary fitting and test means. Concentrate on high grade and innovative hairdressing series, good services, prompt delivery and insist on the principle of credibility and win to win,

#### 主要展品 / Products

理发器, 吹风机, 剃须刀, 毛球器, 脱毛仪

Barber, Hairdrier, razor, hair ball apparatus, depilator

**宁波升谱光电股份有限公司**  
**NINGBO SUNPU LED CO.,LTD.****E2-2H86**

地址: 浙江省宁波市国家高新区新晖路 150 号

Add: No. 150, Xinhui Road, national high&amp;tech Zone, Ningbo, Zhejiang

电话 /Tel: 0574-87901628

传真 /Fax: 0574-87902332

网址 /Web: <http://www.sunpu-opto.com>

升谱光电专注于 LED 光电半导体的封装和创新, 拥有中国 CNAS、德国 TUV 莱茵、TUV 南德、Intertek 及 SGS 认可实验室。核心产品有车规级共晶 LED、车规级 TOP LED、UV LED、COB、LAMP LED、IR LED、CHIP LED、DISPLAY、VCSEL、UVC 杀菌模组、LED 模组等。产品应用于汽车、家电、照明、交通显示、烟感、杀菌医疗类大健康、智能穿戴等领域。

SUNPU LED focuses on LED semiconductor packaging and innovative applications. We have CANS, TUV Rhein, TUV Sud, Intertek and SGS laboratories. The core products include vehicle grade eucrytal LED, vehicle grade TOP LED, UV LED, COB, LAMP LED, IR LED, CHIP LED, DISPLAY, VCSEL, UVC sterilization module, LED module, etc. The products are used in automobile, home appliances, lighting, traffic display, smoke sense, sterilization, medical big health, smart wear and other fields.

**主要展品 /Products**

空净杀菌模组

表面杀菌模组

静态水杀菌模组

过流式动态水杀菌模组

Air sterilization module

Surface sterilization module

Static water sterilization module

Overflow dynamic water sterilization module



SHENG HANG

**宁波胜航电器有限公司**  
**Ningbo Shenghang Electric Appliance Co., Ltd.****W3-3H93**

地址: 浙江省余姚市泗门镇镇西北路 58 号 (315470)

Add: No. 58 Northwest Road, Lianshuxia Town, Simen Town, Yuyao City, Ningbo City,

Zhejiang Province, China

电话 /Tel: 0574-62103988

传真 /Fax: 0574-62103988

网址 /Web: [www.china-shenghang.com](http://www.china-shenghang.com)

宁波胜航电器有限公司主要生产和销售各国认证电源线、橡胶线、电器配件、插头、灯串线; 目前

拥有 PVC 粒子、电线押出、插头成型等生产设备 30 多台; 拥有电气、物理特性测试及量仪等检测设备 10 余台及机电维修设备 5 台。公司创建于 2013, 占地面积 8000 平, 员工 100 余人, 电线年产量可达 2000 万米, 年产值超过 8000 万人民币。企业理念: 讲究时效、完善管理、提升品质、增创效益。热烈欢迎客户前来我司检查参观。

Ningbo Shenghang Electric Co., Ltd. is a power cord of various countries, extension cord plug, socket, power strip, plastic accessories, waterproof plug, AC power cord, computer power cord, connector accessories, string lights, rubber power cord and other products professional production and processing manufacturer, we have a complete and scientific quality management system. Ningbo Shenghang Electric Co., Ltd, strength and product quality have been recognized by the industry. Pre-sale service, 1. Provide technical consultation: We will provide you with any professional technical and price consultation according to your needs within 10 hours, and mail relevant samples and product information, or promptly respond to any questions you are concerned about Give a quick response. 2. Provide inspection reception: We welcome you to visit the manufacturer for on-site inspection anytime and anywhere, and provide you with any convenient conditions

**主要展品 /Products**

各国认证电源线、插头线、橡胶线、电线、电缆、电器配件、插头、灯串线

Certified power cords, plug, rubber cords, wires, cables, electrical accessories, light string cords from various countries



SungRoy 時榮

**宁波时荣电器科技有限公司**  
**NINGBO SUNGROY ELECTRIC APPLIANCES TECH.CO., LTD****N3-3A38**

地址: 浙江省慈溪市逍林镇逍林大道 1658 号 (315321)

Add: No. 1658, Xiaolin Street, Xiaolin Town, Cixi City, Zhejiang Province, China

电话 /Tel: 0574-63511563

传真 /Fax: 0574-63507818

网址 /Web: [www.sungroy.com](http://www.sungroy.com)

我们公司是一家工贸一体的工厂, 主要生产家用电器, 坐落于浙江省慈溪市逍林镇。由 2005 年成立, 公司面积 25000 平方米。有先进的注塑设备、测试设备, 有经验丰富的团队, 严把质量, 诚信天下。

Our factory is a professional manufacturer for small household appliances, integrating product development, tooling fabricating, mass production and assembling. We are located in Ningbo with convenient transportation access. Established in 2005, in a modernized industrial zone covering 25000 square meter. With Advanced injection machines, processing machine, experienced staff and a strong technical force give us a good foundation for larger-scale production, also established a comprehensive quality control system according to ISO9001 standards.

**主要展品 /Products**

我们公司主要生产蒸汽清洗机、取暖器、灭蚊器等, 产品有 CE, GS, ROHS, ETL 等认证, 可以 OEM, ODM。

Our factory mainly covers three categories of products: Steam Cleaner & Photo-catalyst Mosquito Trap & Electric Heater. As an experienced factory in this field, we have built long term relationship with worldwide companies, and win a good reputation all over the world. In addition, with CE, GS, RoHS, ETL and SAA certificates.



## 宁波市金狼电器有限公司

E2-2G81

## Ningbo Kinglong Electric Appliance Co., LTD

地址: 余姚市梨洲街道新墅村叶岙路东 111 (311202)

Add: No.111th Yeao road, Xinshu Village, Lizhou street, Yuyao City, Zhejiang Province

电话 /Tel: 15067192576

网址 /Web: www.klelc.com

宁波金狼电器有限公司座落于长江三角洲经济中心 -- 宁波, 是一家拥有自主工程测试中心和新产品研发中心, 具有强大技术开发能力的企业。公司采用国内外先进生产设备, 拥有机械化、自动化流水线。

我们建立了完善的质量管理体系 ISO9001:2015、职业管理体系 ISO14001:2015, 所有产品均已通过 CE、ETL、SAA、FCC 等安全标准, 所有产品均经国家质量监督检验中心认证。

Ningbo Kinglong Electric Appliance Co., LTD is located in Yuyao Ningbo, The famous home electric appliance town. It covers an area of 30000 square meters, with more than 200 skilled workers and technicians. Also we have passed ISO9000, ISO4000 and BSCI. All of our products are with high quality and can meet different quality standard for different markets.

We mainly produce air purifier, coffee maker, tower fans, coolers and heaters, with OEM&ODM service, which are sold to Europe, North America, Asia and China's domestic.

We have our own R&D team and sales team, Strong Development ability and flexible process help us to develop about 10 new designs every year. Our customers are including supermarkets, distributors, online stores, brand owners and designers.

## 主要展品 /Products

空气净化器, 暖风机, 冷风机, 塔扇, 咖啡机等

Air purifier, Cooler and heaters, Towel fan, Coffee maker



## 宁波市清朗电器有限公司

E2-2B13

## Ningbo Qinglang Electric Appliance Co., LTD

地址: 慈溪市观海卫镇工业东区桃园东路 85 号

电话 /Tel: 15888086702

网址 /Web: www.kyfengroup.com

宁波市清朗电器有限公司是一家集科研、设计、生产和销售为一体, 自主创新的技术型企业, 拥有大批高级工程师和专业管理人才, 是目前国内较大的空气净化器专业制造商之一。公司通过 ISO9001 国际质量体系认证, BSCI 社会责任审核, 产品通过 ETL、GS、CE、CCC 等认证。公司产品凭借专业的水平和成熟的技术, 获多项专利。清朗竭诚为您提供高性价比的专业产品、高质量的设计制造技术及无微不至的售后服务。

## 主要展品 /Products

空气净化器



## 宁波市塞纳电热器有限公司

N2-2B47

## Ningbo Sunny Electrical Heating Appliances Co., Ltd.

地址: 浙江省宁波市慈溪市杭州湾新区滨海四路 177 号 (315336)

Add: No.177, BinhaiSi Road, Hangzhou bay New Zone, Ningbo, Zhejiang, China 315336

电话 /Tel: 0574-23678120

传真 /Fax: 0574-23678113

网址 /Web: www.sunnyheater.com

宁波市塞纳电热器有限公司成立于 1998 年 2 月, 为国家级高新技术企业, 现有员工六百余人, 占地 10 万平方米。现有 50 多名专业技术人员, 产品线涵盖管状发热元件、复合发热元件、医疗加热器、五金冲压拉伸件和稀土厚膜加热器。

公司与 SEB、西门子、Philips、飞利浦伟康、美的、苏泊尔、方太、科沃斯等世界 500 强及国内知名企业建立了长期良好的合作关系, 目前每年提供超 3000 万只各类加热器给客户。

Ningbo SANA Electric Heating Appliance Co., Ltd. was founded in February 1998, as a national high-tech enterprise, the existing employees of more than 600 people, covering an area of 100,000 square meters. Currently, the company has more than 50 professional and technical personnel, and its product line covers tubular heating components, composite heating components, medical heaters, metal stamping and stretching parts and thick film heaters. The company has established long-term good cooperative relations with the world's top 500 and domestic well-known enterprises such as SEB, Siemens, Philips, Philips Vikon, Midea, Supor, Fotile, Ecovacs, etc. At present, more than 30 million heaters of various types are provided to customers every year.

## 主要展品 /Products

电加热盘, 电加热管, 蒸汽发生器, 蒸汽锅炉, 铝压铸, 稀土厚膜加热器, 医疗加热器, 单头加热管, 不锈钢冲压拉伸件

Electrical heating plate, Electrical tubular heater, Steam boiler, Aluminum diecasting, Thick film heater, Medical heater, Cartridge heater, S/S deep drawing parts



## 宁波市善纶电器有限公司

W4-4A51

## Ningbo Shanlun Electric Appliance Co., Ltd

地址: 慈溪市周巷镇 芦庵路 88 号

电话 /Tel: 0574-63771195

宁波市善纶电器有限公司成立于 2019 年, 主要生产小家电产品。公司座落于浙江宁波慈溪周巷。占地面积 20000 平方米。员工人数 120 多人。

我司配有先进生产设备, 精密测试仪器, 可靠的实验设施, 先进装配流水线。主要产品包括三明治机, 煎烤器等。所有产品已通过 GS/CE 认证。产品远销欧盟, 美国, 中东, 东南亚地区。

欢迎参观莅临指导我司, 期待与您建立业务关系!

Ningbo shanlun electric appliance co., LTD established in 2015, is one of leading manufacturers specialized in small electric appliances. It is situated at Zhouxian town, Cixi city, Ningbo, Zhejiang province P.R. China.

We are nearby Ningbo, Hangzhou and Shanghai express way, 80KMS west to the eastern big

seaport Ningbo port. We covers and area of over 20,000 square meters. The total staff are more than 120.

We owns advanced manufacturing equipment, precision test devices, reliable experimental facilities, advanced production assembly lines and product design development center. Main products included sandwich maker, contact grill, etc... The quality with GS/CE approvals. And which has already sold to European Union, USA, Middle East, South Asia Etc.

Warmly welcome the friends and clients all over the world come to visit us, and anticipate to establish the business relationship with you soon!

#### 主要展品 /Products

三明治机、烤肉机、牛排机 .



#### 宁波市顺泰电器有限公司

#### NINGBO SUNTA ELECTRICAL APPLIANCE CO., LTD

地址: 浙江省慈溪市掌起镇叶东公路 1 号 (315313)

电话 /Tel: 0574-63753806

传真 /Fax: 0574-63742303

网址 /Web: <http://www.cnsuntai.com/cn/>

公司 2000 年获得 ISO9001 国际质量管理体系认证, 体系过程控制正逐步执行 QS9000 管理标准, 公司现有员工 320 多人, 高级工程师 2 人, 中级工程技术人员 8 人, 具备较强的产品研发能力。并能根据市场需求变化, 快速应变, 适时调整市场战略, 开发出新产品。公司检测设备齐全, 检测手段先进, 具有生产发展的极大潜力。

#### 主要展品 /Products

牵引器、定时器、分流阀



#### 宁波市小蜂电器有限公司

#### Ningbo Bees Electric Appliance Co.,Ltd.

地址: 浙江省慈溪市长河镇五塘路 2 号 (315301)

电话 /Tel: 15990589016

传真 /Fax: 0086-574-63315386

网址 /Web: [www.nbjufa.com](http://www.nbjufa.com)

宁波市小蜂电器有限公司是一家集研发、生产、销售厨房类电器的领军企业, 目前主要生产空气炸锅, 空气烤箱, 等产品。公司坐落于中国电器之都慈溪, 自有在建厂房 11 万平方米。

小蜂拥有自有模具车间, 集模具设计, 制造, 产品的加工, 装配于一体。

公司具有完善的质量控制体系, 所有的产品均申请专利并达到国际认证标准。目前拥有 40 多名质量控制团队

NINGBO Bees ELECTRIC APPLIANCE CO.,LTD since start in 2008, and it is a leading manufacturer of Personal care industry, NINGBO Bees is specialized in Hair Dryer, Hair straightener, Hot Air Styler, Hair trimmer, Hair curling iron etc.

Currently the main market is in Europe and south America including Germany, Italy, UK, France,

W2-2A47

N3-3A12

Brazil, Russia U.S.A and many other countries.

Bees is certified with the international ISO9001:2000 quality assurance standard . All Bees products are factory-designed and patented, Moreover, has got GS/CE/EMC/ROHS/PAH/REACH approval of European Union as well as American UL, ETL certificate.

OEMS/ODMS is welcome to customers all over the world.

#### 主要展品 /Products

空气炸锅, 空气烤箱

Air Fryer

## OMUONE

### 欧慕尼

#### 宁波市新享科技有限公司

#### Ningbo Newxiang Technology Co., Ltd.

地址: 浙江省宁波慈溪市宗汉驿淘产业园

电话 /Tel: 0574-63210959

网址 /Web: [www.omuone.com](http://www.omuone.com)

近 15 年小家电设计、研发和销售经验, 2019 年转型研发高速吹风机、便携剃须刀等个人护理类产品。爆款高速吹风机累计销量突破 400000 台, 单款销售额超 1 亿元, 产品热销中日韩、澳洲和欧洲。

#### 主要展品 /Products

具有差异化的高速吹风机、便携剃须刀、多功能冲牙器等个人护理类小家电



#### 宁波市长利自动化电器有限公司

#### NINGBO CHANGLI AUTOMATIC APPLIANCE CO.,LTD.

地址: 宁波市余姚市低塘街道胜周路 188 号 (315400)

Add: NO.188 SHENGZHOU ROAD, TANGJIAZHA VILLAGE, DITANG STREET, YUYAO, ZHEJIANG

电话 /Tel: 0574-62228238

传真 /Fax: 0574-62228238

宁波市长利自动化电器有限公司, 一家集产品研发, 生产与销售于一体的企业, 持续在家用清洁电器行业深入钻研。自 2012 年建厂以来, 我们与许多国内的公司建立了长期合作的战略合作伙伴关系, 次年我们成立外贸部门, 自此开始积极开发国外市场。

Ningbo Changli Automatic Appliance Co.,Ltd., a private enterprise combines product R&D, production and sales, specializing in 1 category, household cleaning appliance. Since established in 2012, a large amount of domestic companies have good long-term business relationship with us. And in 2013, our foreign trade department had been established to explore foreign market.

Our factory is trying to use more automatic machine instead of human work, like mechanical arm and automatic screw machine, which leads to stable quality and efficient work. Within 9 years' production team, customers who are strict on details has been satisfied with their finished orders. And to keep competitive in this market, factory keep developing 1-2 new items every year and

E3-3F71

E2-2A32





tracing the user experience by selling in our own online store, collect user's feedback in 2-3 months.

#### 主要展品 /Products

电动扫地机, 电动拖把, 地板打蜡机, 电动清洁刷, 迷你吸尘器  
ELECTRIC SWEEPER, ELECTRIC MOP, FLOOR POLISHER, ELECTRIC CLEANING BRUSH, MINI VACUUM CLEANER



顺和电子科技

#### 宁波顺和电子科技有限公司

**Ningbo Shunhe Electronic Technology Co., LTD**

**W1-1B05**

地址: 浙江省慈溪市坎墩街道顺和路 177 号

电话 /Tel: 057423450589

传真 /Fax: 057423450589

网址 /Web: <http://www.nbshunhedz.com/m/index.asp>

宁波顺和电子科技有限公司位于浙江省宁波地区, 是集研发、制造及销售于一体的微电脑控制板 (PCBA) 生产厂家。产品包括大部份的生活家电控制板、厨房家电控制板以及部分工业用途产品与设备的控制板。

#### 主要展品 /Products

是集研发、制造及销售于一体的微电脑控制板 (PCBA) 生产厂家



#### 宁波舜韵电子有限公司

地址: 浙江省余姚市泗门镇四海大道 96 号

电话 /Tel: 18858225519

**N1-1A38**

宁波舜韵电子有限公司是一家以厨电智能控制系统为核心, 集设计、研发、生产、销售于一体的专业化公司。公司具有完备的技术和产品体系, 建有省级技术研发中心、省博士后工作站, 在触摸控制、传感控制、变频控制等领域拥有雄厚技术力量, 拥有百余项专利技术、软件著作权及科技成果, 居行业领先地位。公司研发生产的智能控制系统主要应用于油烟机、集成灶、洗碗机、燃气报警等产品, 是方太、火星入、亿田等国内知名品牌的战略供应商。

#### 主要展品 /Products

智能控制系统



#### 宁波泰威特电器有限公司

**Ningbo Taiweite Electric Appliance Co., Ltd**

**E1-1A46 1A47**

地址: 中国浙江省宁波余姚市泗门工业区固北路 29 号 (315470)

Add: 29th Gubei Road, Si Men Industrial Park, Yu Yao, Zhejiang, China 315470

电话 /Tel: 86-0574-62128001

传真 /Fax: 86-0574-62128008

网址 /Web: [www.tywit.com](http://www.tywit.com)

宁波泰威特电器有限公司

创建于 2003 年, 位于浙江宁波, 公司员工人数 350 人, 公司占地 5 万平方米, 2020 年营收 2 亿元, 集研发、生产、销售为一体的综合性制造企业。

Ningbo Taiweite Electric Co., Ltd. (TT Smart Technology Co., Ltd) was founded in 2003, is located in the economic center of the Yangtze River Delta - Ningbo, we are an independent engineering testing center and new product research and development center, with strong technology development ability of the enterprise. The company adopts domestic and foreign advanced production equipment with mechanization, automation streamline.

#### 主要展品 /Products

移动空调, 除湿机, 空气炸锅, 三明治  
portable air conditioner, dehumidifier, air fryer, sandwich maker



#### 宁波天祺科技有限公司

**Ning bo Tianqi Technology Co., Ltd**

**N1-1C86**

地址: 浙江省宁波市宁海县力洋镇金港路 21 号

电话 /Tel: 0574-82550773

网址 /Web: [www.tianqitechnology.com](http://www.tianqitechnology.com)

雾能是一个专注于空气净化领域, 为用户提供洁净的空气、解决服务商。

产品系列

包括空气净化器、银离子灭菌口罩、汽车空调滤芯、车载净化器、空气质量检测仪等。

品牌文化

雾能使命: 致力于为人类提供一个清新的空气环境。

雾能愿景: 做空气净化领域的领路人。

品牌理念: 长期把服务和产品技术创新放在首位, 用户至上, 将对工作的热情、对使命的虔诚和对美好生活的向往融入到产品之中。

#### 主要展品 /Products

雾能空气净化器采用银铜锌离子络合杀菌复合滤网, 是经王博士团队多年研发, 推出的全新一代除醛杀菌技术, 利用银铜锌离子络合杀菌滤网 + HEPA 滤网 + 柱状活性炭吸附层, 吸附分解甲醛成水和二氧化碳, 避免二次释放同时兼顾灭菌, 荣获国家发明专利。专利号 ZL20081011551



### 宁波天瑞智能科技有限公司

W2-2H51

地址: 浙江省余姚市泗门镇工业园区 (315470)

电话 /Tel: 0574-62132758

网址 /Web: www.cnifamily.com

宁波天瑞成立于 1995 年, 坐落于人杰地灵的阳明故里 -- 浙江余姚。工厂面积 10 万平方米, 员工 700 余人。致力于空气净化, 新风系统等绿色智能家电产品和户外智能应急产品的研发, 生产与销售。天瑞与多个世界 500 强企业战略合作, 产品远销全球百余国家和地区, 已成为空净和户外应急领域知名龙头企业。先后荣获“十三五”中国十大环境电器出口企业; 2021 年度“科技创新产品”南山奖; 2022 年度宁波市“专精特新”企业。

#### 主要展品 /Products

空气净化器, 空气消毒机, 新风机。



图兰多

### 宁波图兰多电器有限公司

E2-2A40 2A41

Ningbo Turando Electrical Appliances Co.,Ltd

地址: 浙江省宁波市慈溪杭州湾新区庵东镇双创产业园纬一路 999 号 (315327)

Add: Add.: 999 Weiyi Rd, Andong Town, Hangzhou Bay New Zone, Ningbo, Zhejiang

电话 /Tel: 18069035305

网址 /Web: http://turando.com

宁波图兰多电器有限公司是一家基于核心技术创新的小家电制造企业, 也是中国成立较早、发展较成熟的咖啡机工厂, 产品远销世界各地并广受好评。公司能够提供全系列胶囊热饮料系统解决方案的供应商, 自行设计和生产胶囊被踢, 自动灌装生产线及主营的冲泡机系列产品。咖啡机产品绝大部分核心部件可以自给自足且拥有自主知识产权, 因此拥有较强的竞争力, 包括家用、高端商用、小型商用, 办公室用, 商用, 自动售卖等全部应用场景。

Turando is a comprehensive company combined with original design, R&D, manufacture and sales. As one of the leading capsule coffee machine manufacturers in China, we are providing solutions of whole coffee filling and sealing, brewing and vending in one stop.

#### 主要展品 /Products

咖啡机、奶泡机、电热饭盒、即热式开水机、恒温碗 ...

coffee machine, milk frother, instant lunch box, instant water dispenser, smart baby feeding bowl ...



### 宁波万泓科技有限公司

E2-2B23

Ningbo Wanhong Technologies Co.,Ltd.

地址: 宁波市北仑区新碶街道明州西路 580 号 (315800)

Add: No 580 West Mingzhou Road, Xinqi Street, Beilun District, Ningbo 315800

电话 /Tel: 0574-86115507

传真 /Fax: 0574-86111688

网址 /Web: www.wahogroup.com

成立于 2009 年, 毗邻中国最大的深水港 - 北仑港, 距宁波栎社机场仅 25 公里, 交通十分便利。公司是一家专业从事即热式开水机和厚膜发热管的研发、生产与销售为一体的现代化高新技术企业。现拥有 15880 m<sup>2</sup> 厂房, 独立的实验室和厚膜研究院。坚持以产品安全为第一要素, 获得了 GS/CB//3C 等认证, 同时获取了 ISO9001:2015 和 BSCI。拥有数十名中高级研发和管理人才, 全套生产设备和检测仪器等制造设备。

Established in 2009, Wanhong is one of the important suppliers of the stainless steel think film heating system and instant boiler in China. We particularly focus on new technology innovation & design, R&D, manufacturing and sales. Our goal is to create the new life of health drinking water, lower carbon and saving energy.

Product range covers all kinds of instant boiler, 3rd generation stainless steel thick film heating system.

we have total 33,350 m<sup>2</sup> factory location, have own lab and R&D center which we cooperated with university professor, built in the university.

Our Vision is to be one of the best professional small kitchen appliances company in the world!

Our Mission is to get the people live on NutriLife.

#### 主要展品 /Products

热式开水机、即热式壁挂机、即热式袋装水专用机、4-11L 小桶装水专用机、压缩桶装水专用机、不锈钢膜发热体和不锈钢发热管

stainless steel think film heating system and instant boiler



### 宁波万事达综研电气有限公司

W3-3D115

NINGBO MASTER SOKEN ELECTRICAL CO.LTD.

地址: 浙江省宁波市溪口工业园区综研路 19 号 (315502)

Add: No.19 Zongyan Road, Xikou, Ningbo, China

电话 /Tel: 13585545336

传真 /Fax: 0574-88847368

网址 /Web: http://www.chinasoken.com

宁波万事达综研电气有限公司是中国电器工业协会电器附件及家用控制器分会理事单位, 位于长江三角洲南翼, 国家“AAAAA”级风景旅游区宁波溪口, 陆海空交通便捷, 人文环境得天独厚。公司厂区占地面积 16000 平方米。年产各类开关 15000 万只以上, 为国内同行之前列。公司 1999 年 7 月通过 ISO9001 质量管理体系认证, 产品通过多个国家和地区的安规认证, 符合 RoHS 指令检测项目之标准。

NINGBO MASTER SOKEN ELECTRICAL CO.LTD. established in 1996, is a director member of Electrical Accessories and Appliance Controllers Branch of CEEIA. We are located in Xikou, Ningbo with convenient transportation access. Our Factory covers gross construction area of 25,000 square meters with site district area for 16,000 square meters. Our company obtained ISO 9001 certification in July 1999 and ISO 14001 certification in October, 2004. Dedicated to strict quality control and thoughtful customer service and ensure full customer satisfaction. Our company also has the laboratory according to UL, TUV inspection standard. In addition, we have obtained UL, VDE, TUV, ENEC, KEMA, K, CQC, safety approvals and certificates and RoHS-compliant. Selling well in all cities and provinces around China, our products are also exported

to clients in such countries and regions as America, Europe, Asia, Middle. We also welcome OEM and ODM orders.

#### 主要展品 /Products

我们专业研发设计制造各种规格型号之跷板开关、旋转开关、按钮开关、琴键开关 以及指示灯。产品广泛运用于家用电器、工业设备、仪器仪表、通讯设备、健身美容器材等 各个方面。公司可代为开发设计制造有特别要求的开关产品。

We are professional manufacturer engaged in the research, development, production, sale and service of various switches, including Rocker switches, Rotary switches, Push-button switches, Key switches, Indicator lights which are widely used in different fields such as Home Appliances industrial Facilities, Instruments and Meters, Communication Equipments, Fitness and Beauty Apparatus and so on.



#### 宁波维盛电器有限公司

#### NINGBO VASION ELECTRIC APPLIANCE CO.,LTD.

N3-3B01

地址: 浙江省慈溪市新浦镇高桥村四塘江路3号 (315300)

Add: No.3 Sitangjiang Road,Gaoqiao Village,Xinpu Town Cixi City,Zhejiang Province.

电话 /Tel: 13245615555

传真 /Fax: 0574-63028057

网址 /Web: http://www.vasion.com.cn

宁波维盛电器有限公司成立于2010年,经过不断努力和发 展,现已成为一家拥有多种厨房产品的专业工厂,主要产品有:空气炸锅等厨房家电产品。公司建立形成了科学化的管理体系,从产品设计研发,管理到模具制造、注塑、冲压生产、装配、测试到专业销售团队、营销团队、售后团队,体系化的配套流程和 专业人员使公司成为了行业的标杆企业。以满足广大国内外客户和 市场的需求并 已承接多种产品的 OEM、ODM 项目。

was founded in 2010, who is a professional manufacturer in kitchen appliances. Our major products are Air fryer,Kettle,Toaster,Egg boiler,Food dehydrator,BBQ etc. There are three production lines and we are steady continuous growing. With the development of the living standard, more and more people want to create a great life. We had established a perfect working-flow instruction and formed scientific documentary management system with modern characteristics.Our products are high international standard, strong design capability; we have domestic and overseas clients, fluent English communication skill workers, punctual lead time and competitive pricing.

We will continue to develop towards high technology and targets to be market leader based on advanced technology, teamwork and professionalism. We look forward to participating in the success with customers from all over the world.

We have BSCI, ISO9001, CE/EMC/IEC/ETL/CB/UL/ERP/ROHS.

#### 主要展品 /Products

空气炸锅 / 烤箱 / 面包机 / 煮蛋器 / 酸奶机 / 薄饼机

Air frying pan/coal-scuttle/Bread machine/Egg Cooker/Yogurt machine/Pancake machine

## HWIYS

### 宁波未十电器科技有限公司

E1-1F86

地址: 浙江省慈溪市北三环东路 1988 号恒元广场 A 座 2001 (315300)

电话 /Tel: 18058565566

传真 /Fax: 18058565566

网址 /Web: www.hwiy.com

宁波未十电器科技有限公司有限公司成立于 2015 年,是一家产品创新与制造公司。到目前为止,我们已经建立了自己的产品设计和自主创新新家电工厂。通过符合 IOS9001:2000 标准的全面质量控制体系,保证我们的产品创新力和竞争力。

Ningbo Hwiys Commerce Co., Ltd. is a product innovation & manufacturing company which is established in 2015. Till now we have found our own product design centre and factory for self-innovation home appliances. With comprehensive quality control system according to IOS9001:2000 standards, we can guarantee our clients the stable quality and efficient ODM project performance.

#### 主要展品 /Products

电热毛巾架 / 取暖器 / 油汀 / 风扇

Tower Warmer/Heater/Oil Heater/Fan



### 宁波沃丰厨卫科技有限公司

#### Ningbo Woofun Kitchen And Bath Technology Co., Ltd.

N1-1A26

地址: 浙江省宁波市慈溪坎墩工业区政通路 369 号 (315303)

Add: #369 Zhengtong Road, Kandun Town, Cixi, Zhejiang, China

电话 /Tel: 18058595175

网址 /Web: cnwoofun.com

宁波沃丰厨卫科技有限公司是专业生产厨卫通风节能环保产品的高新技术企业,公司通过 ISO9001 质量体系认证,并成为专精特新小巨人企业。公司生产面积约 28000 m<sup>2</sup>,主要产品有风管系列、新材料系列、通风配件系列、活性炭空气过滤器系列等。沃丰集研究、生产、销售、服务于一体,坚持高品质和周到服务,秉承“诚信为本、客户至上、精进卓越、共创共赢”的经营理念,努力提升人们的生活品质,让环境更舒适,让生活更美好。

Ningbo Woofun Kitchen And Bath Technology Co., Ltd. is a high-tech enterprise specializing in the manufacture of ventilation energy-saving and environmental protection products. Our main products are aluminum foil duct, aluminum foil, stainless steel pipe, PVC and aluminum combine duct, Semi-rigid aluminum duct, and activated carbon air filters, ventilation systems equipment and other accessories.

“Strive to improve people's quality of life through superior products. Better environment, better life” is our unchanged corporate Mission. The company covers an area of 28,000 square meters and has passed the ISO 9001 quality system certification in 2019 and approved by the National related department.

Ningbo Woofun is a professional enterprise in research, production, vendition and service. The company has the skilled management, advanced production equipment, several production lines and quality production troop. Ningbo Woofun sincerely looks forward to working with you.

**主要展品 /Products**

铝箔烟管、不锈钢风管、防爆膜、铝箔防爆板、吸音棉、保温管、消音管、纯铝管、过滤器  
Aluminum foil duct, stainless steel air pipe, anti-exposure film, aluminum foil explosion-proof board, sound-absorbing cotton, insulated air duct, soundproof duct, Semi-rigid aluminum duct, activated carbon filter

**宁波夏康电器科技有限公司****W1-1B46****NINGBO XIAKANG ELECTRICAL TECHNOLOGY CO.,LTD**

地址: 浙江省慈溪市新浦镇纬三路 18 号 (315300)

电话 /Tel: 13454755385

传真 /Fax: 0574-63975955

我司创办于 2018 年, 专业生产家用移动空调、除湿机。工厂位于中国小家电中心 - 慈溪。产品远销欧美, 全线产品符合 CE ROHS 等欧盟相关认证。

Our factory is established at 2018, we are professional manufacturer of portable air conditioner, dehumidifier. The factory locates in Cixi which is the center of China home appliances.

**主要展品 /Products**

移动空调, 除湿机

Portable air conditioner, dehumidifier

**宁波翔荣精密模具有限公司****W1-1A10 1A11****Ningbo Xiangrong Precision Mold Co., Ltd**

地址: 浙江省宁波市慈溪市龙山镇湖滨北路 16 号 (315312)

Add: No. 16, Hubin North Road, Longshan Town, Cixi City, Ningbo City, Zhejiang Province

电话 /Tel: 15906547091

网址 /Web: www.xrmj.com

宁波翔荣精密模具有限公司, 是一家中日合资企业, 位于杭州湾跨海大桥南岸的宁波慈溪市科技园区, 地理环境优越, 交通这便捷, 离宁波机场 50 余公里, 距北仑港约 70 公里。公司经过多年的努力和发展, 现已经为宁波慈溪市模具骨干企业, 慈溪市模具行业协会副会长单位, 宁波市模具行业协会常务理事单位。2019 年评选入围中央电视台《匠心智造》栏目企业。目前主要客户有夏普、松下、海尔、惠而浦、三菱、美的、无锡小天鹅、TCL 等。

Ningbo Xiangrong Precision Mould Co., Ltd. is a Sino Japanese joint venture located in the Ningbo Cixi Fanshi Science and Technology Park on the south bank of the Hangzhou Bay Cross Sea Bridge. The geographical environment is superior and the transportation is convenient. It is more than 50 kilometers from Ningbo Airport and about 70 kilometers from Beilun Port. After years of efforts and development, the company has become a backbone mold enterprise in Cixi, Ningbo, a vice president unit of Cixi Mold Industry Association, and a standing director unit of Ningbo Mold Industry Association. In 2019, it was selected as a shortlisted enterprise in the CCTV "Craftsman's Mind Making" program. Currently, the main customers include Sharp, Panasonic, Haier, Whirlpool, Melling, Midea, Wuxi Little Swan, TCL, etc

**主要展品 /Products**

翔荣模具专业制造洗衣机、冰箱类家用电器注塑模具, 有着 20 多年的生产设计经验。给国内外知名家电品牌做模具配套。目前主要客户有夏普、松下、海尔、惠而浦、三菱、美的、无锡小天鹅、TCL 等

Xiangrong Mould specializes in manufacturing injection molds for household appliances such as washing machines and refrigerators, with over 20 years of production and design experience. Provide mold accessories for well-known home appliance brands at home and abroad. Currently, the main customers include Sharp, Panasonic, Haier, Whirlpool, Melling, Midea, Wuxi Little Swan, TCL, etc

**宁波新红方环保科技有限公司****N3-3A27****Ningbo Xinhongfang Environmental Protection Technology Co., Ltd**

地址: 浙江省宁波杭州湾新区滨海二路 173 号

电话 /Tel: 13968231910

宁波新红方环保科技有限公司主要经营净水设备、水处理设备、家用电器的研究、开发、制造、加工; 空气净化器、滤芯、金属制品、塑料制品制造、加工; 家用电器、净水设备。

**主要展品 /Products**

净水设备、水处理设备、家用电器的研究、开发、制造、加工; 空气净化器、滤芯、金属制品、塑料制品制造、加工; 家用电器、净水设备

**宁波轩畅电器有限公司****W2-2A14****NINGBO XUANCHANG ELECTRIC CO.,LTD**

地址: 浙江省慈溪市龙山镇筋竹村筋竹南路 25 号 (315331)

Add: NO.25 JINZHU SOUTH RD.,LONGSHAN TOWN,CIXI COUNTY,NINGBO,CHINA

电话 /Tel: 0574-63739585

传真 /Fax: 0574-63739585

网址 /Web: www.opnan.com

宁波轩畅电器有限公司坐落在杭州湾跨海大桥南岸浙江慈溪。公司凭借国际领先技术水平, 投入巨资从韩国引进水处理生产线、检测系统、近 20 台进口注塑机等设备, 多年来一直与国内、外净水企业在技术和贸易上通力合作, 产品出口巴西、东南亚以及欧美等国家。是国内知名净水企业的生产供应商。公司通过了 ISO9001 国际质量管理体系认证, 产品获得了国家 3C 安全强制认证、CE 欧盟认证并通过了卫生部门饮水卫生标准审核。

Ningbo Xuan Chang Electric Co., Ltd. is located in the south bank of Hangzhou Bay Bridge, Cixi, Zhejiang, China's largest water treatment equipment manufacturers. Companies with international advanced technology, invested heavily in the introduction of South Korea from the water treatment production lines, testing systems, nearly 20 sets of imported look-at-hand machines and other equipment, the products exported to South Korea, Brazil, Japan, Southeast Asia and Europe and the United States and other countries. Is the well-known water purification enterprises production suppliers. The company passed the ISO9001 international quality management system certification, the product has obtained the national 3C safety compulsory certification, CE



EU certification and passed the health department drinking water sanitation standards audit.

#### 主要展品 /Products

直饮净水机

DIRECT DRINKING WATER PURIFIER



eyunhome

#### 宁波一云电器科技有限公司

地址: 浙江省余姚市凤仪路 87 号

电话 /Tel: 86-574-22679000

E1-1A41 1A42

宁波一云电器科技有限公司, 是一家专注于手持吸尘器生产与销售为业务, 以自主研发生产 ODM 为经营模式的公司。

公司建立了以 ISO9000 质量体系为基础的标准化、制度化、程序化的管理体系, 以 ERP 信息管理系统为基础的准时、快速、高效的运营流程, 实现了客户满意度的最大化, 培养了大批忠实客户, 保持了业务的稳定发展。

#### 主要展品 /Products

手持吸尘器、家用吸尘器、车载吸尘器



#### 宁波易居海澳斯环保有限公司

#### NINGBO YIJU HAIAOSH TECHNOLOGY CO.,LTD

地址: 宁波北仑小港姚龙庵 71 号 (315000)

电话 /Tel: 0574-55223555

传真 /Fax: 0574-55223557

网址 /Web: WWW.ZJNBYJ.COM

N1-1A20

本公司专业研发和生产家用垃圾处理器, 产品因独特的外观设计以及新颖的功能开发而广受合作伙伴的认可。

#### 主要展品 /Products

公司主营家用厨余垃圾处理器产品



#### 宁波易科洛捷厨电有限公司

地址: 浙江省宁波市海曙区新桥 208 号 (315000)

电话 /Tel: 0574-87760262

传真 /Fax: 0574-87760262

N2-2B27 2B28

宁波易科洛捷厨电有限公司是国内专业的食物垃圾处理机制造商, 拥有完整自主的整机制造能力和尖端的直流永磁电机制造与控制相关技术, 数十项的发明及实用专利。2019 年公司建立了行业内第

一条全自动生产线, 实现年产 200 万台的生产能力。2020 年与中科院天津研究所和宁波大学共建厨余垃圾处理装备技术研究院, 现研究院拥有国家级人才在内的涉及环境工程, 机械工程与力学工程等各类专家 20 余人。

#### 主要展品 /Products

食物垃圾处理机及综合垃圾处理解决方案提供商



#### 宁波应拓科技有限公司

#### Ningbo Inventor Technology Co., Ltd.

地址: 宁波市奉化区莼湖街道翁岙村桐蕉司工业区

电话 /Tel: 13957414720

W4-4B50

宁波应拓科技有限公司专业生产即热式铸铝发热体, 广泛应用于可控式的热水和蒸汽发生, 如即热式热水器, 小厨宝, 咖啡机, 电蒸锅, 蒸烤箱, 挂烫机, 蒸汽拖把, 蒸汽清洗机, 蒸汽消毒机, 医用蒸汽消毒等。

应拓科技有全套生产设备, 通过了 ISO9001 生产管理体系, 有丰富的外贸出口经验。

应拓科技不仅能为您量身定做合适的发热体产品, 也可以进行整体系统的研发设计。

#### 主要展品 /Products

即热式铸铝发热体

die-casting heating element



#### 宁波盈兴电子科技有限公司

#### Ningbo Yingxing Electronic Technology Co., Ltd

地址: 浙江省宁波市鄞州区福明路 858 号恒富大厦 2 号楼 9 楼 (315043)

Add: 9 / F, building 2, Hengfu building, No. 858, fuming Road, Yinzhou District, Ningbo

电话 /Tel: 0574-88370182

传真 /Fax: 0574-87372929

E3-3A44 3A45

宁波盈兴电子科技有限公司是一家专业从事个人护理, 智能家居, 数码周边等产品的研发、生产、销售于一体的企业。旗下 SIWIEY 适印品牌定位于时尚精品, 以时尚、高品质、便捷、实用为品牌诉求点, 整体风格简约、时尚。每个产品的设计都融合现代时尚元素, 且具有很强的实用性, 更能体现使用人士新潮、前卫的完美形象。

Ningbo Yingxing Electronic Technology Co., Ltd. is an enterprise specializing in the R & D, production and sales of personal care, smart home, digital peripheral and other products. Siwiey's suitable printing brand is positioned as a fashion boutique, with fashion, high quality, convenience and practicality as the brand appeal point, and the overall style is simple and fashionable. The design of each product integrates modern fashion elements, has strong practicability, and can better reflect the fashionable and avant-garde perfect image of users.

#### 主要展品 /Products

冲牙器、电动牙刷、电动沐浴刷、硅胶洁面仪、折叠洗脚桶、三合一理容套装、手持电熨斗、手持挂烫机、负离子震动按摩梳、直发梳、护眼仪、腰腹仪、形体矫正器、颈部按摩仪、筋膜枪、负离子吹风机、便携式吸尘器、多功能护眼台灯、蓝牙闹钟音箱、蓝牙耳机、无线充、多功能化妆镜。

Tooth flushing device, electric toothbrush, electric shower brush, silica gel cleanser, folding foot washing bucket, three in one physiotherapy set, hand-held electric iron, hand-held ironing machine, negative ion vibration massage comb, straight hair comb, eye protector, waist abdomen instrument, body corrector, neck massage instrument, fascia gun, negative ion hair dryer, portable vacuum cleaner, multi-functional eye protection desk lamp, Bluetooth alarm clock speaker Bluetooth headset, wireless charger, multifunctional cosmetic mirror.



宁波永东电器有限公司

NINGBO YONGDONG ELECTRICAL APPLIANCE.CO,LTD

E3-3G86

地址: 浙江省宁波市溪口镇溪口工业区华盛路西门2号 (315502)

Add: NO.2 Huasheng Road, Xikou Industrial Zone, Xikou, Ningbo City, Zhejiang Province, China

电话 /Tel: 0574-82026300

传真 /Fax: 0574-88868523

宁波永东电器有限公司成立十余年,是一家专注于美发产品(卷发器/电夹板/电推)等研究、开发、生产及销售一体的生产型企业。旗下有“永东”、“婷萱”、“倩意”等品牌,公司现拥有的产品通过国家质量认证中心的3C质量体系认证,出口CE,ROHS等认证,拥有多款实用专利和外观专利,建有功能完备的检测中心,对产品进行严格的质量把控。

最好的产品、最好的服务、最好的信誉是我们永东电器一直以来的追求!

Ningbo Yongdong Electric Appliance Co., Ltd. has been established for more than ten years. It is a production enterprise focusing on the research, development, production and sales of hair products (hair curler/hair straightener /electric hair clippers). The products owned by the company have passed the 3C quality system certification of the National Quality Certification Center, export CE, ROHS and other certifications, and have a number of practical patents and appearance patents. It has established a testing center with complete functions to strictly control the quality of the products.

The best products, the best service and the best reputation have always been the pursuit of Ningbo Yongdong electric appliance!

#### 主要展品 /Products

卷发棒, 直发器, 卷直两用多功能, 折叠卷发棒, 折叠直发器, 自动卷发器, 吹风梳, 直发梳  
Hair curler, Hairstraightener, 2 in 1 Hair curler, Folding hair curler, Folding hair straightener, Automatic hair curler, Blowout brush, Hair straightening brush

# UCOME

宁波友康照明电器有限公司

NINGBO UCOME LIGHTING CO., LTD.

W5-5B47

地址: 余姚市梨洲街道竹山村邵家渡3号

电话 /Tel: 057462589818

宁波友康照明电器公司产品种类已超500种,既包括户外灯,也包括室内灯,拥有吸顶灯,壁灯,草坪灯,射灯等各类灯,其中压铸类灯成为公司特色。目前公司主要市场集中在欧洲,在欧洲已拥有4个设计团队。公司自成立以来,便始终注重研发,友康人始终秉持创新就是第一动力的精神,在照明行

业中已申请拥有200余种专利,包括灯具外观设计以及照明装置等,充分体现了友康人积极进取,开拓创新的精神。

#### 主要展品 /Products

充电类灯具

# YUTON

宁波余通电器有限公司

NINGBO YUTONG ELECTRIC APPLIANCE CO.,LTD

E3-3D71 3D72

地址: 浙江省余姚市临山镇湖堤村 (315460)

电话 /Tel: 13566085487

宁波余通电器有限公司成立于2000年,坐落于浙江省宁波余姚市。我司专业生产车载小冰箱,压缩机冰箱,制冰机。

#### 主要展品 /Products

车载冰箱,压缩机冰箱,制冰机

# 云节

宁波云上智能科技有限公司

NingBo YunShang Intelligent Tehnology Co., LTD

E1-1A15

地址: 浙江省慈溪市 (315301)

Add: No.69 Zongyi Road,ChaoTang Industrial,ZongHan Street,CiXi City,ZheJiang,China

电话 /Tel: 13245523548

传真 /Fax: 0574-63269278

网址 /Web: www.nb-yszn.com

宁波云上智能科技有限公司位于位于美丽富饶的杭州湾畔——宁波慈溪市潮塘工业区,宁波港、宁波机场等便利的交通运输保证及时的交货期。公司主要生产经营智能清洁消毒产品。

本着创新、发展、服务社会的宗旨,“云上智能”坚持“诚信为本,客户至上”的宗旨,本着“品质为本,精益求精”的经营理念,力求给客户id提供全方位优质服务的同时,也使企业得到长远的发展。期待与各位业界新老客户携手共进,共创辉煌。

NingBo Yunshang Intelligent Technology Co.,Ltd is located in beautiful and rich Hangzhou Bay——chaotang industrial Zone,CiXi,NingBo.The sea and land transportation are very convenient.Ningbo port, Ningbo airport and Hangzhou Bay Bridge are directly connected to Shanghai.Convenient transportation and open conditions will ensure timely delivery..Our company mainly produces household appliances.

In line with the purpose of innovation,development and social services,“cloud intelligent” hopes to lead the industry at the top;adhere to the “integrity-based,customerfirst” surpose,in the line “quality-oriented,excellence” business sales philosophy,strive to provide customers with all-round high-quality services,but also make the enterprise get considerable development.We are looking forward to working together with new and old customers to create brilliant future.

#### 主要展品 /Products

多功能蒸汽拖把、洗地机、拖地机、电吹风、卷发棒、直发梳

**宁波泽源电器有限公司****E3-3A37****Ningbo Zeyuan Electrical Appliance Co., LTD.**

地址: 浙江省宁波市慈溪市周巷镇大古塘村芦庵路 45 号 (315300)

电话 /Tel: 86-574-58969197

传真 /Fax: 86-574-63316051

网址 /Web: www.nbzeyuan.com

宁波泽源电器有限公司成立于 2010 年, 坐落于浙江慈溪, 专业生产个人护理类产品, 主要产品有吹风机, 直发器, 卷发棒, 热风梳等。公司发展 10 年有余, 员工大概有 250 人左右, 有自己的注塑部门和机芯部门, 三条生产线以及一条包装线。目前主要出口国家有巴西, 俄罗斯, 美国, 法国, 英国等。秉承着“品质即为生命”的原则, 公司会全心全意服务好每一个客户以及重视每个客户的产品。

Established in 2010, Ningbo Zeyuan Electrical Appliance Co., Ltd. is engaged in design, manufacturing and marketing high quality hair care & styling products as well as plastic led candles. Zeyuan is located in Cixi City with 2 hours' driving distance to Shanghai and Ningbo. The factory covers over 14,000m<sup>2</sup> with more than 250 employees, including many experienced engineers to provide total solutions for OEM/ODM projects. Zeyuan has a full set of production equipments: Tooling Workshop, Injection Workshop, Dust-Free Spray Plant and Silkscreen Workshop. As an ISO 9001:2000 quality assurance certified company, Zeyuan always makes continuous improvement on every aspect and always believe the quality should be given the first priority.

**主要展品 /Products**

电吹风, 直发器, 卷发棒

hair dryer, hair straightener, hair curler

**宁波哲恺电器有限公司****E1-1B33 1B34****NINGBO ZHE KAI ELECTRIC APPLIANCE CO., LTD**

地址: 浙江省宁波慈溪桥头镇桥头路 610 号 (315317)

Add: NO.610 QIAOTOU ROAD, QIAOTOU TOWN, CIXI, NINGBO, CHINA

电话 /Tel: 86-574-63616127

传真 /Fax: 86-574-63616127

网址 /Web: www.i-hassan.com

宁波哲恺电器有限公司, 一家专业生产空气净化器和吸尘器的工厂, 位于宁波慈溪桥头镇, 在空气净化和吸尘器领域有 10 多年的制造经验。

We, Ningbo Zhe Kai Electric Appliance Co., Ltd established in 2004, a professional manufacture of home appliance.

In 2012, we start air purifier project. Now we have 300 staffs with more than 45,000 square meters of built area.

Our product range are Air Purifier and Vacuum Cleaner. Innovative design, reliable performance, high quality and competitive price, our products are selling well in the world.

**主要展品 /Products**

空气净化器, 吸尘器, 挂烫机

Air purifier, vacuum cleaner and garment steamer



中国 制造 乐享生活

**宁波中乐环保科技有限公司****N3-3B17**

地址: 浙江省慈溪市新浦镇经二路 111 号

电话 /Tel: 18606626164

宁波中乐环保科技有限公司是一家专业生产和销售即热式管线饮水机直饮机系列产品的高新技术企业。公司始终秉承 [ 不断超越客户需求, 追求客户满意服务 ] 的精神, 综合现代科技及未来趋势, 发挥整体团队创造力, 以服务客户为导向, 并根据各地不同的水质情况, 创导标准制水方式和多项科学技术相组合的终端饮用水解决方案。壮大凭籍其强大的设计开发能力, 完善的产品改进机制, 可靠的品质保障能力, 快速反应的售后系统。

**主要展品 /Products**

速热管线饮水机, RO 纯水机, 商用机。

NEOPERL®

flow, stop and go®

**纽珀水暖配件 (上海) 有限公司****E3-3A13**

地址: 上海市徐汇区东湖路 9 号 20 楼 (200031)

电话 /Tel: 021-62889390

传真 /Fax: 021-62889391

网址 /Web: <https://www.neoperl.com/global/en/home/>

纽珀集团是一家德国—瑞士联合企业, 提供与水暖、卫浴和净水行业相关的创新解决方案。帮助客户塑造水形之美, 稳定出水流量, 有效保护宝贵的水资源。

纽珀是一家面向全球市场的国际化集团公司, 研发和生产总部在德国的米尔海姆, 营销中心位于瑞士的巴塞尔。集团在欧洲、亚洲和美洲共有 12 个生产基地。

纽珀集团提供丰富的产品系列来满足客户的个性化需求, 包括: 起泡器、流量调节器、止回阀、软管、分水器和功能配件等。

**主要展品 /Products**

起泡器、流量调节器、止回阀、连接软管、沐浴软管、厨房抽拉管、分水器和功能配件等

**诺凡赛尔 (上海) 保护膜有限公司  
Novacel (Shanghai) Co., Ltd****N3-3B47**

地址: 上海市松江区泗泾工业二区九干路 179 号 (201601)

Add: No.179 Jiugan Road, Sijing, Songjiang, Shanghai

电话 /Tel: 021-57617568

传真 /Fax: 021-57617445

网址 /Web: [www.novacel-solutions.com](http://www.novacel-solutions.com)

诺凡赛尔是法国露日集团旗下的负责保护膜业务的专业公司, 是临时表面保护领域的全球领导者。诺凡赛尔遍布五大洲, 为 90 多个国家和地区的 3000 多家客户提供量身定制的产品和服务。诺凡赛尔在工业表面保护, 技术胶带, 涂料和机械等方面拥有 40 多年的经验。

Novacel is a professional company responsible for the protective film business under the French Chargeurs group. It is a global leader in the field of temporary surface protection. Novacel's business covers five continents and provides customized products and services to more than 3000 customers in more than 90 countries and regions. Novacel has more than 40 years of experience in industrial surface protection, technical tape, coating and laminator.

#### 主要展品 /Products

氧系列保护膜, 蓝色透明保护膜 4513, 黑白保护膜 4223, 激光膜切割保护膜 4228REF  
Oxygen Range Film, Blue Transparent Film 4513, Black & White Film 4223, Laser Cutting Film 4228REF



#### 帕恩检测技术(杭州)有限公司 Pioneer Testing Technology (Hangzhou) Co., Ltd

N3-3B55

地址: 杭州市临平区顺风路 536 号 41 幢 401  
电话 /Tel: 057186375969  
网址 /Web: http://www.pnt-lab.com/

PNT 帕恩检测, 成立于 2012 年, 是一家集检测、认证、验厂验货、技术支持为一体的第三方检测认证机构。检测认证能力覆盖灯具、家电、开关插座等电子电器产品, 玩具、纺织品、皮革制品、鞋类等轻工消费产品, 钢卷、门窗、瓷砖等建材制品, 花洒、马桶、等卫浴产品, 以及化妆品、食品等产品的检测认证能力, 全方位为客户提供一站式的检测认证服务。

Pioneer Testing Technology, Established in 2012, it is a third-party testing and certification organization integrating testing, certification, factory inspection and technical support. The testing and certification capabilities cover electronic and electrical products such as lamps, home appliances, switches and sockets, light industrial consumer products such as toys, textiles, leather products, and footwear, building materials such as steel coils, doors and windows, tiles, showers, toilets, and other sanitary products, and The testing and certification capabilities of cosmetics, food and other products provide customers with one-stop testing and certification services in an all-round way.

#### 主要展品 /Products

家电产品: 吸尘器; 电熨斗; 洗衣机; 干衣机; 电烤箱、烤架、三明治炉、华夫饼炉; 保温板; 深油炸锅、油煎锅; 厨房机械器具(搅拌机、榨汁机、面条机); 电饭锅、电水壶、咖啡机; 食品垃圾处理; 微波炉; 充电器; 贮水式电热水器、小厨宝; 制冷器具、冰淇淋机、冰箱、冰柜; 风扇、换气扇; 理发器、剃须刀; 室内加热器; 按摩器具; 口腔护理器具(电动牙刷)等。

Household appliances: vacuum cleaners; Electric iron; Washing machine; dryer; Electric oven, grill, sandwich oven, waffle oven; Insulation board; Deep frying pan, frying pan; Kitchen machinery and appliances (blenders, juicers, noodle machines); Electric rice cooker, electric kettle, coffee machine; Food waste disposal; Microwave Oven; Charger; Water storage electric water heaters, small kitchen utensils; Refrigeration appliances, ice cream machines, refrigerators, freezers; Fans, ventilation fans; Barbers, razors; Indoor heater; Massage appliances; Oral care appliances (electric toothbrush), etc.

primitalia

#### 浦美泰 primitalia

N3-3A21 3A22 3A23

地址: 广州市天河区黄埔大道西平云路 163 号广电科技大厦 201 自编之 201 单元场地  
Add: UNIT 201, GuangDian Technology Building, No.163 PingYun Rd. TianHe District, GuangZhou, China  
电话 /Tel: 02038858999  
传真 /Fax: 86-20-38858333  
网址 /Web: www.primitalia.cn

秉持着传统意大利匠人的精神, 秉承“国际视野, 无与伦比”的设计理念, 研发了全球最小的磨豆咖啡机, 首创冷热两用咖啡。拥有超过 50 项的发明专利、实用新型专利及外观专利, 为国家“高新技术企业”。

#### 主要展品 /Products

咖啡机, 料理机, 电热水杯, 电热水瓶, 即热式饮水机, 烤箱等

HDL

#### 普林特新材料(中山)有限公司 Guangdong Shunde Huidelong New Material Co., Ltd

N4-4B25

地址: 佛山市顺德区伦教新塘世龙大道 13 号 A  
电话 /Tel: 13322902699

我司于 2015 年成功开发高端岩板工艺。应用市场: 广泛用于家电岩板玻璃、家具衣柜、橱柜装饰、岩板玻璃。由于该产品具有无法替代的特殊性能而深受广大客户的喜爱! 高端岩板玻璃工艺采用高精度丝网印版多层印刷, 采用特殊性能岩板油墨涂加工而成。且可做透明视窗, 耐候性好, 颜色还原性好, 高温烧成不变色, 涂层具有可永久性。有凹凸手感给你完全不一样的视觉感受。

#### 主要展品 /Products

我司于 2015 年成功开发高端岩板工艺。应用市场: 广泛用于家电岩板玻璃、家具衣柜、橱柜装饰、岩板玻璃。由于该产品具有无法替代的特殊性能而深受广大客户的喜爱! 产品具有硬度高(可达 5~6H 可以达到玻璃硬度)、不烧油、耐水煮、耐高温、耐酸、耐抗等特点, 化学性能优秀! 抗冲击性好, 易清洁。且可做透明视窗, 耐候性好, 颜色还原性好, 高温烧成不变色, 涂层具有可永久性。有凹凸手感给你完全不一样的视觉感受。

protecfire  
German Engineering

#### 普泰法尔(廊坊)消防科技有限公司 Protecfire (Langfang) Fire Systems Technology Co., Ltd.

N2-2A18

地址: 河北省廊坊市固安县 新兴产业园区卫星导航产业园 8 号楼 2 单元  
Add: 11 Changji North Street 1 #03-08 Singapore 498823  
电话 /Tel: 0316-5929119  
传真 /Fax: 0316-5922569



网址 /Web: <https://protecfire.com.sg/>

Protecfire 创建于 2001 年, 总部位于德国, 是一家专注于自动灭火系统研发、生产和销售的企业, 是世界首家利用精细喷淋技术研发出纯机械自动灭火系统的公司。已通过德国 DMT、VDS 等十几个认证。产品主要应用于厨房、重型移动设备、巴士、风电、新能源和国防等领域。2019 年在中国成立了第一家工厂 - 普泰法尔(廊坊)消防科技有限公司, 致力于全面服务中国市场, 并作为独立的生产线将产品远销到全球市场。

#### 主要展品 /Products

公司主要有 firetubex 家庭厨房自动灭火系统、firespy kitchens 商业厨房和工业炸锅自动灭火系统以及船舶、风电、电控柜、道路车辆自动灭火系统等产品。

## Transtar®

### 勤耕云智能科技(深圳)有限公司 Shenzhen Transtar Electronics Co., Ltd.

E2-2A04

地址: 深圳市宝安区松岗街道潭头盈丰工业园 1 栋 (518000)

电话 /Tel: 13641452929

网址 /Web: [www.transtar-av.cn](http://www.transtar-av.cn)

深圳市全顺达电子有限公司成立于 2003 年, 公司产品涵盖智能擦窗机器人、智能洗地机、智能扫地机器人等, 成为集研发、销售、生产和服务于一体的现代高科技企业。公司拥有一支经验丰富的研发设计团队, 自有塑胶模具部、注塑部、喷涂部、SMT 部、组装部等标准厂房和配套设施近 20000 平方米; 证书包括: 国家高新技术企业证书、ISO9001、ISO14001 等等, 并拥有多项国际发明及实用性专利。

#### 主要展品 /Products

智能擦窗机器人、智能洗地机、智能扫地机器人等

Window cleaning robot, Wet and Dry vacuum cleaner, Smart vacuum cleaner



QINGDAO DADONG

### 青岛大东电子有限公司 QINGDAO DADONG ELECTRONICS CO., LTD.

N4-4A26

地址: 青岛平度市同和路 7 号 (266706)

Add: NO.7 Tonghe Road, Pingdu, Qingdao City, Shandong Province, 266706 China

电话 /Tel: 13573236216

传真 /Fax: 87311241

网址 /Web: [www.dadonglogo.com](http://www.dadonglogo.com)

青岛大东电子有限公司成立于 1995 年, 坐落于山东省青岛平度市同和工业园, 距离青岛机场 40 分钟, 建筑面积 19600 平方米, 交通便利。公司为韩国独资企业, 注册资本 375 万美元。到 2023 年, 公司已踏实走过 28 个春秋, 公司拥有电镀、蚀刻、氧化、真空镀、激光、喷漆等各种表面处理产线, 可进行标牌, 其他金属物以及素材多样的制造加工工程, 是集研发、设计、生产、服务的一站式生产企业。

Founded in 1995, Qingdao Dadong Electronics Co., Ltd. is located in Tonghe Industrial Park, Pingdu City, Qingdao, Shandong Province, 40 minutes away from Qingdao Airport, with a construction area of 19600 square meters and convenient transportation. The company is a

wholly Korean enterprise with registered capital of 3.75 million US dollars. By 2023, the company has been practical through 28 spring and autumn, the company has electroplating, etching, oxidation, vacuum plating, laser, spray painting and other surface treatment production line, can carry out signs, other metal and materials of a variety of manufacturing and processing engineering, is a collection of research and development, design, production, service one-stop production enterprises.

#### 主要展品 /Products

金属标牌: 镍超薄金属标牌、铜超薄金属标牌、镍电铸标牌、铝标牌、不锈钢标牌、PET 标牌。

Metal signs: nickel ultra-thin metal signs, copper ultra-thin metal signs, nickel electroforming signs, aluminum signs, stainless steel signs, PET signs.

## QDHB

### 青岛鸿博新能源有限公司 Qingdao Hongbo New Energy Co., Ltd.

W5-5B44

地址: 山东省青岛市平度经济开发重庆路 265 号

Add: No.265 Chongqing road Pingdu City Shandong Province P.R.China

电话 /Tel: 13210055820

青岛鸿博新能源有限公司, 主要从事 18650、32700 等锂离子电池、电池组的研发、生产、销售及售后服务。公司产品寿命长、安全性好, 主要应用于太阳能路灯、家用电器、户外照明、UPS 电源等, 我们的优势: 我们有电芯厂现场工艺、技术认证的能力; 电芯产品质量管控与改善能力; 可为客户提供安全且高性价比的产品。公司将坚决贯彻“质量第一, 客户至上”的宗旨, 竭诚为客户提供具有竞争力价格的高品质的产品。

#### 主要展品 /Products

锂离子电池

Li-ion battery



### 青岛杰生电气有限公司 Qingdao Jason Electric Co., Ltd.

W4-4B32

地址: 青岛市崂山区科苑纬四路 102 号 (266000)

电话 /Tel: 18562630763

传真 /Fax: 053288705927

网址 /Web: [www.qdjason.com](http://www.qdjason.com)

青岛杰生电气有限公司成立于 2001 年, 国家级高新技术企业, 专注于紫外 LED 产品以及 GaN-MOCVD 高端外延设备的研发、生产和应用, 是国内尖端半导体器件技术企业, 注册资本 1.58 亿元。

#### 主要展品 /Products

深紫外 led 杀菌系列产品



### 青岛朗兹环保科技有限公司

W2-2H71

#### Qingdao Londs Environmental Protection Technology Co., LTD.

地址: 山东省青岛市城阳区东旺疃工业园 (266109)

Add: Dongwangtuan Industrial Park, Chengyang District, Qingdao city, Shandong Province

网址 /Web: www.londs.cn

青岛朗兹环保科技有限公司, 成立于 2014 年, 是一家以专业设计、研发、生产和销售空气净化设备为主的环保设备服务公司, 主要产品有家用空气净化器、空气消毒机、新风系统及恒温恒湿机等。

公司位于山东省青岛市。目前公司通过了 ISO9001、ISO14001、ISO45001 等体系认证, 并获得了众多国内外名企的供应商资质, 具备良好的管理体系和供货能力。通过与众多国内外客户的合作, LONDS 的产品遍及海内外。

Qingdao Londs Environmental Protection Technology Co., LTD., founded in 2014, is mainly engaged in the design, research and development, production and sales of air purification equipment.

The company is located in Dongwangtuan Industrial Park, Chengyang District, Qingdao, the main products include household air purifier, air disinfection machine, fresh air system, constant temperature and humidity machine, personal care appliances, etc.

The company has perfect independent design and system development capabilities, and won the title of National High-tech Enterprise in 2018.

At the same time, the company has advanced product manufacturing capacity and improve the quality management system, through the ISO9001, ISO14001 and ISO45001 system certification.

#### 主要展品 /Products

家用空气净化器、空气消毒机、新风系统、恒温恒湿机、个人护理电器等。

Household air purifier, air disinfection machine, fresh air system, constant temperature and humidity machine, personal care appliances, etc.



欧亚美化学  
Ou Ya Mei Chemistry

### 青岛欧亚美化学科技发展有限公司

N1-1A46

#### Qingdao Eurasia-American Chemical Technology Development Co., Ltd

地址: 中国 (山东) 自由贸易试验区青岛片区龙岗山路 51 号

Add: 51 Longgang Road, Qingdao Area, China (Shandong) Pilot Free Trade Zone

电话 /Tel: 18678975695

网址 /Web: www.qdouyamei.com

青岛欧亚美化学科技发展有限公司成立于 2015 年, 注册资金 600 万。是一家集研发、生产、销售为一体的现代化环保型清洗剂生产型企业。公司拥有专业研发团队, 以“创新科技, 追求与自然和谐共处”的公司精神, 不断研发更新高效、环保、安全的产品, 满足清洁市场更加便捷、安全的需求。为稳定产品质量产品全部采用全自动生产工艺, 日产能 10 万件, 并通过了 ISO9001 质量体系认证, 可以为客户提供 OEM 服务。

#### 主要展品 /Products

(一) 日化清洁用品

## 参展商名录 (按字母排序) / Alphabetical List of Exhibitors

油烟机清洁保养剂, 百洁膏、多用途家居清洁剂、多用途家居除垢剂、小白鞋清洗剂、羽绒服清洗剂等, 日用清洁用品。

(二) 家电清洗专用清洁养护用品

油烟机清洁剂、重油污清洁剂、洗衣机清洁剂、太阳能除垢剂、热水器除垢剂、硅胶除霉剂等十几个产品。主要面向国内的专业的保洁公司、家电清洗公司。该系列产品为海尔日日顺、海信赛维、京东、苏宁、国美等家电服务平台提供 OEM 服务。



### 青岛瑞智机电销售有限公司

W2-2G61

#### Qingdao Rechi Electric Machinery Sales Co., Ltd.

地址: 山东省青岛市黄岛区奋进路 500 号瑞智精密

Add: No.500 Fenjin RD, Huangdao District, Qingdao, Shandong Province, China. Company

电话 /Tel: 15954212558

网址 /Web: https://www.rechi.com/

瑞智精密成立于 1989 年, 为全球回转式压缩机领导品牌, 坚持「质量至上」理念, 提供「顾客满意」产品和服务, 压缩机年产能达 2,600 万台, 产品已扩及直流变频空调、北美单元式空调、移动式空调、窗型空调、除湿机、热泵干衣机、热泵热水器、宠物空调等领域。

「追求企业价值极大化、善尽爱护地球的企业责任」为使命, 并兼顾地球环境与资源, 与国际知名企业建立战略合作伙伴关系, 一起创建环保未来世界!

RECHI was established in 1989 and became the world's fourth largest rotary compressor leader brand. We believe that "Quality Superiority" and "Customer Satisfaction" with our products and services are the key to success over of RECHI, RECHI Group now has annual compressor capacity of 26 million sets. Presently our product has expanded the applications in fields such as DC inverter A/C, Unitary A/C, Portable A/C, Window type A/C, Dehumidifier, Heat Pump Dryer, Heat Pump Water Heater, Heat Pump Washing Machine and Pet A/C.

We have kept "To pursuit the maximization of enterprise value" & "To fulfill the responsibility of caring the Earth" as corporate mission to watch over both the environment and resource. Also establishes good relationship of strategic partners with global well-known enterprises to create the green future together.

#### 主要展品 /Products

产品特色:

1. 高效化: 满足北美空调及除湿机能效标准、欧洲干衣机 A+++ -20% 能效标准、日本空调领跑者计划、中国空调新国标一级能效标准等各国最高能效标准。
2. 静音化: 追求降噪极致, 进行结构、声学、流体噪音分析设计取得多项专利。
3. 小型化: 以变频、高频化, 实现产品小型化。
4. 应用多元化: 应用于直流变频空调、北美单元式空调、移动空调、窗型空调、除湿机、热泵干衣机、热泵热水器、宠物空调等。

Product's characteristics:

1. Our compressors can meet A/C and Dehumidifier from Energy Star Label in USA, Heat Pump dryer from A+++ -20% in EUROPE, BEE label Five Star Energy Star Rating in INDIA A/C, Top runner in JAPAN A/C, New Energy Label Tier 1 Rating in CHINA A/C the various international energy efficiency standards.
2. Low Noise: To pursue extremely low noise levels, We focus Structural analysis and design,

Acoustic analysis and design, Flow noise analysis and design, and have attained various patents and implemented the innovative techniques.

3. Compact Size: RECHI has implemented these requirements and satisfied customers' demands through the evolutionary techniques of frequency conversion and high efficiency.
4. Multi-Application: Multi-Application for Air Conditioners, Dehumidification & Drying, Heating and Mobile & Personal living Comfort, Pet Air Conditioners.



**青岛拓普斯智能科技有限公司**

**Qingdao Tuopusi Intelligent Technology Co.,Ltd.**

地址：青岛市城阳区铁骑山路 299 号玉皇岭工业园 (266100)

Add: No, 299 yuhuangling industrial park, tieqishan road, chengyang district, qingdao city, China

电话 /Tel: 18753288003

传真 /Fax: 0532-66851265

网址 /Web: www.toppsen.cn

青岛拓普斯智能科技有限公司于 2010 年成立，注册资金 3000 万。坐落于美丽的海滨城市青岛，现拥有两个生产装配车间，总面积达 8000 平方米。

公司专业从事自动化铆接设备及焊接生产线、钣金自动化设备及生产线、包装自动化设备及生产线的设计研发、生产制造以及安装调试一条龙服务，服务于家电行业的的洗衣机、热水器、空调、冰箱、洗碗机、烤箱、油烟机、等自动化线体领域。

Qingdao tuopusi intelligent technology co., ltd. was founded in 2010 with a registered capital of 30 million RMB. It is located in the beautiful coastal city of Qingdao, Now our company has two production and assembly workshops with a total area of 8000 square meters.

Our company specializes in design ,development, manufacturing and installation of automatic clinching equipment and welding production line, sheet metal automation equipment and production line, automatic packaging equipment and production line . all the lines will be used for the area of washing machine, water heater, refrigerator,dish washer,oven, range hood ....

Our company has passed ISO9001 quality system certification, and obtained a number of intellectual property standards of high-tech enterprises.

#### 主要展品 /Products

自动化铆接设备及焊接生产线、钣金自动化设备及生产线、包装自动化设备及生产线的设计研发、生产制造以及安装调试一条龙服务，服务于家电行业的的洗衣机、热水器、空调、冰箱、洗碗机、烤箱、油烟机、等自动化线体领域。

automatic clinching equipment and welding production line, sheet metal automation equipment and production line, automatic packaging equipment and production line . all the lines will be used for the area of washing machine, water heater, refrigerator,dish washer,oven, range hood ....

**N4-4B15 4B16 4B17**



**青岛萤光创新科技有限公司**

地址：青岛市城阳区祥阳路 106 号

电话 /Tel: 18094235836

青岛萤光创新科技有限公司由博士后团队创立于 2017 年 3 月，专业的管理研发团队依据客户提出的各类技术需求，交互后提供相应的品质可靠的产品设计方案。公司专注于 UV LED 应用技术研究提供 ODM、OEM 专业解决方案，客户应用领域有：分析检测、光化学催化、防伪检测、通讯定位及消毒杀菌等领域，客户主要产品包括：空气与水质分析检测仪、消毒灭菌类健康产品、工业与科研级紫外模块、定制化的紫外系统解决方案。

#### 主要展品 /Products

UVC LED 深紫外杀菌模组

**N3-3A32**



**沃尔特赫恩**

**青岛沃尔特赫恩电子科技有限公司**

**QINGDAO WALTERHEEN ELECTROIRC TECHNOLOGY CO.LTD**

地址：山东省青岛市城阳区前金工业园 8 号

电话 /Tel: 0532-87692899

青岛沃尔特赫恩电子科技有限公司，专注于健康舒适睡眠领域。

总部坐落于美丽的滨海城市-青岛，园区占地面积三万余平，厂房建筑面积两万余平，是一家集研发、生产、销售、服务四位一体的专业化水暖床垫制造企业，自主年产能百万台水暖主机。

自品牌创建以来坚持以舒适助眠产品为导向，产品包括智能恒温水暖床垫，智能变频冷暖两用水暖主机等多个项目板块，获得了几十项专利、CE 等多项电器安全认证、ISO 等多项管理体系认证，致力于将舒适健康的睡眠方式传递至全球，争创世界民族品牌。

#### 主要展品 /Products

水暖毯

**W1-1A55 1A56**



**清洋流体科技 (上海) 有限公司**

**Cinyar Fluid Technology (Shanghai) Co., Ltd**

电话 /Tel: 18550243446

网址 /Web: www.cinyar.cn

清洋流体秉承了“以客户为尊”的经营理念，“让所有客户都能用上好泵”的企业愿景，专攻于泵（蠕动泵，隔膜泵），管，阀三大主航道业务，并积极参与医疗，智能家居，现代化农业等创新领域，用“满意+惊喜”的高品质服务赢得客户的广泛认可。

**W1-1A42 1A43**

**主要展品 /Products**

清洋流体秉承了“以客户为尊”的经营理念，“让客户都能用上好泵”的企业愿景，专攻于泵（蠕动泵，隔膜泵），管，阀三大主航道业务，并积极参与医疗，智能家居，现代化农业等创新领域，用“满意 + 惊喜”的高品质服务赢得客户的广泛认可。

**锐莫 (佛山) 电器科技有限公司****RIMOO (FOSHAN) ELECTRICAL APPLIANCE TECH CO., LTD****E2-2A22**

地址：广东省佛山市顺德区北滘镇创业园 4 栋 5 楼 (528300)

Add: No. 25th, Sanle East Road, Beijiao Town, Shunde, Foshan, Guangdong, China

电话 /Tel: 13016068519

传真 /Fax: 29322892

网址 /Web: www.rimoo.com.cn

锐莫 (佛山) 电器科技有限公司，一家创新的家电产品公司。我们的产品范围涵盖小型厨房电器和环保电器，如空气加湿器、吸尘器、空气炸锅。我们的产品通过了多种标准认证，包括 CE、CB、ETL、SASO、Rohs、FDA、LFGB 等。我们的团队成员在家电研发、营销、产品等领域拥有超过 15 年的综合经验开发和制造。我们对国内市场和技术趋势有着深刻的理解，并且在为国际市场开发家电方面有着长期的经验。

We Rimoo (Foshan) Electrical Appliances Tech. Co., Ltd, an innovative home appliance product company based in Shunde, the center of the home appliance supply chain in China. Our product range covers small kitchen appliances and environmental appliances, such as electric water bottle pumps, air humidifier, vacuum cleaner. We have products certified to a wide variety of standards, including CE, CB, ETL, SASO, Rohs, FDA, LFGB, etc.

Our team members have more than 15 years experience in the fields of home appliance R&D, marketing, product development, and manufacturing. We have a deep understanding of the domestic market and technical trends, as well as long experience in developing home appliances for the international market. We are dedicated to providing not only a quality product at a competitive price, but also business relations and support to allow us to grow and develop business together.

**主要展品 /Products**

吸尘器、加湿器、空气炸锅

Drum vacuum cleaner, Air Humidifier, Air fryer oven



Shrieve

**瑞孚化工 (上海) 有限公司****Shrieve Chemical (Shanghai) Ltd****W2-2A25 2A26 2A27**

地址：上海市徐汇区平福路 188 号聚鑫高科技园 2 号楼 3 楼 (200231)

Add: 3F, Bldg 2, JUXIN HI-TECH Park, No.188 Ping Fu Road, Shanghai

电话 /Tel: 21-63598216

传真 /Fax: 21-63524607

网址 /Web: shrieve.com.cn

瑞孚化工集团公司成立于 1978 年，公司涉及的业务领域有：有机及无机化学品、合成环保型润滑油、增塑剂、环保型油田化学品等。在所涉业务领域，瑞孚公司组建了服务团队，并与其他石油化工企业实现了强强合作。瑞孚公司作为制冷压缩机润滑油供应商，拥有丰富的产品系列，是主要的烷基苯冷冻机油供应商。

Shrieve Chemical Group was founded in 1978, its headquarters was set up in Houston, USA; involved business area includes: Organic and inorganic chemicals, synthetic eco-friendly lubricants, plasticizer, eco-friendly oil field chemicals. In the involved business area, Shrieve has the most excellent technical experts in the world, through cooperation between global petrochemical giants, rapidly becomes the most professional and leading supplier and service provider.

**主要展品 /Products**POE 制冷压缩机润滑油, PAG 制冷压缩机润滑油, 烷基苯制冷压缩机润滑油  
polyolester compressor oil, PAG refrigerator oil, alkylbenzene refrigerator oil**瑞是达电子贸易 (上海) 有限公司****RESTAR ELECTRONICS (SHANGHAI) CO.,LTD.****N4-4A06**

地址：上海市黄浦区淮海中路 222 号力宝广场 1701 室 (200021)

Add: Rm.1701, Lippo Plaza, 222 Huaihai Zhong Road, Huangpu District, Shanghai, China

电话 /Tel: 021-53965511

传真 /Fax: 021-53965512

网址 /Web: www.restarip.com

我司代理日本 Kaltech Co. 公司的产品，该公司开发和销售配备该公司专有的光催化技术的产品，可以分解病毒和异味。该公司由一家大型电力设备制造商的前工程师于 2018 年 2 月成立。理念是“让世界上每个人都能享受到光催化剂的好处”。该公司目前在日本全国范围内销售其自有品牌的空气净化器 and 除臭器，用于日本家庭、餐馆、医院和公共设施，具有日本制造的品质。

Kaltech Co., a Japanese venture company developing and selling products equipped with the company's proprietary photocatalytic technology that decomposes viruses and odors. The company was established in February 2018 by a former engineer of a major electric equipment manufacturer. The company's philosophy is "make the benefit of photocatalysts available to everyone in the world." The company currently sells its own brand of Air purifier and deodorizers for Japanese homes, restaurants, hospitals, and public facilities with made-in-Japan quality throughout the country.

The company will debut their product lineup of purifiers and deodorizers for air purification at APPLIANCE & ELECTRONICS WORLD EXPO. Using cutting edge technology, Kaltech is improving the safety of our air, water and food for generations to come.

**主要展品 /Products**光触媒空气净化器, 车载空气净化器, 光触媒消毒箱, 常温食品保鲜盒, 可携带空气净化器  
Air Purifier





## 瑞昱半导体

### Realtek Semiconductor Corp.

W4-4F81

地址: 台湾新竹科学园区创新二路 2 号 (30076)

Add: No. 2, Innovation Road II, Hsinchu Science Park, Hsinchu 300, Taiwan

电话 /Tel: 88635780211

传真 /Fax: 88635773449

网址 /Web: <https://www.realtek.com/zh/>

瑞昱半导体是全球顶尖的 IC 供应商之一, 拥有 35 年经验于研发设计有线及无线通讯网络、电脑周边和多媒体应用等各种 IC 产品。从城市网路基础设备、IoT 智能家庭到个人穿戴科技, 致力提高人们生活品质。瑞昱是拥有 RF、类比和混合讯号回路领域的先进设计专家, 还有优异的制造与系统知识, 为客户提供全功能、高效能而且具有竞争力的整体解决方案。

Realtek provides IC solutions for communications networks, computer peripherals, and multimedia devices. For 35 years, our wired & wireless technology have facilitated connections and communications between people and their device; facilitating progress toward enriched, high-quality living.

Products include 10/100/1000/2500M Ethernet Controllers/PHYs, 10/100/1000M/2500M/10G Ethernet Switch Controllers/Media Converter Controllers/Gateway Controllers, Wireless LAN Controllers & AP/Router SoCs, xDSL, VoIP Solutions, Bluetooth, xPON, IoT Solutions, Automotive Ethernet Solutions, High Fidelity Audio Solutions for Consumer and PC Applications, Card Reader Controllers, Web/IP Camera Controllers, LCD Monitor/ATV/DTV Controllers, and Digital Home Center Controllers. With advanced design expertise in RF, analog, and mixed signal circuits, and with strong manufacturing and system knowledge, Realtek offers full-featured, high-performance, and competitive total solutions.

#### 主要展品 /Products

##### 通信网络应用

- 车用以太网网络交换机 /PHY
- 交换机 / 闸道器控制芯片
- xDSL/xPON 控制芯片
- Wi-Fi/ 蓝牙 /IoT 控制芯片

##### 联网多媒体应用

- 以太网网络 /PHY
- 数字机顶盒 /OTT 控制芯片

##### 电脑周边应用

- 消费电子 / 电脑音讯 / 网络监控 / 电脑摄影机控制芯片
- Hub/Type-C/ 读卡机控制芯片

##### 多媒体控制应用

- LCD 显示器控制 / 电视控制芯片
- 视频接口转换控制芯片

Realtek provides IC solutions for communications networks, computer peripherals, and multimedia devices. For 33 years, our wired & wireless technology have facilitated connections and communications between people and their device; facilitating progress toward enriched, high-quality living.

Realtek offers a wide range of products in three main areas, including eleven flagship products. Its products are used throughout daily life, and its flagship models offer outstanding performance;

#### Applications:

- Connected Home
- Smart City
- Infrastructure
- Connected Car

#### Flagship Products:

##### Communications Network ICs

- Automotive Ethernet Switch/ PHY
- Switch/ Gateway Controllers
- xDSL/ xPON Controllers
- Wi-Fi/ BT/ IoT Controllers

##### Connected Media ICs

- Ethernet NIC/ PHY
- STB/ OTT Controllers
- Computer Peripheral ICs
- CE/ PC Audio Codec
- IP/ PC Camera Controllers
- Hub/ Type-C/ Card Reader Controllers

##### Multimedia ICs

- LCD Monitor Controllers
- LCD TV Controllers
- Display Translators



## 赛趋科软件 (上海) 有限公司

### Centric Software (Shanghai) Co.,Ltd

W3-3C113

地址: 上海市浦东新区陆家嘴东路 161 号 32 楼

电话 /Tel: 400-061-2518

网址 /Web: [www.centricsoftwarechina.com](http://www.centricsoftwarechina.com)

Centric 软件®总部位于硅谷, 是全球领先的产品生命周期管理 (PLM) 解决方案服务商, 专注于零售、时尚鞋服、食品饮料、化妆品、家居家具、户外用品和消费电子等企业打造从产品概念到销售的端到端的产品研发管理数字化转型平台。旗下旗舰级产品 - Centric 8 PLM 能够为快速变化的消费行业提供涵盖从概念到零售的商品研发管理解决方案, 以缩短产品上市周期, 促进团队协作并降低运营成本。

#### 主要展品 /Products

Centric PLM 旗舰级产品生命周期管理平台专门为快速发展的消费品行业提供企业级的商品规划、产品开发、采购、质量和产品组合优化创新。

Centric Digital Boards 可视化创新平台为协作和决策提供高度可视化的触屏体验。

Centric Planning 是一个创新的云端智能平台, 提供端到端的零售规划, 旨在在全渠道最大化零售业务价值。

## SAMSUNG

三星(中国)投资有限公司

SAMSUNG (CHINA) INVESTMENT CO., LIMITED

地址: 北京朝阳区望京东园四区2号楼中航产融大厦23层(100015)

电话 /Tel: 81006100

传真 /Fax: 81006100

网址 /Web: <https://www.samsung.com/cn>

三星集团是上市企业全球500强, 包括众多的国际下属企业, 旗下子公司有: 三星电子、三星物产、三星航空、三星人寿保险等, 业务涉及电子、金融、机械、化学等众多领域。三星电子是一个全球性的信息技术企业, 产品包括家用电器(如电视、显示器、冰箱和洗衣机), 和主要的移动通信产品(如智能手机和平板电脑)。此外, 三星还是重要电子部件(如DRA和非存储半导体)领域的供应商。三星致力于通过不断创新来改善生活方式。

### 主要展品 /Products

Neo QLED 8K, 三星随享系列智能投影仪, 三星画壁系列融入屏, Mini LED

SAMSUNG BESPOKE 缤色铂格系列

三星回音壁条形音响

Samsung Z Fold3, Samsung Z Flip3

W4-4F31 4H51



三友继电器

SANYOU RELAYS

三友联众集团股份有限公司

Sanyou Lianzhong Corporation Limited

地址: 广东省东莞市塘厦镇莆心湖中心二路27号(523719)

Add: No.27, Center 2 Road, Puxinhu, Tangxia Town, Dongguan, Guangdong

电话 /Tel: 0769-85911599

传真 /Fax: 0550-8036988

网址 /Web: [www.sanyorelay.com](http://www.sanyorelay.com)

三友联众集团股份有限公司是一家专业的集继电器、互感器、共模电感、磁性材料研发、制造、销售为一体的高新技术企业, 2021年1月在深圳证券交易所创业板上市。公司产品涵盖通用功率继电器、磁保持继电器、汽车继电器、高压直流继电器、光伏继电器、互感器、共模电感和磁性材料八大类, 公司连续多年入选中国电子元器件百强企业。

Sanyou Corporation Limited is a professional high-tech enterprise integrating R&D, manufacturing and sales of relays, transformers, common mode choke, and magnetic materials and is one of the top 100 Chinese electronic components enterprises. And it has been listed on the Shenzhen Stock Exchange Growth Enterprise Market in January 2021. After years of development, the company has formed a full-process service system integrating technology research and development, mold development and manufacturing, equipment development and manufacturing, production and manufacturing, and after-sales service.

### 主要展品 /Products

继电器、互感器、共模电感、磁性材料

relays, transformers, common mode choke, magnetic materials

W3-3C65 3C66 3C67



桑能实业(上海)有限公司

SHANGHAI SUNNER INDUSTRY CO., LTD

地址: 上海市同普路898号707室(200333)

Add: Suite 706-707, Huitu Mansion, 898 Tong Pu RD, Shanghai, 200333, China

电话 /Tel: 021-51693839

传真 /Fax: 021-52100184

网址 /Web: [www.sunnerelectric.com](http://www.sunnerelectric.com)

我司专业生产烤箱配件, 深耕白色家电配件领域20年, 积累了丰富的行业经验, 赢得了国内外客户的信赖。生产配件包括: 烤箱灯、接线盒、齿轮盒、烤肉叉。

Our company specializes in the production of oven accessories, deeply cultivated in the field of white appliances accessories for 20 years, accumulated rich experience in the industry, won the trust of customers at home and abroad. Production accessories include: Oven lamp/ Terminal box / Gear box / Turnspit

### 主要展品 /Products

烤箱灯、接线盒、齿轮盒、烤肉叉

Oven lamp/ Terminal box / Gear box / Turnspit

N4-4B40

## HESITE

山东亨斯特智能科技有限公司

Shandong Hesite Intelligent Technology Co., Ltd

地址: 山东潍坊(262400)

电话 /Tel: 0536-6655555

山东亨斯特智能科技有限公司创立于1999年, 专业的厨卫电器品牌和厨卫系统解决方案供应商。公司自成立以来, 始终坚守匠人精神。专业生产销售集成灶、洗碗机、集成水槽、电烤箱、电蒸箱、吸油烟机、燃气灶、消毒柜。

亨斯特厨房电器掌握核心科技, 凭借先进的制造设备、领先的智能制造工艺、卓越的产品品质, 不断为亿万家庭创造更高质量的厨房生活。

Shandong Hesite Intelligent Technology Co., Ltd., founded in 1999, is a professional brand of kitchen and bathroom appliances and a supplier of kitchen and bathroom system solutions. Since its establishment, the company has always adhered to the craftsman spirit. Specializing in the production and sales of integrated stoves, dishwashers, integrated sinks, electric ovens, electric steamers, range hoods, gas stoves and disinfection cabinets.

Hesite kitchen appliances master the core technology, and constantly create a higher quality kitchen life for hundreds of millions of families with advanced manufacturing equipment, leading intelligent manufacturing technology and excellent product quality.

### 主要展品 /Products

集成灶、洗碗机、集成水槽、电烤箱、电蒸箱、吸油烟机、燃气灶、消毒柜。

integrated stoves, dishwashers, integrated sinks, electric ovens, electric steamers, range hoods, gas stoves and disinfection cabinets

N2-2B24 2B25



### 山东圣阳锂电新能源有限公司

地址: 山东省泰安高新区一天门大街 1999 号  
电话 /Tel: 05385088055

W3-3C100

山东圣阳锂电新能源有限公司为山东国惠下属的上市公司圣阳股份(股票代码 002580)控股的国有公司, 创建于 2022 年, 专业从事于圆柱锂电的研发、生产和销售。圣阳股份承担着山东国惠新能源产业发展的使命, 面向海内外市场, 向客户提供电池产品、储能系统和一体化智能电源解决方案, 是国际知名、国内领先的绿色能源供应商。

#### 主要展品 /Products

18650: 20P/22P/20H/25P/25H/30H

21700: 40P/40H/50E



### 山东小鸭控股集团有限公司

#### SHANDONG XIAOYA HOLDING GROUP CO., LTD

地址: 山东省济南市工业南路 51 号  
Add: NO.51 Gongye Nan Road, Jinan, Shandong, 250101 China  
电话 /Tel: 400-658-6222  
网址 /Web: <http://www.xiaoyagroup.com.cn/>

W3-3F31

小鸭控股集团创始于 1979 年, 是全国六大洗衣机生产基地之一, 1984 年生产研发出亚洲第一台滚筒洗衣机“小鸭圣吉奥”, 荣获国内第一批“中国驰名商标”“中国名牌”。经过 40 余年改革发展, 确立了“电器制造”和“汽车配套”两大主业, 重点发展壮大以洗涤电器、冷链电器为主的电器制造业和以汽车装备、汽车零部件为主的汽车配套产业。

Founded in 1979, Xiaoya Holding Group was one of the six major washing machine production bases in China. Initially imported from S.GIORGIO, Italy in 1984, Xiaoya launched the 1st front-loading washing machine in Asia at the same year, which became one of the first batch of “China Well-known brand” and “China Top Brand”. Over more than 40-year’s development, electrical appliance manufacturing and auto-component supplying have been becoming Xiaoya’s two major businesses. Electrical appliance consists of domestic and industrial laundry products and cold-chain products. Auto-component and its manufacturing facilities constitutes Xiaoya’s auto-component business.

#### 主要展品 /Products

小鸭高端滚筒洗衣机内置尖端传感器、WIFI 远程控制技术, 实现智能投放、智慧洗衣  
小鸭 MINI 系列产品涵盖冰、洗、护等电器品类, 经多年研发创新, 在洗衣机细分领域已建立行业引领  
厨卫产品涵盖烟机、灶具、热水器等, 针对中式烹饪火力需求, 专注智能、高效、节能  
康养产品氢气机, 基于氢气抗氧化原理, 产氢纯度高达 99.9%, 多种模式全身呵护  
小鸭智能马桶一体机为华为鸿蒙生态链产品, 带来 5G 专享的智能洗护新体验



### 山东一腾小家电有限公司 Shandong Yiteng Small Appliance Co.,Ltd

地址: 山东省宁津县经济开发区正阳路以西(和胜电器)院内一腾小家电有限公司(253400)  
Add: West of Zhengyang Road, Economic Development Zone, Ningjin county, Dezhou city, Shandong Province, China

电话 /Tel: 0534-5532929

传真 /Fax: 0534-5532929

网址 /Web: [yitengxiaojidian.cn](http://yitengxiaojidian.cn)

N3-3A39

山东一腾小家电有限公司, 占地 100 亩, 主要从事小家电、厨房用品、美容产品、汽车等塑胶部件的模具加工及注塑、吹塑规模加工制造和整体配套能力。公司拥有先进的自动化生产设备, 主要设备有: 注塑机、吹塑机、整机组装线及相关实验室、检测仪器。现年产 OEM 豆浆机、破壁机 300 万台, 年销售 2 个亿。现已拥有自主研发品牌“大潼小宇”空气炸锅。我们秉承人本、诚信、求实、创新的企业理念, 真诚期待与您的合作。

Shandong Yiteng Small Appliance Co.,Ltd, covering area of 4100 square meters, mainly engaged in producing home-use appliance, kitchen products, beauty products, automobiles accessories associated with plastic, molding injection, mould development and ability to provide whole matched items, etc. Our plant owns advanced automatic production facilities, including injection mold machine, plastic blowing machine, all lab equipped with relative facilities for OEM and ODM and testing machines. That’s about 3 million sets of OEM soy milk machine being produced every year to create value of 200 million RMB. For now, we have successfully developed brand new air fryer called DTXY. We’re honest grateful to be looking forward cooperation with you.

#### 主要展品 /Products

空气炸锅、米桶、饺子盒、垃圾桶、硅胶件、线束

AIR FRYER, CEREAL BUCKET, DUMPLINGS STORAGE, TRASH BIN, SILICA GEL PARTS, CABLE



### 山东正能电池有限公司 Shandong Zhengneng Battery Co. LTD

地址: 山东阳谷县闫楼工业区(252300)  
Add: Yanlou Industrial Zone, Yanggu County, Shandong Province

电话 /Tel: 0635-2159656

传真 /Fax: 0635-2159656

网址 /Web: [www.znbatteries.com](http://www.znbatteries.com)

W3-3A45

山东正能电池有限公司, 位于山东省聊城市, 是一家专注于生产锂电池的公司, 其中以 18650 型电池为主。可根据电池尺寸、容量进行定制, 以满足客户对产品的多方面需求。公司总投资 600 万元, 占地 4000 平方米, 年可生产锂电池组 300 万套。

公司拥有完整、科学的质量管理体系, 人性化的管理和高效生产线, 生产高循环次数的电池。从您需求出发, 制造优稳的电池, 令您百分百满意。

Shandong Zhengneng Battery Co., LTD., located in Liaocheng city, Shandong Province, is

a company focusing on the production of lithium batteries, mainly 18650 batteries. It can be customized according to battery size and capacity to meet customers' various requirements for products. With a total investment of 6 million yuan and an area of 4,000 square meters, the company can produce 3 million sets of lithium battery packs annually.

The company has a complete and scientific quality management system, humanized management and efficient production line, can produce high cycle times capacity battery. Based on your needs, we can produce high quality and stable batteries. We sincerely hope that our batteries can bring more power to your products, so that you can be 100% satisfied.

#### 主要展品 /Products

山东正能电池有限公司是一家专注于生产锂电池的公司,其中以 18650 型电池为主。可根据电池尺寸、容量进行定制,以满足客户对产品的多方面需求。

Shandong Zhengneng Battery Co., Ltd. is a company focusing on the production of lithium batteries, mainly 18650 batteries. It can be customized according to battery size and capacity to meet customers' various requirements for products.



#### 上海宝松包装材料有限公司 Shanghai Pouson Packing Material Co.,Ltd.

W3-3H98

地址:上海市青浦区绿湖路 360 弄 8 号 401 室  
电话 /Tel: 13917596998  
网址 /Web: <http://www.pouson.com>

上海宝松包装材料有限公司销售各种系列烫印箔,广泛应用于各色各样产品。产品适用范围包括印刷包装、烟盒、酒盒、贺卡、纹身贴纸、输液袋、酒标、手提袋、家庭电器 Logo、化妆品软管、纺织品、汽车仪表指针及部件标饰,以及无数的日常用品之上等。

#### 主要展品 /Products

公司主要经营产品:烫印箔,拉丝箔,镭射箔,颜料箔等。  
Hot Stamping Foil



#### 上海奔泰水处理设备有限公司 Shanghai Bentai Water Treatment Equipment Co., Ltd.

N3-3F01

地址:浦东新区川大路 518 号 (201200)  
Add: No.518 & 508, Chuanda Rd, Pudong, Shanghai, China  
电话 /Tel: 021-58599999  
传真 /Fax: 021-58599977  
网址 /Web: <http://www.canaturewater.com>

上海奔泰水处理设备有限公司隶属于开能健康科技集团股份有限公司。一直深耕人居环境健康环保产业,是集研发、智造、服务于一体,具有国际影响力的专业净水产品制造企业,拥有 200 余项国际认证及专利,产品远销 100 多个国家和地区,让全球数百万家庭享受健康好水。

Founded in 2001 by Mr. Qu Jianguo, a well-known entrepreneur in China. Located close to the Shanghai Pudong International Airport and Disneyland.

A large professional "one-stop manufacturer" of water treatment systems and components in China. We have over 1200 full-time employees in Canature headquarter. Our manufacturing plant covers an area of 85,000+ square meters. Canature is the first public company in water treatment field in China.

#### 主要展品 /Products

专业研发和制造符合中国水质污染特点的水处理产品——全屋净水设备、全屋软水设备、商用净化饮水设备、反渗透 RO 机等系列产品及其核心部件,并为用户提供相配套的增值服务。

We specialize in R & D and manufacturing water treatment products in line with China's water pollution characteristics - a series of products and their core components such as whole house water purification equipment, whole house soft water equipment, com



#### 上海昌谊贸易有限公司

E3-3A32

地址:上海市中春路 8633 弄 15 号 618 室  
电话 /Tel: 13646502696

上海昌谊贸易有限公司是一家出口公司,主要以小家电为主。

#### 主要展品 /Products

理发器,电吹风,羽毛球刀



#### 上海宸宫国际贸易有限公司 Dream innovative future corporation

W4-4A12

地址:上海市松江区荣乐东路 2369 弄 1 号 314 室 (201600)  
Add: Room314, NO.1 Lane2369, Rongle East Rd. Songjiang District Shanghai, China  
电话 /Tel: 17701621248  
传真 /Fax: 021-57749938  
网址 /Web: <http://www.creative-technology-sh.com/index.html>

上海宸宫国际贸易有限公司成立于 2016 年 05 月 24 日,注册地位于上海市松江区荣乐东路 2369 弄 1 号 314 室,法定代表人为辰己良昭。为日本株式会社 Creative Technology 的子公司,工厂为上海辰田半导体科技有限公司。经营范围包括电子产品、电子元器件、机电设备、家用电器、照明电器、金属制品、铝合金制品、陶瓷制品、橡胶制品、五金交电、日用百货的批发、进出口、佣金代理(拍卖除外)及相关配套服务

#### 主要展品 /Products

香薰空气净化多功能机  
电子布告栏  
香薰机  
鞋子除菌仪



上海承岳商贸有限公司  
Shanghai Chengyue Trading Co., Ltd.

## 上海承岳商贸有限公司

## Shanghai Chengyue Trading Co., Ltd

E1-1B32

地址: 上海市嘉定区安亭镇和静路 986 号世康大厦 1701

电话 /Tel: 18756560141

上海承岳商贸有限公司旗下自有家电品牌, 主营电热毯, 取暖垫, 取暖器, 除湿机等生活小家电。以追求生活品质的消费者为目标客户, 为他们提供更高级、更时尚的生活体验。不断精益求精, 用优质的服务提升每一位消费者的生活品质。力求在繁杂的生活中追求发展, 将各类时尚元素加入到产品中, 为消费者提供更高级、更时尚的家居产品。我们秉承着“热情服务, 产品创新, 品质保障”的原则, 致力于打造成全国高端居家小家电的尖端品牌。

## 主要展品 /Products

除湿机 加湿器 电热毯 循环风扇 烤箱 电暖气 养生壶

kitchen mummy  
厨创妈咪

## 上海厨创妈咪实业有限公司

N3-3A51

地址: 上海市闵行区福斯科科技园 2 栋 328

电话 /Tel: 4000010837

上海厨创妈咪实业有限公司代理品牌乐扣乐扣, 和自营品牌厨创妈咪, 专业从事厨房小家电的销售和推广。

## 主要展品 /Products

破壁机、空气炸锅、电火锅、研磨机、电蒸锅、电炒锅、养生杯、养生壶、电饭煲等



让未来更好

## 上海迪捷通数字科技有限公司

W4-4A57

## Shanghai Digiot Technology Co., Ltd

地址: 上海市杨浦区平凉路 2241 号 17 号楼 5 楼 (200000)

Add: 5th Floor, Building 17, No. 2241 Pingliang Road, Yangpu District, Shanghai

电话 /Tel: 400-001-7771

传真 /Fax: 021-55082056

网址 /Web: www.digiot.cn

迪捷通数字科技致力于提供安全、高效、低碳的智慧社区数字化解决方案, 融合 5G、物联网、人工智能、大数据、云计算等技术, 横向打造社区内基于人、机、环的智能硬件产品, 纵向贯穿智能家居、数字办公、智慧酒店的应用场景解决方案, 为生态合作伙伴提供咨询、设计、生产、集成的一站式服务。

Digiot is committed to providing safe, efficient, and low-carbon digital solutions for smart communities, integrating technologies such as 5G, the Internet of Things, artificial intelligence, big data, and cloud computing to horizontally create intelligent hardware products based on people, machines, and the environment within the community, and vertically penetrate application

scenario solutions for smart homes, digital offices, and smart hotels, providing consultation, design, production Integrated one-stop service.

## 主要展品 /Products

高端品质, 致敬美好生活。迪捷通作为太阳雨智能家居全国总代理, 致力于提供全屋智能解决方案, 为您提供放心、省心、贴心的服务。

High quality, paying tribute to a good life. As the national general agent of Sun Rain Smart Home, Dijie Tong is committed to providing intelligent solutions for the entire house, providing you with reassuring, worry free, and thoughtful services.



## 上海迪勤智能科技有限公司

W3-3D110 3D111

## DST TECHNOLOGY

地址: 上海市静安区江场西路 300 号 B 幢 4 层 (100021)

Add: Floor4, Building B, Lane 300, Jiangchang West Road, Jing'An District Shanghai

电话 /Tel: 021-66109780

传真 /Fax: 021-66109780

网址 /Web: http://www.dstair.com

迪勤科技 DST Technology 成立于 2012 年, 是一家集传感器、智能硬件及环保仪表的设计、开发、集成制造、销售、服务为一体的高新技术企业, 呼吸原力 (Breathforce) 为旗下的独立品牌, 由于人们对更高品质的呼吸环境的渴望, 已逐步形成了以专业监测 (air sns) 为基础, 多种治理方式为手段, 联动控制为保护的多技术、多产品结合的智慧空气解决方案。

"Breathforce (Breathforce) is an independent brand of Diqin Technology (DST), formerly known as air sns.

Due to people's desire for a higher-quality breathing environment, a smart air solution with multiple technologies and multiple products based on professional monitoring (air sns), multiple governance methods as means, and linkage control as protection has been gradually formed. Therefore, Breathforce has been promoted with a broader product concept, moving in the direction of AIOT and customized air environment."

## 主要展品 /Products

迪勤科技成立于 2012 年, 坐落于国家自主创新示范区、上海市大数据产业基地——市北高新技术服务业园区, 致力于成为全球领先的基于智慧物联网的生态环境数据服务提供商, 以传感技术为核心, 采用物联网、云计算、大数据、AI 等新 ICT 技术, 构建全方位、多层次的环境质量监控网络, 从大气环境到室内人居到车内空间, 从监测到净化到治理, 实现环境质量可视、可管、可控、可互动, 助力“智慧与绿色共融, 健康与商业同行”

"Breathforce (Breathforce) is an independent brand of Diqin Technology (DST), formerly known as air sns.

Due to people's desire for a higher-quality breathing environment, a smart air solution with multiple technologies and multiple products based on professional monitoring (air sns), multiple governance methods as means, and linkage control as protection has been gradually formed. Therefore, Breathforce has been promoted with a broader product concept, moving in the direction of AIOT and customized air environment."

**FLYCO 飞科****上海飞科电器股份有限公司**

地址: 上海市松江区广富林东路 555 号

电话 /Tel: 021-52858888

**E3-3F11**

飞科公司创立于 1999 年, 是一家以“研发创新”和“品牌运营”为核心竞争力, 集剃须刀及个护电器、生活电器、美姿电器、口腔护理电器、厨房电器、健康电器等智能时尚电器产品研发、制造、销售于一体的全球化科技企业。

**主要展品 /Products**

剃须刀、吹风机、电动牙刷、毛球修剪器、卷发棒、理发器、鼻毛修剪器、女士剃毛器、加湿器、电熨斗、蒸汽挂烫机、吸尘器等

**上海冠显光电****上海冠显光电科技有限公司****Shanghai Top Display Optoelectronics Technology Co., Ltd**

地址: 上海市闵行区新骏环路 88 号 13A 栋 4 楼 (200114)

电话 /Tel: 021-64297089

传真 /Fax: 021-64297089

网址 /Web: <http://www.shtdo.com/>**N1-1B17**

上海冠显光电科技有限公司集研发、制造、销售为一体, 致力于成为 LCD/OLED 新型显示、近眼显示、智能显示与 IOT 方案的领导者。聚焦智能家居、智能家电、物联网、工业、医疗、军工、空气净化、仪器仪表、机器人、3D 打印等行业应用市场。在深圳全资拥有专业净化制造工厂。自主研发了多项技术专利, 2016 年荣获上海市高新技术企业, 目前已申请超过 17 项技术专利, 其中授权 15 项。

**主要展品 /Products**

公司主要经营的产品有: TFT-LCD 显示模组与触摸屏、TGUS® 智能串口显示模组、HDMI 显示方案、硅基 OLED 显示、OLED 显示方案、Theaview® 户外阳光下可视显示模组、物联网显示方案。

**上海哈克过滤科技股份有限公司****Hawk Filtration Technology(Shanghai) Co., Ltd**

地址: 上海市青浦工业园区崧华路 1558 号

电话 /Tel: 86-21-39815477

**W2-2G51**

上海哈克过滤科技股份有限公司是一家生产过滤器的专业厂家, 主要产品规格约 1000 余种, 主要配套空气净化器、新风系统、汽车空调、个人防护、水过滤及工业过滤。公司致力于服务于精密电子、芯片加工封测、半导体、家电、生物制药、医疗器械, 实验室、印刷、涂装、食品、汽车等行业。客户分布于北美, 欧洲及国内各知名品牌。

**主要展品 /Products**

上海哈克过滤科技股份有限公司是一家生产过滤器的专业厂家, 主要产品规格约 1000 余种, 主要配

套空气净化器、新风系统、汽车空调、个人防护、水过滤及工业过滤。公司致力于服务于精密电子、芯片加工封测、半导体、家电、生物制药、医疗器械, 实验室、印刷、涂装、食品、汽车等行业。客户分布于北美, 欧洲及国内各知名品牌。

**HIGHLY 海立****上海海立电器有限公司****Shanghai Highly Electrical Appliances Co., Ltd**

地址: 上海市浦东新区宁桥路 888 号 (201206)

电话 /Tel: 021-50554560

传真 /Fax: 021-58991948

**W2-2F01**

上海海立电器有限公司创建于 1993 年 1 月, 由上海电气旗下的上海海立 (集团) 股份有限公司、江森自控日立空调 (JCH) 合资组建而成, 是全球领先的空调压缩机研发、制造、销售企业, 产能规模 3000 万台 / 年, 全球市场份额 15%, 位居全球第三。

公司坚持专业化发展之路, 实施国际化产业布局, 上海作为总部, 在上海、南昌、绵阳、印度建立了 4 个世界级绿色工厂, 并在中国、欧洲、印度、日本、美国等地设立 7 个技术服务中心。

**主要展品 /Products**

家用空调压缩机、轻商用空调压缩机、非家用空调压缩机

Household AC、Light Commercial AC、Non-household AC

**上海鹤立心选网络科技有限公司****Shanghai helixinxuan Network Technology Co., Ltd**

地址: 上海普陀区金沙江路 1340 弄 8 号楼新曹杨中南大厦 10 楼 (200062)

Add: xincayang Zhongnan building, building 8, Lane 1340, Jinshajiang Road,

Putuo District, Shanghai

电话 /Tel: 021-61362536

传真 /Fax: 021-61361477

网址 /Web: <https://helixinxuan.com/>**E2-2C31**

鹤立心选网络科技有限公司是一家专注于为企业提供“云供应链 + 技术研发 + 运营策划”三大核心服务能力的礼业服务商。

通过自主研发礼业渠道 SaaS 系统, 帮助企业快速搭建数字化、场景化采购平台, 助力礼业伙伴实现数字化销售能力, 为企业提供一站式解决方案。

Heli Xinxuan Network Technology Co., Ltd. is a gift service provider focusing on providing enterprises with three core service capabilities of "cloud supply chain + technology R & D + operation planning".

Through the independent research and development of SaaS system for gift industry channels, it helps enterprises quickly build a digital and scene procurement platform, helps gift industry partners realize digital sales capacity, and provides one-stop solutions for enterprises.

**主要展品 /Products**

洗地机、厨房锅具、生活小家电、家纺

Floor washer, Kitchen utensils, Household appliances, Home textiles



## Hongxin 红心

### 上海红心器具有限公司 Shanghai Hongxin Appliances Co., Ltd

E1-1H41

地址: 中国(上海)自由贸易试验区杨高中路 2108 号 (200135)  
Add: No. 2108, Yanggaozhong Rd, Pudongxin District, Shanghai City, China  
电话 /Tel: 021-50280878  
传真 /Fax: 021-58219673  
网址 /Web: www.hongxin-sh.com

1943 年起源于中国上海红心电器, 70 余年传承民族经典, 专注于家用电器领域, 以科技成就完美品质, 致力于高品质生活小家电产品的创新设计, 不断满足消费者对高品质与高品位生活的追求, 在未来生活电器潮流中打造新时代的国民品牌, 让千家万户尽情享受现代化生活的愉悦与乐趣。

#### 主要展品 /Products

电熨斗、挂烫机、空气炸锅、煎烤器

## HGTECH

### 上海华工艾马尔新材料有限公司 Shanghai Huagong Amar New Material Co., Ltd

W5-5A05

地址: 上海市嘉定工业区兴贤路 599 号  
Add: No. 599 Xingxian Road, Jiading Industrial Zone, Shanghai, China  
电话 /Tel: 021-39538987  
网址 /Web: www.hgimr.com

华工艾马尔是国内 IMR 技术的引领者、模内转印专家、模内装饰整体解决方案提供商, 高科技上市公司华工科技(股票代码: 000988)的下属单位。公司总部位于上海市嘉定工业园区内, 拥有各类高精尖端技术人员, 配备千级及万级无尘净化车间和世界一流的生产检验设备。致力于产品研发和新工艺设计, 公司生产的模内转印材料产品广泛应用于家电、3C、汽车等外观装饰领域, 凭借前瞻性的研发与全产业链的优势为您的产品保驾护航。

HG IMR is a leader in domestic IMR technology, in-mold transfer expert, an integrated solution provider for in-mold decoration, and a subordinate unit of HGTECH (stock code: 000988), a high-tech listed company. HG IMR is headquartered in Jiading Industrial Park, Shanghai. It has all kinds of sophisticated and cutting-edge technical personnel, equipped with Class 1000 and Class 10000 dust-free purification workshops and world-class production and inspection equipment. Committed to product research and development and new process design, the in-mold transfer material products produced by the company are widely used in household appliances, 3C, automobiles and other exterior decoration fields. With the advantages of forward-looking research and development and the whole industrial chain, your products will be protected.

#### 主要展品 /Products

IMD 家电表面装饰膜片及装饰件、3C 产品表面装饰膜片及装饰件、汽车内饰表面装饰膜片等  
IMD 表面装饰 CMF 设计到量产服务

IMD home appliance surface decorative film and decorative parts, 3C product surface decorative film and decorative parts, automobile interior surface decorative film, etc  
IMD surface decoration CMF design to mass production service



### 上海华舍集良智能科技有限公司 Shanghai Hua She Ji Liang Intelligent Science and Technology Co., Ltd

W4-4A31

地址: 上海市松江区广富林路 4855 弄星月大业领地 8 号楼 3F  
电话 /Tel: 021-37663226

华舍集良成立于 2019 年 1 月, 位于上海市松江国家级经济技术开发区的企业总部园, 是一家从事智能电子产品和相关自主技术研发、市场运营的科技创新型公司。旗下产品和服务覆盖家居、户外、办公、文教、美甲等多个市场领域和应用场景。通过自主开发、合作普惠实用型创新技术赋能消费电子行业产业集群, 促进企业技术创新、智能化转型、产品品质提升和产学研合作, 并为消费者提供性能卓越、便捷安全、节约高效的科技创新型智能产品。

#### 主要展品 /Products

英汉驰运用自主技术形成的颠覆性的、模式创新的、跨品类关联兼容的、多维度优势叠加的、可持续生成和升级迭代的、新颖的生态型产品。

英汉驰多品类产品由集约的电源支持方式, 实现产品的小型轻量化; 去除产品易损件延长产品生命周期和使用安全; 提升全品关键性能的用户体验; 进一步节约用户成本; 以非同质化的产品迭代市场; 以“不减电器、只减电池”创新模式同频实现用户、社会和环境的综合成本优化和能效提升。



Worldwide Logistics Group  
环世物流集团

### 上海环世物流(集团)有限公司 Worldwide logistics Group

W5-5D81

地址: 海市杨浦区宁国路 228 号郡江国际大厦 B 座 1401 (200090)  
电话 /Tel: 021-61322333  
网址 /Web: www.worldwide-logistics.cn

环世物流集团创立于 2001 年, 全球员工超过 1800 名, 是国家 5A 级物流企业, 拥有国际货代物流行业最高信用等级 3A 级资质。根据中国物流与采购联合会发布的 2022 中国物流企业榜单, 环世物流排名第 23 位; 中国企联 2022 中国服务业企业 500 强排名第 383 名; 2022 上海市企业联合会上海企业百强榜单排名第 86 位, 上海民营企业百强第 38 名。

#### 主要展品 /Products

环世物流集团以自有散杂货船队、罐式集装箱设备、车队、货站和仓库为载体, 拥有国际海运集装箱整箱及拼箱、件杂货、大宗散货、集运、国际空运(干线包板、地面操作)、国际陆运(铁路、公路、水路多式联运)、化工物流(罐式集装箱、危险品车队)、工程项目物流、跨境电商物流、仓储码头服务等产品线, 可为全球客户提供端到端的国际物流履约服务。

## 声网

上海极音网络科技有限公司  
Shengwang

W3-3H70

地址: 上海市杨浦区淞沪路 333 号创智天地 3 期 7 楼 (200082)

电话 /Tel: 021-31169323

传真 /Fax: 021-31169323

网址 /Web: www.agora.io

声网 (NASDAQ:API) 成立于 2014 年, 是全球实时互动云服务开创者和引领者。开发者只需简单调用 Agora API, 即可在应用内构建多种实时音视频互动场景。声网 Agora API 已经赋能社交直播、教育、游戏电竞、IoT、AR/VR、金融、保险、医疗、企业协作等 20 多个行业赛道, 共计 200 多种场景。声网的实时互动技术服务覆盖全球 200 多个国家和地区。

Founded in 2014, Agora is the leading and pioneer of global Real-Time Interactive RTE-PaaS Cloud. Powered 50Bn+ minutes per month (in 2021 Q1) of real-time video and voice engagement through 372,000 Apps registered worldwide in September 2021.

Developers can create multiple real-time video and voice engagement scenarios within 30 mins through simple APIs. 200+ scenarios and 20+ industries are covered, including social live streaming, online education, games, VR / AR / IoT, insurance, telehealth, and team collaboration. Agora's real-time interactive technologies and services cover all regions globally, and provide technical and operational support locally. Agora APIs are widely adopted by giants, unicorns and startups such as Xiaomi, Momo, Bilibili, New Oriental Education & Technology Group, TAL, The Meet Group, Bunch to build in-app real time communications.

## 主要展品 /Products

Agora Inside™ IoT 云平台, 基于声网 Agora 实时音视频 PaaS 能力, 提供灵活、易用、完整的 IoT 场景化解决方案。Agora Inside™ IoT 云平台为开发者提供端到端、一站式的低代码开发 API, 具备呼叫连接、实时监控、语音双讲、远程控制等核心场景功能, 能够快速赋能实现硬件的场景化实时互动体验。

上海嘉矿科技有限公司  
XVGATE

W4-4B10

地址: 上海市徐汇区桂平路 391 号 3 号楼 B 座 1606 室

电话 /Tel: 021-64170810

视门智能 (XVGATE) 于 2021 年在中国创立。目前已成立北京、上海两支技术和运营团队。公司研发团队来自北京邮电大学、复旦大学、同济大学、微软、谷歌、苹果等全球顶级科研机构 and 科技公司, 具有人工智能机器视觉, 智能语音, 智能硬件, 虚拟人开发, 新媒体艺术的优势。自主研发的新型无穿戴 AI 视频动捕技术, 是人工智能和内容创作的深度结合。2023 年面市的首款潮玩摄像头将成为普通消费者走入元宇宙的桥梁。

## 主要展品 /Products

V 动视界潮玩摄像头, 集运动健身, 宠物监控, 娱乐互动, 体感游戏等多功能于一身的产品

上海捷宝金属集团有限公司  
Shanghai Jiebao Metal Group Co., Ltd

W5-5B36 5B37

地址: 上海市松江区余山镇余北路 2518 号 -1 号

电话 /Tel: 021-69922204

传真 /Fax: 021-69596870

网址 /Web: www.sh-jiebao.com

上海捷宝金属于 2006 年同德国葛利兹钢厂签约中国区代理商, 以及汽车保险杠用料中国总代理, 并于 2012 年先后成立了天津、厦门、宁波分公司。为客户提供模具钢的销售、加工、热处理一站式服务。连续多年被上海市模具行业协会评为“诚信企业”。

## 主要展品 /Products

1.2311、1.2312、1.2738、XPM、1.2343、1.2343VICTORY ESR、1.2344、1.2344 VICTORY ESR、1.2083、1.2083 VICTORY ESR、1.2085、1.2316、1.2316 VICTORY ESR、GEST80 ESR、CPM40 ESR、1.2711、1.2714、1.2379

1.2311、1.2312、1.2738、XPM、1.2343、1.2343VICTORY ESR、1.2344、1.2344 VICTORY ESR、1.2083、1.2083 VICTORY ESR、1.2085、1.2316、1.2316 VICTORY ESR、GEST80 ESR、CPM40 ESR、1.2711、1.2714、1.2379



VSGO

上海捷涌科技有限公司  
Shanghai Jieyong Technology Co.,Ltd.

N4-4A19

地址: 上海市嘉定区南翔镇南翔高科技园区惠平路 77 号 (201802)

电话 /Tel: 021-69899782

传真 /Fax: 021-39927793

网址 /Web: www.vsgo.com.cn

上海捷涌科技成立于 2004 年, 总部设在上海, 同年创立自主品牌“VSGO 微高”, 是一家希望通过好的产品“连接设计与人”的创新设计品牌。VSGO 微高从影像光学清洁入局, 以设计、功能、交互的三元视角, 研发并实践产出一系列以产品功能和用户体验为核心的创新设计产品, 深受好评和信赖, 并获得多项国际设计大奖, 包括德国红点奖, 德国 IF 设计奖以及金点设计奖。

Shanghai Jieyong Technology was founded in 2004, headquartered in Shanghai. At the same year, it established its own brand "VSGO", which is a committed to innovation design brand, hope to "connect design and people" via good products. VSGO foodhold in optical device cleaning business, through design, function and interaction of ternary perspective, developed a series of innovative design products with functions and user experience, since 2018, VSGO won a number of international design awards, including the red dot award, the IF design award and golden design award.

## 主要展品 /Products

AIRGO 暴风胶囊 V1, 是一款多功能吹吸一体吸尘器。

该产品具备小巧便携、强大动力、吹吸一体、前后照明、空气过滤等功能, 可以满足数码影像、车载出行、



户外露营（精致露营）、手冲咖啡等多个领域的清洁吹吸使用需求。

AIRGO Storm Capsule V1, which is a multifunctional vacuum cleaner.

Small and portable, powerful power, integrated blowing and suction function, front and rear lighting, air filtration and etc, AIRGO storm capsule V1 can meet needs of digital imaging, car travel, outdoor camping (glamping), hand-made coffee and other fields of clean blowing and suction.

## LocknLock

上海乐扣乐扣贸易有限公司

N3-3F21

SHANGHAI LOCK&LOCK TRADING CO.,LTD

地址: 上海市闵行区宜山路 2016 号合川大厦 3 楼 D/H 座 (200233)

Add: Block D/H, 3F, Hechuan Building, No. 2016, Yishan Road, Minhang District, Shanghai, China

电话 /Tel: 021-54222228

传真 /Fax: 021-54222667

网址 /Web: www.locknlock.com.cn

乐扣乐扣将公司的理念设定为“一家重视环境和人的公司”而且自从公司 1978 年成立伊始, 就将消费者的健康、安全和便利作为我们的首要任务。乐扣乐扣期望用优良的品质和国际化的竞争力成为全球知名的综合家用产品公司。

主要展品 /Products

空气炸锅、多功能锅、榨汁机、电饭煲、电热饭盒、电水壶、养生壶、料理机、咖啡机

RIWA 雷瓦

上海雷瓦电器有限公司

E3-3C11

SHANGHAI RIWA ELECTRICAL APPLIANCE CO.,LTD

地址: 上海市松江区沪松公路 1399 弄 68 号 9 层 01 室

电话 /Tel: 021-67763332

雷瓦电器成立于 2012 年, 是一家专注于中高端美容美发个护造型产品的创新公司, 专注产品研发和品牌运营, 创始人拥有超过 20 多年相关行业的出口贸易经验, 产品主要销往欧美等发达国家和地区。

公司产品涵盖盖直发器、电吹风、理发器等, 电动牙刷和美容健康仪器等领域, 目前公司已获得超过 70 项发明专利、外观专利、实用新型专利等; 多款产品获得具有国际影响力的德国红点奖, 中国红星奖及韩国好设计等工业设计大奖

主要展品 /Products

卷 / 直发器、吹风机、理发器、剃须刀

## Rinnai

林内

上海林内有限公司

N1-1C21

地址: 上海市奉贤区奉城镇团青公路 4500 号 (201411)

电话 /Tel: 021-67583500

传真 /Fax: 021-67583555

网址 /Web: www.rinnai.com.cn

1993 年 9 月, 上海林内有限公司由林内和上海燃气 (集团) 有限公司共同投资成立, 属上海市高新技术企业。公司秉承林内近百年的技术底蕴, 依托林内先进的设备、工艺和研发能力, 以生产燃气热水器、燃气灶、壁挂炉、吸油烟机, 以及全屋净水系统等产品为主, 并获得了 JIA 品质保证 A 级工场的评价。上海林内坚持以“创造更健康的生活方式”为企业发展的理念, 致力于为更多的用户提供健康、舒适、高品质的生活。

主要展品 /Products

生产燃气热水器、燃气灶、壁挂炉、吸油烟机, 以及全屋净水系统等产品为主



上海炉石信息科技有限公司

W4-4D80

Loostone

地址: 上海市松江区泗砖路 351 号交科科技园 2 号楼 6 楼 (201601)

电话 /Tel: 02180332810

传真 /Fax: 02180332810

网址 /Web: http://www.loostone.com/

上海炉石信息科技有限公司 (简称炉石科技) 总部位于上海, 成立于 2015 年, 是一家专注于音频智能产品设计、研发的高新技术企业。我们拥有产品设计、软硬件研发、生产、市场销售等团队。主营智能音频产品, 并且为电视、汽车、机顶盒提供 K 歌方案, 旗下拥有自主品牌“纯麦”。炉石一直致力于成为创新数字娱乐领域的智能及自动化专家, 创新数字娱乐, 为每个人创建更高级、更沉浸、更纯粹的音樂体验。

主要展品 /Products

纯麦音浪 N 次方串联音箱 S3

纯麦多场景 K 歌无线麦克风 Q1 PRO

纯麦无线 K 歌麦克风 U7PRO

纯麦智能点唱机 K2

纯麦家庭 KTV 混音器 X2

纯麦无线 K 歌音箱 S2

MLILY 梦百合

**上海梦百合家居科技有限公司**  
**SHANGHAI MLILY BEDDINGS CO., LTD.****W3-3F91**

地址: 上海市徐汇区蒲汇塘路 118 号汉光国际大厦二层 (200030)

Add: Floor 2, ShangHai HanGuang International Building, NO.118, PuHui Tang Road,

Xuhui District, Shanghai

电话 /Tel: 021-60737808

传真 /Fax: 021-60737800

网址 /Web: www.mlily.com

Mlily 梦百合致力于提升人类的深度睡眠, 是 0 压床垫开创者, 曼联全球官方合作伙伴, 为中国国家围棋队提供舒压产品。梦百合专注于非温感 0 压绵的研究与测试, 目前已拥有中国、加拿大、美国、丹麦等多国专利。

As the pioneer of the pressure-relieving mattress, Mlily is committed to improving the deep sleep of people. We are the official partner of Manchester United and the China National Go Team. Mlily has focused on the research and test of AeroFusion TM memory foam and has obtained patents in China, Canada, the United States, Denmark, and other countries.

**主要展品 /Products**

0 压床垫

zero- pressure mattress

**Pytes****上海派智能能源股份有限公司**  
**Shanghai PYTES Energy Co., LTD****E3-3B15**

地址: 上海派智能能源股份有限公司

电话 /Tel: 021-57475821

派智能能源是以锂电池制造为基础的高科技企业, 公司始创于 2004 年, 经过 18 年的行业积淀。公司已经发展布局了, 总部上海派智能能源, 山东派智能能源, 越南派智能能源以及山东派智新能源 4 个主要工厂。在境外成立了美国和荷兰子公司, 同时 2022 年在匈牙利新设立了锂电池生产线。公司目前全球员工约 1000 名, 年产能 1.82Gwh。

**主要展品 /Products**

锂离子电池组, 锂离子电池

**QiaoMai**  
**乔脉****上海乔脉电子科技有限公司****N3-3A26**

地址: 江苏省靖江市经济开发区阜康路 21 号 (214500)

电话 /Tel: 13365222860

网址 /Web: http://www.qmdianzi.com/

江苏乔脉仪器仪表制造有限公司是一家专业研发、生产中央空调、采暖自控、楼宇自动化、智能家

居的供应商, 公司拥有强大的科技研发团队, 良好的实验环境, 拥有国内先进年产 100 万台的生产流水线、高精度自动化贴片机流水线。具有行业 2 芯线控温控制器, 免去了接线繁琐苦恼, 避免了因为烧电机而带来的售后, 而在现场极大体现了安装方便的优势 (省工、省料、省时)。

**主要展品 /Products**

中央空调温控器 地暖温控器 新风控制器 小家电控制, 热泵控制

**QIAOH 侨亨****上海侨亨实业有限公司****W4-4A01**

地址: 上海市松江区车阳路 111 号 (201611)

电话 /Tel: 021-31166828

传真 /Fax: 021-31166818

网址 /Web: www.qiaoh.com

上海侨亨实业有限公司是一家集电子零部件研发、生产和销售于一体的国内知名企业, 创始于 1987 年, 专业从事燃气电磁阀、燃气比例阀、进水电磁阀、微动开关、风机、水流量传感器等产品的研发、生产和销售, 先后建立了 ISO9001 国际质量体系 and ISO14001 环境管理体系, 同时通过了 CCC、CQC、UL、VDE、ENEC、CE、D Mark、欧盟 ROHS 指令要求等国内和国际的相关知名认证。

**主要展品 /Products**

水流量传感器 燃气电磁阀 进水电磁阀 燃气比例阀 微动开关

**MXCHIP®**

上海庆科信息技术有限公司

**上海庆科信息技术有限公司****W3-3C76****Shanghai MXCHIP Information Technology Co., Ltd.**

地址: 上海市普陀区金沙江路 2145 弄 B 幢 (200333)

Add: 9th Floor, No.5, Lane 2145, Jinsha Jiang Road, Putuo District, Shanghai

电话 /Tel: 4006055820

传真 /Fax: 52655026

网址 /Web: www.mxchip.com

上海庆科信息技术有限公司 (简称“庆科信息”, “MXCHIP”) 是国内领先的物联网系统解决方案提供商, 为全球企业客户提供产品及场景智能化服务。公司业务涵盖无线模组、芯片、网关等硬件产品, 以及云平台、APP 等软件服务。

Shanghai MXCHIP Information Technology Co., Ltd. (MXCHIP), a global leading IoT solution provider, is honored as Little Giant high-tech enterprise in China. MXCHIP provides enterprise customers with hardware product and intelligent solution for various scenarios. The hardware products include self-developed wireless modules, chips and gateways, software development services include APP and Cloud SaaS development. Specialized in IoT industry for decades, and collaborating with mainstream cloud platforms such as Amazon AWS, Alibaba Cloud and Microsoft Azure.

MXCHIP has served more than 1,000 enterprise customers worldwide and connected more than 70 million devices. This gives MXCHIP rich product and project experience in smart home appliances, smart lighting, smart parks fields and other fields.

**主要展品 /Products**

1. 智联模组: Wi-Fi 模组、蓝牙模组、Wi-Fi+BLE combo 模组
2. 智能 APP 服务: 帮助厂商快速接入电商平台, 实现产品对平台 APP 的支持; 品牌智能化 APP 定制开发
3. 物联网云服务: 一站式物联网平台 Fogcloud; 企业物联私有云
4. 一站式物联网系统解决方案: 全屋智能方案、智能空气净化器方案、智能空调方案、智能净水器方案、智能照明方案、智能电工方案、智能宠物电器方案……

1. modules: Wi-Fi、BLE、Wi-Fi+BLE combo
2. Smart APP
3. Virtual private cloud
4. Fogcloud

5. Smart solution: smart home, smart lighting, smart electrical equipment, etc.

**上海日机装贸易有限公司****Shanghai Nikkiso Trading Corporation****E2-2H71**

地址: 上海市长宁区红宝石路 500 号东银中心 B 座 27 层 (201103)

电话 /Tel: 86-021-52393637

传真 /Fax: 86-021-52393639

网址 /Web: www.nikkiso-sh.com

日机装株式会社成立于 1953 年, 总部位于东京。集团涉足包括医疗器械、航空宇宙、工业及深紫外 LED 在内的四大支柱产业。其中血液透析机在日本国内市场占主导地位。日机装凭借“ORIGINAL TECHNOLOGIES”为用户提供具有创新性、技术力与高质量的产品与服务。

在我们的展区将展示一款由日机装开发的除菌除臭装置【安诺清】。

NIKKISO CO., LTD. was founded in 1953, headquartered in Tokyo.

The group is involved in four pillar industries including medical business, aerospace business, industrial business, and deep UV LED section. Among them, NIKKISO's hemodialysis machine occupies large market share in Japan. With the help of "Original Technologies", NIKKISO CO., LTD. Provides users with innovative, technical, and high-quality products and services.

In our exhibition area, we will display an antibacterial air purifier 'Annuoqing' developed by NIKKISO CO., LTD.

**主要展品 /Products**

日机装从 2006 年开始与 2014 年诺贝尔物理学奖获得者天野浩教授共同开发深紫外 LED, 2015 年成功实现了高功率的深紫外 LED 的量产化。2021 年 5 月, 搭载深紫外 LED 的空间除菌除臭装置【安诺清】正式在中国上市销售。该产品通过深紫外 LED 照射, 破坏细菌及病毒的 DNA 或 RNA 的螺旋构造, 从而根本上灭活细菌和病毒, 同时实现人机共存。尽管体型小巧, 但具备优异的除菌除臭性能。

Nikkiso and the 2014 Nobel Prize winner Professor Hiroshi Amano have jointly developed deep-ultraviolet LEDs from 2006. In 2015, Nikkiso successfully realized the mass production of the deep-ultraviolet LEDs which owns higher output power. In May 2021, Annuoqing equipped with the deep ultraviolet LEDs was officially launched in China. The deep ultraviolet LED irradiation in the product can destroy the helical structure of DNA or RNA of bacteria and viruses, and inactivate diseased bacteria and viruses. Despite the small size, it has a strong antibacterial and deodorant effect.

**ROTAI****荣泰****上海荣泰健康科技股份有限公司****E3-3F21****rongtai**

地址: 上海市青浦区朱枫公路 1226 号 (201714)

电话 /Tel: 021-31190888

传真 /Fax: 021-31190888

网址 /Web: <https://www.rotai.com/index.php>

上海荣泰健身科技发展有限公司是一家集研发、制造和营销优势为一体, 专注于健康产业的综合按摩器具制造商和品牌服务商。荣泰致力于提供舒适、安全、健康的按摩器具, 让人们在体验按摩产品的同时, 享受高科技带来的美好感受。作为地球公民的一份子, 荣泰坚持使用节能环保的材料和制造方式, 以成为业内环境贡献模范企业为目标, 为中国节能环保领域作出贡献。荣泰, 以科技的力量, 成就每个人的健康生活!

**主要展品 /Products**

RT8900 双子座按摩椅

**上海水护盾健康科技有限公司****E2-2F31****Philips Water Solutions**

地址: 上海市松江区玉秀路 136 号 2 幢 2 层 219 室 (201613)

Add: Room 219, floor 2, building 2, No. 136, Yuxiu Road, Songjiang District, Shanghai

电话 /Tel: 021-37000000

传真 /Fax: 86-021-37700066

网址 /Web: <http://www.philips.com.cn/>

上海水护盾健康科技有限公司, 作为飞利浦净饮水解决方案、热水解决方案、卫浴解决方案、水杯及个人按摩器唯一品牌官方授权运营主体, 秉承飞利浦“创新为你”的品牌理念, 不断通过多元化的产品组合设计, 为消费者提供全屋水健康解决方案及健康按摩的解决方案。包括:

- 净饮水健康解决方案
- 热水健康解决方案
- 智能卫浴健康解决方案
- 健康按摩的解决方案

Shanghai Water Shield Health Technology Co., LTD., as the only official authorized operating body of Philips clean drinking water solution, hot water solution, bathroom solution, water cup and personal massager, adhering to Philips' brand concept of "Innovation for you", continuously provides consumers with whole-house water health solutions and health massage solutions through diversified product portfolio design. Include:

- Clean water health solutions
- Hot water health solutions
- Smart bathroom health solutions
- Health massage solutions

**主要展品 /Products**

上海水护盾健康科技有限公司秉承“创新为你”品牌理念，通过多元产品组合设计，带来更全面的健康解决方案：

净饮水健康解决方案：包括净水器、净饮机、净水壶、龙头净水器及前置过滤器等，全屋健康用水

热水健康解决方案：包括电热水器、燃热水器及壁挂炉，更好解决热水需求

智能卫浴健康解决方案：包括智能马桶、花洒等产品，提供优越的卫浴体验

健康按摩的解决方案：涵盖了头部、眼部、肩颈、腰背、腿部按摩以及专业筋膜枪

Adhering to the brand concept of "Innovation for you", Shanghai Water Shield Health Technology Co., LTD brings more comprehensive health solutions through multi-product portfolio design:

Clean drinking water health solutions: including water purifier, clean drinking machine, clean kettle, tap water purifier and pre-filter, the whole house health water

Hot water health solutions: including electric water heater, hot water heater and wall mounted furnace, to better meet the hot water needs

Smart bathroom health solutions: including smart toilet, shower and other products, to provide superior bathroom experience

Health massage solutions: Covers head, eye, shoulder and neck, waist and back, leg massage and professional fascia gun

**上海松山电子有限公司****Shanghai Songshan Electronics Co., Ltd.****W5-5B43**

地址：上海金山工业区天工路 188 号

Add: No. 188, Tiangong Road, Jinshan Industrial Zone, Shanghai, China

电话 /Tel: 021-57277557

网址 /Web: www.songshanfuse.com

上海松山电子有限公司创建于 1958 年，是国内首家从事熔断器研发、生产企业，是中国航天宇航级（飞船、卫星、火箭等）星用熔断器指定供应商，也是全国小型熔断器标准委员会副主任单位。

松山产品包括管状熔断器、微型熔断器、SMD 熔断器、高压保险丝、宇航保险丝、军工保险丝、温度保险丝及自恢复保险丝等。松山产品生产完全符合 RoHS 指令和 REACH 法规要求。企业拥有数十项各类专利，管理体系认证和产品安全认证齐全。

Founded in 1958, Shanghai Songshan Electronics Co., Ltd. is the first enterprise engaged in fuse research and development and production in China. It is a designated supplier of aerospace grade (spacecraft, satellite, rocket, etc.) satellite fuses for China, and also a deputy director of the National Miniature Fuse Standards Committee.

Songshan products include tubular fuses, micro fuses, SMD fuses, high-voltage fuses, aerospace fuses, military fuses, thermal fuses, and PTC fuses. The production of Songshan products fully complies with RoHS directives and REACH regulations. The company has dozens of various patents, complete management system certification and product safety certification.

**主要展品 /Products**

保险丝

Miniature Fuses

**上海颂道卫浴设备有限公司****SHANGHAI SODAO SANITARYWARE EQUIPMENT CO.,LTD****E2-2A45**

地址：上海市宝山区南蕰藻路 408 号栋森科技园 9 号楼 1-2 号

Add: 1-2, Building 9, Donglin Science Park, No. 408 Nanwunzao Road, Baoshan District, Shanghai

电话 /Tel: 13391099411

传真 /Fax: 021-36337576

网址 /Web: www.sodaochina.com

上海颂道卫浴设备有限公司是一家专注于水领域“FOCUS ON WATER”，为企业提供水路系统专业解决方案，着力打造成为行业领袖品牌的资深的水终端产品供应商。公司主要生产不锈钢编织软管、净水器热水器专用不锈钢波纹管、淋浴花洒软管、角阀等产品，产品涉及净水、卫浴、电器、医药等多行业。我们集中优质产业资源，整合优质资源，以上海为公司总部，阀门之都玉环为生产基地，建立全面营销体系服务的全球格局。

Shanghai sodao sanitaryware equipmen co.,ltd is a company specializing in the field of water FOCUS ON WATER,water systems for the enterprises to provide professional solutions, focus on playing a brand of senior industry leaders to end the water supplier company mainly produces stainless steel wire braided water hose, shower hose, water purifier special stainless steel bellows, angle and other products, products related to sanitary ware, ceramics, water, electrical, automotive, pharmaceutical and other industries, we focus on high-quality chain products, integrating high-quality resources, with shanghai as the headquarters and in yuhuan, zhejiang, ningbo has established production bases in the same time, we rely on a number of strategic partners to provide customers with global multi-national certification requirements for products, such as germanyDVGW, the u.s.NSF&CUPC,Australia WATERMARK,british WRAS,the EU' CE& ROHS and so on

**主要展品 /Products**

不锈钢波纹管 不锈钢编织管 角阀 水龙头 减压阀 等等

**上海肃菲电子科技有限公司****ShangHai SUP Electronic Technology CO., LTD****W2-2A37**

地址：上海市青浦区华隆路 1788 号

电话 /Tel: 021-59780209

网址 /Web: www.supfuse.com

肃菲电子科技有限公司 (SUPfuse) 成立于 2018 年 1 月,是一家专业从事电路保护元器件研发、生产、销售于一体的高新技术企业,其产品涵盖过温保护 (热熔断体 TL); 过压保护 (热保护型压敏电阻半导体 TLMOV); 智能保护 (受控熔断器 TLiPD)。每个产品都有自己独特的核心技术和独立的知识产权。其产品通过了 CCC、UL、CUL、TUV、PSE 认证。广泛应用于通讯领域、照明领域、新能源领域以及家电领域。

**主要展品 /Products**

温度保险丝; 热保护型压敏电阻; 受控熔断器

Thermal-Link ;

Thermal Link & MOV (TLMOV) ;

Thermal Link idea Production Device (TLiPD)



**上海通业轻工制品有限公司****E2-2B40 2B41 2B42****Shanghai Toye light industrial products Co., Ltd**

地址: 上海市虹口区曲阳路 910 号复城国际商务中心 11 号楼 305 室 (200437)

Add: Room 305, building 11, Fucheng international business center, 910 Quyang Road,  
Hongkou District

电话 /Tel: 021-65316128

传真 /Fax: 021-65316128

网址 /Web: <http://www.eporas.com>

上海通业轻工制品有限公司创立于 2004 年, 是一家集中高端家居厨房用品自营进出口、生产、销售于一体的企业, 公司主营类目为铁锅、珐琅锅及陶土锅等厨房家居用品, 代理“EPORAS 八奈司”、“富士琺瑯 FUJIHORO”、“MIYAWO 宫尾”等日本一线品牌。

公司秉承“以诚信求信誉, 以服务求市场, 以品质求生存, 以创新求发展”的经营理念, 与您一起携手缔造实用, 节能, 环保, 时尚, 安全的家居厨房用品新概念时代。

Founded in 2004, Shanghai Tongye light industrial products Co., Ltd. is an enterprise integrating self import, export, production and sales of high-end household kitchen products. The company's main categories are kitchen household products such as iron pot, enamel pot and clay pot, and acts as an agent for Japanese first-line brands such as "eporas banaisi", "fujihoro enamel" and "miyawo miyao".

Adhering to the business philosophy of "seeking credibility with integrity, seeking market with service, surviving with quality and developing with innovation", the company will join hands with you to create a new concept era of practical, energy-saving, environmental protection, fashion and safety household kitchen products.

**主要展品 /Products**

铁锅、珐琅锅、陶土锅

Iron pot, enamel pot, clay pot

**上海同温层智能科技有限公司****E1-1G61**

地址: 上海市徐汇区云锦路 600 号 A 座 507-508 室

电话 /Tel: 02133682812

上海同温层智能科技有限公司是一家高新科技企业, 公司具有业界领先的基于人工智能的各类解决方案的设计、研发和实施能力, 研发了多种针对不同应用场景的系统解决方案, 致力于成为人工智能应用场景落地的领导者。

公司于 2020 年创立净小主 (ZEROMESS) 品牌, 专注智能家居清扫机器人自主研发设计与生产, 以低调、专注的钻研态度, 为用户打磨实用、创新、卓越的智能产品。

**主要展品 /Products**

净小主 Z1 集干扫湿拖、自主集尘、自动清洗拖布于一体, 独家首创双吸口设计, 配戴 253.7 纳米深紫外除菌, 采用 SLAM 路径规划 +AI 视觉避障, 搭载 5100Pa 超大吸力, 运用 8000 毫安超长续航电池, 搭配易撕胶囊型清洁液, 智能 APP 随心操控。

**Mamibot****上海团宝智能科技有限公司****E1-1G81****Mamibot Manufacturing (Shanghai) Co., Ltd.**

地址: 上海市普陀区曹杨路 1040 弄中友大厦 1 号楼 21 层北 (200333)

Add: 21st FL, No 1st, LN1040 Caoyang Rd, Shanghai, P.R.C.

电话 /Tel: 02162147369

网址 /Web: [www.mamibot.com](http://www.mamibot.com)

上海团宝智能科技有限公司主要生产扫地机、擦窗机、洗地机、无线手持吸尘器智能清洁家电。

Founded in 2013 in the field of intelligent and environmental home appliances, and incorporated in 2015 with headquarter in Delaware, USA, Mamibot Manufacturing USA Inc. is dedicated to designing and manufacturing robots that can perform as intelligently as, or even outperform humans on household chores. Mamibot provides a wide range of home cleaning robots, inside and out, including vacuum cleaners, window cleaners, other innovative floor cleaners like unique cordless electric mop with multiple functions including mopping, polishing, scrubbing, waxing, and mowers, etc. We have a great vision of saving you from all-around tedious chores.

**主要展品 /Products**

扫地机、擦窗机、洗地机、无线手持吸尘器、电动拖把、除螨仪

Robot vacuum cleaner, floor wahser, window cleaning robot, cordless stick vacuum, electric mop.

**Fantasyhome**  
匠小家**上海瓦雳智能科技有限公司****N4-4B35****Shanghai Wali Intelligent Technology Co., Ltd**

地址: 上海市奉贤区平庄西路 1599 号

电话 /Tel: 15618891232

网址 /Web: [www.ifantasyhome.com](http://www.ifantasyhome.com)

上海瓦雳智能科技有限公司, 是一家致力于智能家居, 美好生活的科技初创企业, 我们秉承“易生活, 享生活”的宗旨, 为广大消费者提供高品质的科技产品, 创造舒适生活新高度。

**主要展品 /Products**

智能打包换袋垃圾桶和自动感应消毒垃圾桶

**TERNCY 小燕科技****上海小燕科技有限公司****W3-3C71**

地址: 上海市浦东新区盛夏路 666 号 E 栋 502 (201210)

电话 /Tel: 021-50331028

传真 /Fax: 021-50331028

网址 /Web: <https://www.xiaoyan.io/zh-cn/home/>

小燕科技成立于 2015 年, 致力于打造安全稳定的智能家居系统产品。“旧时王谢堂前燕, 飞入寻常百姓家”, 小燕相信智能家居的普及会为每一个家庭带来愉悦的生活体验。目前小燕旗下拥有完善的智能家居系统产品, 涵盖安防, 灯光控制, 电源控制, 窗帘电机等产品, 并全部获苹果 HomeKit 认证。小燕智能家居系统支持主流智能音箱语音控制: 苹果 HomePod, 天猫精灵, 小度, Amazon Alexa 等。

**主要展品 /Products**

银凤 Pro 朱雀 凤凰 青鸾 白鹭 蓝鹊 开关模块 无线开关 感应开关 白鹭无线开关 双向人体传感器 人体传感器 存在传感器 门磁 智能窗帘电机 智能卷帘电机 智能梦幻帘 中央空调网关 毕方智能吸顶灯 毕方 Pro 智能吸顶灯 毕方防眩智能筒灯 毕方智能射灯 毕方磁吸轨道灯 精工磁吸轨道灯 精工智能灯泡 智能灯座 孔雀灯带 孔雀恒压调光驱动 精工智能调光驱动 奥丁全自动智能门锁 宙斯全自动智能门锁

**上海芯美电子科技有限公司**  
**Shanghai Xinmei Electronic Technology Co.,Ltd.**

W4-4A35

地址: 上海市松江区方泗路 18 号 1 号楼 605 室  
电话 /Tel: 13916104252

公司成立于 2004 年, 是一家致力于国内外知名品牌电子元器件营销代理、方案设计为主的专业化公司。为了更好的服务于衡器、POS、税控、物联网市场, 本公司可提供数据采集 A/D 数据转换芯片、单片机、显示驱动芯片、稳压电源芯片、热敏打印机芯、无线模组、数据传输接口芯片、逻辑芯片、GPRS 模块、CDMA 等器件。同时提供完善的技术支持及完整的应用解决方案, 为使客户能更快捷的迎合市场需求并将产品提前上市。

**主要展品 /Products**

A/D 数据转换芯片、单片机、显示驱动芯片、稳压电源芯片、热敏打印机芯、无线模组、数据传输接口芯片、逻辑芯片、GPRS 模块、CDMA 等器件

**上海芯垣电子科技有限公司**  
**Shanghai Xinyuan Electronic Technology Co.,Ltd**

E2-2A01

地址: 上海市闵行区颛桥镇颛兴东路 1559 号山谷 you 帮大厦二层 A 座 (201109)  
Add: Building shangyoubang, no. 1559, east Zhuanxing road, Zhuanqiao town, Minhang district, Shanghai  
电话 /Tel: 02154386653  
传真 /Fax: 021-54386919  
网址 /Web: www.xinyuanet.com

上海芯垣电子科技有限公司是一家专业提供物联网传感器和元器件, 智能硬件及云数据传输服务的技术型企业, 专注于物联网传感器采集及数据服务。芯垣电子以专业的传感器以及芯片应用设计的背景为客户提供相应的物联网前端数据采集方案。通过对物联网项目中多项参数的数据采集, 将影响我们生活和工作的多项环境因子和机器数据转化为大众可理解的信息, 从而形成切实可行的物联网网络。

Shanghai Xinyuan Electronic Technology Co., Ltd. is a professional iot sensors and components, smart hardware and cloud data transmission services technology-based enterprises, specializing in iot sensors, sensor acquisition and data services. Core electronic professional sensors, and chip application design background to provide customers with the corresponding internet of things, the end of the data acquisition program. Through the data collection of many parameters in the Internet of things (Iot) project, many environmental factors and machine data that affect

our life and work are transformed into the information that can be understood by the public, thus forming a feasible iot network.

**主要展品 /Products**

传感器类: 压力传感器, 气体传感器, 温湿度传感器, 霍尔传感器, 地磁传感器

芯片类: MCU, 隔离电源, AC-DC, DC-DC, LDO, 运放, 比较器, ADC, DAC, 接口器件, 保护器件, FPGA, MOS, 固态高分子电容, 电机驱动, 锂电池充电管理, 锂电池保护, 锂电池快充, 触摸

SENSORS: pressure sensors, gas sensors, temperature and humidity sensors, Hall Effect Sensor, geomagnetic sensor chips: MCU, isolated power supply, AC-DC, DC-DC, LDO, op amp, comparator, ADC, DAC, interface devices, protection devices, FPGA, Mos, solid st

**上海欣日科技股份有限公司**  
**SHANGHAI YOUNG SUN SCIENCE&TECHNOLOGY CO.,LTD**

W3-3B46

地址: 上海市长宁区愚园路 1258 号 1212 室  
电话 /Tel: 021-51688938

欣日科技成立于 1998 年, 是东芝、铠侠在华的最早本土合作伙伴之一, 及 YAMAHA、SANREX 和北陆等国际品牌合作伙伴。自 2016 年起, 引进补充了国产半导体, 为客户提供全方位的输入输出, 电源管理, 功率器件, 主控芯片, 存储, 传感器等各类电子零部件。全方位服务于家电行业、汽车电子和物联网行业, 以及通讯、医疗设备、安防监控等多元化的客户群体, 且可以为客户提供方案开发, OEM 制造等增值业务, 以及咨询业务。

**主要展品 /Products**

方案开发, 电子元器件销售

**上海馨源电子有限公司**

E1-1B40

地址: 上海市普陀区华池路 58 弄 5 号楼 101 室 (310000)  
电话 /Tel: 021-62041956  
传真 /Fax: 021-62042259  
网址 /Web: www.xinyuandianzi.com

上海馨源电子有限公司 -- 专业从事温度保险丝生产 35 年; 中国熔断器标准化技术委员会小型熔断器分技术委员会委员单位, 前身为上海无线电一厂。自 1980 年始, 馨源电子开始专业制造热熔断体 (温度保险丝), 至今已逾五十年。

**主要展品 /Products**

目前公司所生产的三元牌 RY、RH 两大系列热熔断体产品已先后获得了中国 CCC、美国 UL、德国 TUV Rheinland、日本 PSE、韩国 KC 等多国认证, 同时亦符合欧盟 CE 及 RoHS 指令的要求。

**aquapick® 牙酷牙碧™****上海牙酷牙碧科技有限公司**  
**aquapick technology co.,ltd.**

地址: www.aquapick.com

电话 /Tel: 021-54321557

传真 /Fax: 021-54281981

牙酷牙碧株式会社专注于家庭口腔健康护理产品的研发、生产和销售。通过 10 多年的努力,在韩国已成为家庭口腔健康护理市场中的领导者。我司出品的牙酷牙碧冲牙器可以有效防止龋齿和各种牙龈炎症,而且使您感受刷牙无法体会到的百分百的清洁效果。

我们承诺不断开发新产品,以保护全民口腔健康为使命继续努力。

**主要展品 /Products**

冲牙器, 电动牙刷

**W3-3A46****上海养贞轴承制造有限公司****Shanghai Lily Bearing Manufacturing Co.,Ltd.**

地址: 上海市闵行区元江路 525 号 6 号楼 301 室

Add: Room 301,6st Block, #525 Yuanjiang Road, Minhang District, Shanghai, China

电话 /Tel: 15801788053

上海养贞轴承制造有限公司(原名为烈力轴承)成立于 2000 年 9 月。它是一家领先的精密滚动轴承和零部件供应商,服务于全球市场。养贞轴承总部设在上海,在上海设有销售和服务办事处。目前公司已在美国和中国注册了 LILY® 和烈力® 轴承商标。

Shanghai Lily Bearing Factory Co., Ltd. (formerly known as Lily Bearing Manufacturing Co., Ltd.) was established in September 2000. It is a leading supplier of precision rolling bearings and components, serving the global market. Lily Bearing is headquartered in Shanghai. Currently the company has registered LILY® and Lily® bearing trademarks in the United States and China.

**主要展品 /Products**

微型轴承、薄壁轴承、法兰轴承、平面推力球轴承

**E1-1A30****上海烨映微电子科技股份有限公司****Shanghai Sunshine Technologies Co., Ltd**

地址: 上海市徐汇区桂平路 481 号 16 号楼 5 层 (200233)

电话 /Tel: 02164263818

传真 /Fax: 02151862418

网址 /Web: www.yysensor.com

烨映微电子是从事热电红外传感与 CMOS-MEMS 产品开发的国家专精特新集成电路芯片企业。依托 CMOS-MEMS 工艺平台,我们推出了红外热电堆传感器产品,是热电红外方面的“中国芯”;我

**N2-2A26**

们还开发了 SLC 硅电容、纳米微针等产品。我们拥有热电堆 MEMS 特色工艺及晶圆级先进封装能力,在提高产品集成度的同时兼顾了性能与成本,在智能家居、可穿戴、医疗、气体检测、能源安防、光通信、科技护肤领域具有广阔应用前景。

Shanghai Sunshine Technologies Co., Ltd is engaged in thermoelectric infrared sensing and CMOS-MEMS product development of the national specialized special new integrated circuit chip enterprise. Relying on the CMOS-MEMS process platform, we have launched infrared thermoelectric reactor sensor products, which are the "Chinese core" in thermoelectric infrared. We have also developed SLC silicon capacitors, nano-microneedles and other products. We have the characteristics of thermoelectric MEMS technology and wafer-level advanced packaging capabilities, which not only improve product integration but also take into account performance and cost, and have broad application prospects in smart home, wearable, medical, gas detection, energy security, optical communication, technology and skin care fields.

**主要展品 /Products**

MEMS 红外热电堆传感器芯片为公司 MEMS 红外热电堆传感器的核心部件,主要包括单点芯片和阵列芯片,应用场景包括智能家居、额温枪、耳温枪、工业测温仪、手机、智能穿戴等。

MEMS infrared thermopile sensor chip is the core component of the company's MEMS infrared thermopile sensor, which mainly includes single point chip and array chip. The application scenarios include smart home, frontal temperature gun, ear temperature gun, industrial thermometer, mobile phone, smart wear, etc.

**上海一分贸易有限公司**

地址: 上海市普陀区交通路 4711 号李子园大厦

电话 /Tel: 18201995772

华督智能: 专注健康智能小家电, 主营即热式饮水机、破壁机、养生壶等, 以水加热系列为主。

**主要展品 /Products**

华督智能: 专注健康智能小家电, 主营即热式饮水机、破壁机、养生壶等, 以水加热系列为主。

**N1-1B35****上海伊柯林技术有限公司****Shanghai Ikelin Technology Co., LTD**

地址: 上海市青浦区华新镇华隆路 1777 号 E 通世界华新园 G 座 1302 室 (201708)

Add: Room 1302, Block G, E-Tong World Huaxin Garden, 1777 Hualong Road, Huaxin Town, Qingpu District, Shanghai

电话 /Tel: 021-31169058

传真 /Fax: 021-31169058

网址 /Web: <http://www.china-evenclean.com/>

上海伊柯林技术有限公司是一家专业从事抗菌、防霉、防螨、等功能新材料自主研发、应用的技术性企业。

**E1-1A14**

以 EvenClean 品牌为基础,深度迎合生态优先、绿色发展的经济之路。为广大客户提供健康、安全、环保、绿色的全新开发方向。

Shanghai Ikelin Technology Co., Ltd. is a technical enterprise specializing in the independent research and development and application of antibacterial, mildew, mite and other functional new materials. Based on EvenClean brand, deeply cater to ecological priority, green development of the economic road. To provide customers with health, safety, environmental protection, green new development direction.

Related industries: construction, automobile, medical and health, coatings, plastics, aquatic products, spinning, etc. The company with professional technology, sales team, more than 10 years of segmented market application experience. Able to quickly and accurately provide customers with a series of professional and effective solutions; Guide customers to establish antibacterial, mildew, mite and other industrial systems.

#### 主要展品 /Products

上海伊柯林技术有限公司主要供应防霉剂, 银离子抗菌剂, 铜离子抗菌剂, 锌离子抗菌剂。  
Shanghai ikelin technology Co., Ltd. mainly supply mildew inhibitor, silver ion antibacterial agent, copper ion antibacterial agent, zinc ion antibacterial agent.



#### 上海亿力电器有限公司 Shanghai YILI Electric Co., Ltd

E1-1C11

地址: 上海市 闵行区 向阳路 1318 号 (201108)

Add: No. 1318 Xiangyang Road. Minhang District, 201108 Shanghai, China

电话 /Tel: 400-920-8866

传真 /Fax: 400-920-8866

网址 /Web: www.yilichina.cn

1999年正式成立,是一家集研发、生产、销售于一体的高新技术企业。产品涵盖高压清洗机、吸尘器、消杀设备、蒸汽清洁、锂电清洁等清洁电器,远销80多个国家和地区。公司还通过了ISO9001质量管理体系等一系列资质认证,并获得“高新技术企业”称号。公司秉承“诚信、协作、求真、务实、创新”的价值观,以“专业智造,成就价值”为使命,努力为全球消费者提供更好清洁方案和清洁产品。

Shanghai Yili Electric Co., Ltd. was officially established in 1999, is a high-tech enterprise integrating R&D, production and sales. Our products cover high-pressure cleaners, vacuum cleaners, disinfection equipment, steam cleaning, lithium cleaning and other cleaning appliances, which are exported to more than 80 countries and regions. The company has also passed a series of certifications such as ISO9001 quality management system and has been awarded the title of "High-tech Enterprise". The company adheres to the values of "Sincerity, Collaboration, Factualism, Pragmatism, Innovation", and takes "Professional and Intelligent Manufacturing creates Value" as its mission, and strives to provide better cleaning solutions and cleaning products for global consumers.

#### 主要展品 /Products

吸尘器、蒸汽拖把、布艺清洗机、电动拖把、洗地机、高压水枪。  
vacuum cleaner, steam cleaner, spot cleaner, electric mop, wet and dry vacuum cleaner, high pressure washer.



#### 上海印梦智能科技有限公司 Shanghai Prindream Intelligent Technology Co., Ltd.

W4-4B47

地址: 上海市松江区九新公路 865 号漕河泾信颐科技产业园 A 幢 6 楼 (201612)

Add: 6th Floor Building A No.865 Jiuxin Rd., Shanghai, China

电话 /Tel: 400-8210-429

传真 /Fax: 021-6091 7886

网址 /Web: www.yinmengyuan.com

上海印梦智能科技有限公司致力于为各行各业的创造者(包括设计师、科研人员、工程师、学生、创客等)提供在线 3D 打印、3D 建模设计、3D 扫描逆向和建模软件社区交流等服务。目前可打印的材料包括光敏树脂、PLA、ABS、尼龙、玻纤、金属和陶瓷等,广泛用于快速成型手板、产品开发、设计验证、关键功能部件制作、小批量生产等。我们专注 3D 打印多年,已累计打印零部件 40W+, 服务客户 5W+, 在客户中积累了良好的口碑。

Shanghai Prindream Intelligent Technology Co., Ltd. is committed to providing online 3D printing, 3D modeling design, 3D scanning reverse and modeling software community communication services for creators from all walks of life (including designers, researchers, engineers, students, makers, etc.). At present, printable materials include photosensitive resin, PLA, ABS, nylon, glass fiber, metal and ceramic, etc., which are widely used in rapid prototyping handboards, product development, design verification, key functional parts production, small batch production, etc. We have been focusing on 3D printing for many years. We have printed more than 40W spare parts and served more than 5W customers, which has accumulated a good reputation among customers.

#### 主要展品 /Products

3D 打印服务、3d 扫描服务、3d 设计服务、金属零件定制、塑料产品定制等  
3D printing services, 3D scanning services, 3D design services, metal parts customization, plastic product customization, etc

Yongxing  
ELECTRONIC

#### 上海永星电子开关有限公司 SHANGHAI YONGXING ELECTRONIC SWITCH CO., LTD.

W3-3A20 3A21

地址: 上海市松江区泗泾镇江河路 635 号 (201601)

Add: No.635, Jianghe Road, Sijing Town, Songjiang District, Shanghai

电话 /Tel: 021-57620011

网址 /Web: http://www.shykg.com/index.php

上海永星电子开关有限公司成立于 1985 年,是目前国内生产和销售机电开关、接插件等电器产品的著名厂商之一,本厂现有产品分九大类:按钮开关、船型开关、波动开关、接线端子、微动开关、冰箱门开关、指示灯、保险丝座、蜂鸣器等。产品广泛应用于电子、电器仪表、通信、音视频、家用电器、医疗器械等各领域。多年来本厂产品以优美的外观、绝佳的性能、稳定而可靠的质量以及完善的售后服务赢得了国内外用户的信赖。



Shanghai Yongxing Electronic switch Co., LTD. (Shanghai Yongxing Electronic switch Factory) was established in 1985. It is one of the famous manufacturers in the domestic production and sales of electromechanical switches, connectors and other electrical products. Our existing products are divided into nine categories: Pushbutton switch, boat switch, wave switch, wiring terminal, micro switch, refrigerator door switch, small button switch, indicator light, fuse holder, junction box, buzzer, etc., from which more than 4000 products can be derived. Products are widely used in electronics, electrical instruments, communications, audio and video, household appliances, medical equipment and other fields. Over the years, our products with beautiful appearance, excellent performance, stable and reliable quality and perfect after-sales service to win the trust of the majority of users at home and abroad.

#### 主要展品 /Products

按钮开关、船型开关、波动开关、接线端子、微动开关、冰箱门开关、小型钮子开关、指示灯、保险丝座、接线盒、蜂鸣器

Button switch, boat switch, wave switch, wiring terminal, micro switch, refrigerator door switch, small button switch, indicator light, fuse holder, junction box, buzzer



#### 上海筱样智能科技有限公司 Shanghai Uyang Intelligent Technology Co., Ltd.

E3-3E81

地址: 苏州市昆山市淀山湖镇新华路 28 号 8 栋 (200000)

Add: Building 8, No. 28, Xinhua Road, Dianshanhu Town, Kunshan City, Suzhou

电话 /Tel: 400-0011-132

传真 /Fax: 400-0011-132

网址 /Web: <https://www.vgo.top>

VGO 威狗吹风机 2017 年成立于上海, 创始人工程师背景, 深耕电子消费品十余年, 是科技部火炬计划科技型中小企业, 国家高新技术企业, 陆续获得国内外各类发明专利 40 余项。目前深耕单品类吹风机。

VGO 威狗吹风机是以科技呵护秀发健康为核心, 通过不断革新技术和产品, 赋予居家科技产品以温度, 让科技进步真正转化为生活的调味品, 共享科技美好生活。

诚邀渠道商, 零售商一起共话未来, 为消费者提供更优质的产品和服务。

VGO Hair Dryer was established in Shanghai in 2017. The founder has an engineer background and has been deeply involved in electronic consumer products for more than ten years. It is a technology-based small and medium-sized enterprise in the Torch Program of the Ministry of Science and Technology, and a national high-tech enterprise. It has successively obtained more than 40 domestic and foreign invention patents. At present, we are deeply cultivating single-category hair dryers.

VGO hair dryer is based on technology to care for hair health. Through continuous innovation of technology and products, it gives home technology products warmth, so that technological progress can truly be transformed into a spice of life, and share a better life with technology.

We sincerely invite channel dealers and retailers to discuss the future together and provide consumers with better products and services.

#### 主要展品 /Products

1、C1 负离子吹风机; 2、C3 高速吹风棒; 3、C8 智能高速吹风机; 4、S1 负离子直发梳; 5、M740 高速

无线吹风机; 6、S600 高速负离子吹风机; 7、M520 智能高速吹风机; 8、M990 立式吹风机; 9、S680 高速水离子吹风机

1、C1 Negative Ion Hair Dryer; 2、C3 High-speed Hair Drying Stick; 3、C8 Smart High-speed Hair Dryer; 4、S1 Negative Ion Hair Straightening Comb; 5、M740 High Speed Cordless Hair Dryer; 6、S600 High speed negative ion hair dryer; 7、M520 Smart High Speed Hair Dryer; 8、M990 Vertical Hair Dryer; 9、S680 High speed water ion hair dryer



#### 上海御牧贸易有限公司 MIMAKI

W5-5A11

地址: 上海市徐汇区桂平路 555 号 45 幢 1 楼 (200233)

电话 /Tel: 021-33676651

传真 /Fax: 021-33676656

网址 /Web: <https://shanghai.mimaki.com/>

Mimaki 集团创立于 1975 年, 总部位于日本长野县, 是一家独立研发、生产并向全世界销售工业级大幅面喷墨打印机的跨国集团公司。产品主要涵盖广告、工业生产、服装纺织、3D 打印等 4 个领域。在家电展中主推 MIMAKI UV 平板喷墨打印机, 其在家电行业类的打印领域主要包括: 薄膜开关、玻璃面板、塑料面板等打印。

#### 主要展品 /Products

UV 平板喷墨打印机 UJF-6042MKIIe, 可直接打印在玻璃、塑料等面板上, 进行家电各类彩色面板打印。



#### 上海志承新材料有限公司 SHANGHAI ZHICHENG NEW MATERIAL CO.,LTD

W4-4A14

地址: 上海市嘉定区马陆镇科盛路 1055 号 G 幢 (201801)

Add: Building G, NO.1055, Kesheng Rd, Jiading District, Shanghai

电话 /Tel: 021-52849941

传真 /Fax: 021-62507294

网址 /Web: [Http://www.sh-zccl.com](http://www.sh-zccl.com)

上海志承新材料有限公司成立于 2005 年 9 月, 拥有一批卓越领先的专业技术人员和多条先进的生产流水线, 具备薄膜丝网印刷, 高温高压 3D 成型, 冲切, 注塑等全过程的设计制造能力, 执行 TS16949 质量体系认证, 目前拥有 14 项国家专利技术, 并且获得高新技术企业证书。

Founded in September 2005, Shanghai Zhicheng new materials Co., Ltd. has a group of outstanding and leading professional technicians and several advanced production lines. It has the design and manufacturing capacity of the whole process of film screen printing, high temperature and high pressure 3D molding, punching and injection molding. It has implemented TS16949 quality system certification. At present, it has 14 national patented technologies, And obtained the certificate of high-tech enterprise.

#### 主要展品 /Products

家电 IMD 面板、薄膜开关、薄膜标贴、彩膜、汽车 2D/3D 仪表盘, 汽车 INS/IML 装饰件。



### 上海姿东智能科技有限公司

#### Shanghai Zidong Technology Co., Ltd.

地址: 上海市徐汇区虹漕路 88 号 H88 越虹广场 B 座 3 层 317

电话 /Tel: 02154661875

苏州欧圣电气股份有限公司成立于 2009 年 9 月 25 日, 经过 10 余年气动设备和清洁电器的 OEM/ODM 研发生产, 2022 年 4 月深交所创业板上市。上海姿东智能科技有限公司为苏州欧圣电气股份有限公司全资子公司, 姿东研发中心核心人员平均 10 年 + 家电行业从业经验, 目前 '清洁业务线 + 环电业务线 + 创新业务线' 三驾并驱, 在研项目有洗地机, 空净, 除湿机, 风扇, 制氧机等品类。

Suzhou Alton Electrical & Mechanical Industry Co., Ltd. was established on September 25, 2009. After more than 10 years of OEM/ODM research and production of pneumatic equipment and cleaning appliances, it was listed on the GEM of Shenzhen Stock Exchange in April 2022. Shanghai Zidong Intelligent Technology Co., Ltd. is a wholly-owned subsidiary of Suzhou Ousheng Electric Co., Ltd. The core personnel of Zidong R&D Center have an average of 10 years of experience in the home appliance industry. Currently, the "cleaning business line+environmental power business line+innovative business line" drive three parallel vehicles. The projects under research include floor washers, air cleaners, dehumidifiers, fans, oxygen generators, and other categories.

#### 主要展品 /Products

洗地机、洗地机器人、无叶净化风扇等。

Wet dry vacuum cleaner, floor washing robots, leafless purification fans, etc.



### 上品健康科技 (广东) 股份有限公司

#### Topg Health Technology(Guang Dong)Co.,Ltd

地址: 中山市火炬开发区科技西路 32 号 (528437)

Add: No.32 west science and technology road,torch development zone,zhongshan city.

电话 /Tel: 0760-22508319

传真 /Fax: 0760-22508316

网址 /Web: Http:www.topg-filter.com

上品公司成立于 2008 年, 专业生产和销售空气过滤器, 集产品设计、研发、生产和销售于一体。

公司地址中山市火炬高新技术开发区, 工厂建筑面积 30000 平方米, 400 多名员工。

我司所有产品采用国际质量标准, 已通过 ISO9001、ISO14001 和 IATF16949 和 ISO13485 认证, 实验室通过 CNAS 认可。

The company was founded in 2008, specializing in the production and sales of air filters, integrating product design, research and development, production and sales. The company is located in Zhongshan Torch High and New Technology Development Zone, with a factory construction area of 30000 square meters and over 400 employees. All our products adopt international quality standards, have passed ISO9001, ISO14001, IATF16949, and ISO13485 certifications, and our laboratory has passed CNAS accreditation.

#### 主要展品 /Products

W4-4A53

W1-1A12

## 参展商名录 (按字母排序) / Alphabetical List of Exhibitors

空气净化器、消毒机, 空气净化器 hepa 滤芯, ESP 高压静电模块

Air purifier, disinfection machine, air purifier HEPA filter element, ESP high-voltage electrostatic module



### 尚屋 (上海) 科技有限公司

#### SHANG HOUSE (SHANGHAI) CO., LTD.

地址: 上海市松江江区中辰路 188 号 8 号楼 (201613)

电话 /Tel: 021-51282616

传真 /Fax: 021-51282616

网址 /Web: http://www.adawo.com

公司成立于 2012 年, 坐落在中国上海市 G60 科创走廊松江新城科技园, 由德国爱达屋科技 (中国) 有限公司联合创建, 是一家集研发、设计、制造、销售于一体的高科技企业; 公司提倡 "核心技术, 优化生活" 的企业理念, 致力人居环境优化, 人工智能理念为企业核心价值观的环境科技公司。

#### 主要展品 /Products

无耗材空气净化器、高转速电吹风



### 绍兴光彩显示技术有限公司

#### SHAOXING GUANGCAI DISPLAY TECHNOLOGY CO.,LTD

地址: 浙江省绍兴市越城区峨山路 167 号 (312000)

Add: 167 Chengshan Road, Yuecheng District, Shaoxing, Zhejiang, China

电话 /Tel: 86-575-88626657

传真 /Fax: 86-575-88649799

网址 /Web: www.smddisplay.com

本公司专业蓝白光插件数码管、贴片数码管。国家高新、创新基金、省级研发中心。三十条 ASM 自动线, 四条 Sony 高速 PCBA 贴片线, 十条 MUSASHI 的 SMD display 生产线, 还有配套模具车间和注塑车间。洁净车间一万五千平方。日产插件数码管二十万只, 贴片数码管五万只。主要配套白色家电、工业控制、航天以及 5G 设备, 产品主要配套国际跨国公司和国内上市公司。

We have imported world-class ASM equipment and Japan MUSASHI dispenser, and introduced advanced semiconductor production technology and management from Taiwan. Our company is specializing in producing 0.1 to 0.8 inch, 1 to 4 digits SMD 7 segment LED display, Alphanumeric LED display and custom LED display. Our Clients include Samsung, Turkey Semtech, PHILIPS, Huawei, BOE and other well-known domestic and foreign companies. Our company owns several patents for SMD 7 segment LED displays, national innovation fund projects, and the national SMD LED display industrialization base and other honors.

#### 主要展品 /Products

7 段贴片数码管, 字母贴片数码管, 一位、二位、三位、四位直插数码管, 字母直插数码管, 点阵, 尖头以及光条, 客制品。

7-Segment SMD Display, Alphanumeric SMD Display, 1-4 Digit 7-Segment Through-Hole Display, Dot Matrix, Bar Graph Array, Light Bar, Custom Special display.

E3-3D76

N4-4A17



### 深圳柏斯曼电子科技有限公司

E3-3A05 3A06

地址: 深圳市宝安区福永街道凤凰社区腾丰大道 184 号厂房 401、301、及 189 号 B 栋厂房 3 层、4 层  
电话 /Tel: 15220081686

2007 年成立于中国创新科技之都 --- 深圳, 是一家集研发、生产、销售、服务于一体的国家级高新科技企业, 2017 年中国新三板上市, 现有员工 1000 人左右。

主要产品围绕口腔大健康, 覆盖电动牙刷、冲牙器、电子口喷、智能口腔牙膏分散器皿、消毒杀菌产品, 为包括全球前三大品牌在内的合作伙伴提供 OTM 贴牌定制等口腔护理类产品定制服务。

#### 主要展品 /Products

电动牙刷、冲牙器、电子口喷、智能口腔牙膏分散器皿、消毒杀菌产品



SURCIMA

### 深圳赤马人工智能有限公司

E1-1F51

#### Shenzhen Red Horse AI Co., Ltd.

地址: 深圳市南山区粤海街道高新区社区高新南七道 20 号深圳国家工程实验室大楼 B701

电话 /Tel: 0755-23202202

网址 /Web: <http://redhorseai.com/>

深圳赤马人工智能有限公司创建于 2019 年, 是一家专注于家用机器人领域的创新研发型企业。被评为深圳市人工智能协会副会长单位。

作为一家创新机器人企业, 赤马拥有行业领先的核心算法与坚实的生产制造能力; 业务聚焦于智能扫地机器人、智能洗地机器人、智能家庭服务机器人等多个板块; 目前已累计申请专利近百项。

#### 主要展品 /Products

赤马洗地机 V7

内置上下水系统 3.0

时刻净水洗地, 效率提升 2 倍。

无需往复补水, 一次可清洁 120 平米, 一次出发, 全屋地面高效率洁净。



### 深圳厨艺科技有限公司

N3-3A17 3A18

#### Shenzhen Chuyi Technology Co., Ltd

地址: 深圳市南山区粤海街道高新区社区科技南路 18 号深圳湾科技生态园 12 栋裙楼 532

Add: Room 532, Block B, Building 12, Shenwan Bay Science and Technology Ecological Park,  
18 Science and Technology South Road, Nanshan District, Shenzhen City, Guangdong  
Province

电话 /Tel: 0755-26400840

网址 /Web: <https://www.chuyitech.com/>

深圳厨艺科技有限公司成立于 2018 年 1 月, 致力连接智能美食菜谱和机器自动化烹饪。

自主研发、制造家用智能烹饪机器人, 输出内容和运营解决方案, 为最终实现机器全自动烹饪惠及千家万户而努力。

智能厨房当务之急是自动化, 其次是智能化。

消费升级场景下, 要减低用户下厨的启动成本, 增强下厨成就感, 幸福感。

“厨艺不足科技补”, “不用动手就好吃”。

#### 主要展品 /Products

一、烹小仙智能烹饪机器人: 是一款为解决厨房油烟、不会做菜、厨房小家电多、健康饮食方式、合理使用零碎化时间而诞生的高度自动化厨房健康电器。

二、开关磁阻电机: 独家自主研发的专利电机电控技术, 提供瞬时高低速正反切换的花样动力。

三、机械臂 + 烹小仙智能烹饪机器人整体厨房自动化解决方案: 通过自动识别完成多样复杂的自动化烹饪任务, 多机联动高效率, 实现自动清洗、烹饪、取餐等, 完成真正的无人值守烹饪。



### 深圳大事件科技有限公司

E3-3A23 3A24

#### Shenzhen Bigcase Technology Co., Ltd

地址: 深圳市龙岗区坂田街道象角塘社区雪岗路 1067 号城市山海云汇 D 栋后一栋一层 (518000)

Add: 1/F, building E, Chengshishanhai Yunhui, No.1067, Xuegang Rd, Bantian Street, Longgang  
District, Shenzhen, Guangdong Province, China

电话 /Tel: 0755-23325448

传真 /Fax: 0755-23325448

网址 /Web: [www.something.net](http://www.something.net)

向物是专注于打造有品质的居家生活的创新品牌, 致力于为繁忙的都市人群带来轻量级、无负担的下班后居家体验, 并提供简洁、美观、实用的小家电产品供消费者选择。

SOTHING is an innovative brand that focuses on creating a quality home life. It is committed to bringing lightweight and burden free home experience after work to busy urban people, and providing simple, beautiful and practical small household appliances for consumers to choose.

#### 主要展品 /Products

夏季产品: 花语系列 - 风扇; 萌宠系列 - 风扇; 高端驱蚊系列。

冬季产品: 家居取暖; 办公取暖; 衣物烘干护理。

Summer products: flower language series - fan; Mengchong series - fan; High end mosquito repellent series.

Winter products: home heating; Office heating; Clothes drying care.



### 深圳朝典科技有限公司

**W5-5B26, W5-5B27**

地址: 深圳市宝安区沙井街道衙边社区南亭路 56 号 1 栋 1215 (518000)  
电话 /Tel: 15112315733

深圳深圳朝典科技有限公司坐落于深圳宝安, 成立于 2020 年, 主营以创新型小家电为主的产品研发与生产 / 销售为一体。有着一批 10 多年家电研发与生产的人员。参与着公司产品品质与生产的把控。公司着力于匠心精神, 不断的去精细打磨产品, 使产品使用性更符合客户需求。

#### 主要展品 /Products

冰淇淋机, 果蔬消毒机, 真空封口机

Ice cream machine, fruit and vegetable disinfection machine, vacuum sealing machine



### FENNESST.

梵尼诗

### 深圳梵尼诗留声机有限公司

**N4-4B42**

#### Shenzhen fennesty phonograph Co., Ltd

地址: 深圳市福田区盛唐大厦东座 15 楼 (518042)

Add: 15 / F, east block, Shengtang building, Futian District, Shenzhen

电话 /Tel: 400-065-1877

传真 /Fax: 400-065-1877

网址 /Web: www.fennesty.hk

梵尼诗是全球古典留声机领导品牌, 是 HiFi 留声机的开创者, 是国家大剧院收藏品牌、台湾金点设计奖品牌。

创办于 2005 年的梵尼诗留声机, 始终专注于留声机的研究、再造和创新, 不断思考和发掘其作为音乐媒介和情感载体的文化价值。

以博物馆思维重塑留声机的视听艺术, 透过沉浸式的音乐体验, 唤醒和延续个体的文化记忆与自由表达, 提供另一种突破庸常的可能。

#### 主要展品 /Products

留声机、黑胶唱片

phonograph, Vinyl Records



### 深圳国爱全电化智慧科技有限公司

**N3-3D71**

地址: 深圳市宝安区福永街道福永社区福海工业区二区 9 号 419 (528400)

电话 /Tel: 075521611727

网址 /Web: www.szgoai.com

深圳国爱全电化智慧科技有限公司是一家全球领先的全电化智慧厨电整体解决方案提供商。公司于 2020 年 7 月 1 日共同创立, 总部设立于深圳市宝安区。

2021 年 9 月国爱率先在深圳宝安成立等离子体研究院, 志在打造等离子体电火领域的领导者。

2022 年 11 月国爱中山制造中心成立, 并实现量产交付。

国爱致力于开启高质量、高性能、高安全性和节能环保的全电化厨电新时代, 为客户提供一站式全球领先的绿色能源厨电解决方案。

#### 主要展品 /Products

智能油烟机、蒸箱、烤箱、蒸烤一体机、洗碗机、电磁能热水器、厨余处理器、消毒柜、智能电饭煲、面包机、养生壶、空气炸锅等



### 深圳华星恒泰泵阀有限公司

**N4-4B12-1**

#### SHENZHEN CNHT COMPANY LIMITED

地址: 深圳市宝安区留仙一路甲岸科技园 1 栋 3 区 4 楼华星恒泰 (518101)

Add: Huaxing Hengtai, 4th Floor, Zone 3, Building 1, Jia 'an Science park, Liuxian 1st Road,

Bao 'an District, Shenzhen

电话 /Tel: 0755-27598327

传真 /Fax: 0755-26503793

网址 /Web: www.szcnh.com

深圳华星恒泰泵阀有限公司是一家以微型电磁泵阀相关技术为核心, 集产品设计、研发、制造、营销为一体的国家级高新技术企业, 公司拥有五十余项泵阀技术专利, 是中国较早研发制造微型电磁泵阀的企业, 同时也是全球较主要的微型电磁泵及电磁阀供应商之一。

Shenzhen huaxing hengtai pump valve co., LTD. Is a miniature electromagnetic valve related technology as the core, set product design, research and development, manufacturing, marketing as one of the state-level high-tech enterprises, the company has more than 50 patents of pump valve technology, is China's earlier research and manufacturing of micro electromagnetic valve enterprise, is also a major global supplier of micro electromagnetic pump and electromagnetic valve.

#### 主要展品 /Products

CNHT 微型泵, 蒸汽熨斗水泵, 扫地机微型泵, 料理机真空泵, 咖啡机水泵, 微型隔膜水泵, 微型电磁隔膜增压水泵, 微型气泵, 马达膜片泵, 微型水泵, 直流水泵, 咖啡机电阀, 蒸汽烤箱泵, 微型隔膜泵, 微型真空泵, 扫地机水泵, 15Bar 咖啡机泵, 19Bar 咖啡机泵, 高压咖啡机泵等。

CNHT micro pump, steam iron pump, sweeper micro pump, cooking machine vacuum pump, coffee machine pump, micro diaphragm pump, micro electromagnetic diaphragm booster pump, micro air pump, motor diaphragm pump, micro pump, Dc water pump, coffee mechanical valve, steam oven pump, micro diaphragm pump, micro vacuum pump, sweeper pump, 15Bar coffee machine pump, 19Bar coffee machine pump, high pressure coffee machine pump, etc.





**深圳洁盟技术股份有限公司**  
**SKYMEN SONIC GROUP LIMITED**

E2-2A44

地址: 深圳市宝安区福永街道会展湾中港广场 6 栋 B 座 1103-1106 (518000)  
电话 /Tel: 18929444681  
传真 /Fax: 0755-29784236  
网址 /Web: www.skymen.com.cn

深圳洁盟技术股份有限公司成立于 2007 年, 总部位于广东省深圳市福永区, 是“国家高新技术企业”, 专注超声波清洗机十四年, 行业内前三的清洗设备品牌商。自公司成立开始, 秉持“清洗机·洁盟造”的品牌理念, 拥有韶关制造中心 1.3 万 m<sup>2</sup> 生产基地、独立自主的深圳研发中心及深圳营销中心, 并完成规划打造下一代智能制造中心——韶关工业园。出口认证齐全, 产品目前远销海内外 200 多个国家和地区, 供货产能每月可达到 20W。

**主要展品 /Products**

家用超声波清洗机, 商用超声波清洗机, 工业用超声波清洗机, 医用仪器

可清洗物品:

眼镜、手表、金银首饰、钢笔、咖啡杯、茶具、水果、印章、奶瓶、奶嘴、咖啡杯、茶壶、水杯、酒杯、玻璃杯、CD/VCD/DVD 碟片、眼镜、项链、耳环、手镯、电子产品、手表、假牙、打印机墨头、剃须刀头、笔尖、牙刷、钱币、徽章、奶嘴、杯子、水果等物品。

**LDROBOT**

Move Smarter

**深圳乐动机器人股份有限公司**  
**SHENZHEN LDROBOT CO., LTD**

W4-4D86

地址: 深圳市南山区西丽街道国际创新谷 6 栋 A 座 16 楼  
电话 /Tel: 400-682-6829  
网址 /Web: www.ldrobot.com

深圳乐动机器人股份有限公司是专注于机器人移动感知技术自主研发和生产制造的国家级高新技术企业, 以“构建智能机器时代基础设施”为使命, 乐动以过硬的产品质量和多维度的持续创新, 基于全系列传感器、自研算法、云平台三大核心服务, 创新性研发出独有的机器人定位与导航技术, 可广泛应用于: 家庭服务机器人、商用机器人、无人机、工业机器人等应用场景。乐动始终站在机器人感知行业最前沿, 以创新驱动行业发展, 创造无限可能!

**主要展品 /Products**

- 机器人感知传感器: 三角激光雷达、DToF 激光雷达、固态线激光雷达、单点激光雷达、超声波传感器
- 人工智能算法: 机器人控制系统、机器人应用 + 云服务器
- Autopack 云平台



**深圳力干连接器有限公司**  
**Shenzhen Power Act Connectors Enterprises Limited**

N4-4B12-2

地址: 深圳市龙岗区宝龙街道丁甲岭同路工业区 B3 栋 (518116)  
电话 /Tel: 0755-84290482  
传真 /Fax: 0755-84293516  
网址 /Web: www.poweract.com.cn

力干成立于 1996 年, 专注于端子连接器、高温电线、线束加工的生产、销售服务。产品广泛应用于电水壶、咖啡机、烤箱、电饭煲等各类家用电器。力干始终坚持用高品质征服客户, 为客户提供全面的售前售后服务以及专业的技术支持。

力干在 ISO9001 与 ISO14001 质量和环境管理体系指导下, 严格按照国际标准进行生产检测, 产品已通过 UL、CUL、CSA、VDE、CCC、CQC、CB 等国内外认证。

Power Act was established in 1996, has focused on research, specializing in R&D, production, sales, service of terminals and connectors, high temperature lead wire, wire harness and processing equipment. Our products are widely used in home electrical appliances such as electric kettles, coffee makers, ovens, electric cookers, refrigerators, air-conditioners etc. We always adhered to high quality for customers, and engaged those customers with good service, provided customers with professional technical support and full service before & after sales. Power Act with advanced manufacturing and testing equipment, under the guidance of ISO9001 & ISO14001 quality and environmental management system, production is controlled in accordance with international safety standards. Products have International Certification such as UL, CUL, VDE, CSA, CCC, CQC.

**主要展品 /Products**

端子连接器、高温电线、线束及加工设备

terminals and connectors, high temperature lead wire, wire harness and processing equipment



**深圳丽白科技有限公司**  
**SHENZHEN LIBAI TECHNOLOGY CO., LTD**

E3-3D86

地址: 深圳宝安沙井第二工业区 73 号 3 楼 311

深圳丽白科技有限公司专注于开发高品质个人护理类产品。以创新设计为中心, 致力于以科技改善人们生活品质。通过不断推出更简洁, 更易用, 更专业, 更智能的产品, 来满足人们不断对品质生活的追求。目前, 旗下拥有品牌 Oday 致力于全年龄段的个人护理类产品的全周期运营, 如声波电动牙刷及个人日常护理类周边产品。公司为世界各地品牌提供及销售商提供创新设计、硬件制造等一站式解决方案。

**主要展品 /Products**

电动牙刷 冲牙器

electronic toothbrush waterflosser

宜宝  
neakasa**深圳尼宝科技有限公司**  
**Neakasa Tech Co., Limited**

E1-1C86

地址: 深圳市前海深港合作区前湾一路1号A栋201室(入驻深圳市前海商务秘书有限公司)(518000)  
电话 /Tel: 075526900494  
传真 /Fax: 0755-26900494  
网址 /Web: <https://neakasa.com>

宜宝 Neakasa, 新锐“家居清洁科技”品牌。

品牌立足全球发展, 商业版图遍布欧美、日韩等 60 多个国家地区。自成立以来, 品牌专研智能清洁产品, 获 49+ 项全球研发专利, 并多次荣登日韩清洁产品市场榜首, 国际媒体赞誉有加, 用户好评如潮, 是当之无愧的现代家庭清洁专家。

**主要展品 /Products**

品牌自成立以来, 秉持着“用创新的方式让世界更加清洁”的品牌使命与愿景, 专注研发智能清洁产品。目前产品已涵盖扫地机器人、智能洗地机、宠物高速吹水机、宠物毛发清洁一体机等, 并以“创新的技术”丰富的产品”和“优质的服务”, 收获了全球数百万用户的喜爱与认可。

**深圳前海西哲智能科技有限公司**

E1-1C71

地址: 佛山市南海区南国小商品城西哲体验馆  
电话 /Tel: 13923232317

日本株式会社西哲, 是一家专门开发和销售自主品牌“sezze”的日本中小家电企业, 与日本近数百家的客户有良好的合作关系, 如世界第二大的电器销售商山田电器、年销售额过千亿元位居全日本前列的 Cainz、上新电机、Beisia、Amazon 等都是其长期客户。

**主要展品 /Products**

空气循环扇, 稻田扇, DC 变频风扇, 多功能网红锅, 日系鸳鸯锅, 便携果汁机, 无线便携吸尘器, 按摩塑身仪, 小暖风机, 人感暖风机等等各种小家电

**深圳森选科技有限公司**  
**Shenzhen Sun Selection Technology Co., Ltd**

E3-3F76

地址: 深圳市宝安区石岩街道浪心社区梨园工业区拓邦工业园厂房2 5层 (518108)  
Add: 5F, WORKSHOP 2, TOPBAND INDUSTRIAL PARK, LIYUAN INDUSTRIAL PARK, SHIYAN STREET, BAO' AN DISTRICT, SHENZHEN  
电话 /Tel: 0755-27651888  
传真 /Fax: 0755-27651888  
网址 /Web: [www.sunselectiontech.com](http://www.sunselectiontech.com)

深圳森选科技有限公司, 是深圳拓邦股份有限公司旗下的子公司, 创立于 2020 年, 专注个护、健

康类电器产品。旗下拥有“品仕乐”品牌, “品仕乐”是中国个护/健康类电器新锐品牌, 通过关注当代青年生活层面的身心诉求, 挖掘出个护/健康类电器产品的细节需求, 注入能改善产品享受体验的暖心科技, 最终打造出高品质高美感的智能家电产品, 致力于给当代青年带来高品质、更便捷、更享受的智美生活体验。

Founded as a subsidiary of Shenzhen Topband Co., Ltd. in 2020, Shenzhen Sun Selection Technology Co., Ltd. focuses on health & personal care appliances and owns the brand “PINSHILE”. As the avant-garde of health & personal care appliances in China, PINSHILE commits to bring higher quality, more convenient and more enjoyable life experience to the contemporary youth through fine and aesthetic smart appliances by paying attention to their physical and mental appeals, polishing the details of health & personal care products, and injecting warm technology to improve customer experience.

**主要展品 /Products**

品仕乐手持立式吹风机, 于 2021 年 5 月正式上线, 是一款从结构到理念都突破了传统吹风机固有模式的创新产品。结构上, 采用新颖立式结构和独特的双出口设计, 一方面做到解放双手, 让用户告别手持吹发酸累; 另一方面, 采用双出口风保证大风量, 实现多面覆盖, 让干发更快更均匀。这两项创新结构已获得专利保护。理念上, 立式吹风机重新定义吹发方式, 为用户提供舒适的吹发体验, 让吹发成为一种享受, 进而提高生活幸福感。

PINSHILE Hands Free Upright Hair Dryer, officially launched in May 2021, is an innovative product that revolutionized the traditional hair dryer in both structure and concept. Structurally, it adopts the design of novel vertical structure and unique double air outlet grilles. Hence, on one hand, users can say goodbye to the hand-holding tiredness of hair drying and liberate their hands. On the other hand, the application of double air outlet grilles ensures large air volume and provides multi-faceted coverage, making the hair drying faster and more evenly-blown. To protect such innovations, these two pioneering structures have been granted patent protection. Conceptually, Hands Free Upright Hair Dryer redefines the way of blowing hair. It provides users with comfortable blowing experience, makes hair drying a kind of enjoyment, and then improves the happiness of life.

**深圳市爱博绿环保科技有限公司**

W1-1B13 1B14

地址: 深圳市龙岗区坂田街道万科城社区新天下百瑞达大厦 A 座办公楼 6F610 室  
电话 /Tel: 13682335762  
网址 /Web: <https://www.boolv.com/about>

爱博绿成立于 2016 年, 总部位于深圳, 是一家专业为企业提供环境保护及电子废弃物回收处理的集团公司, 具有完善物理处理系统、化学处理系统、环境保障系统全段工艺的专业废弃电器电子产品环保处理处置企业和国家高新技术企业。

我们已搭建覆盖全国的全面类“逆向物流网络”; 拥有 10 家分、子公司、4200 个回收网点、12 大分拣中心、2 家废弃电器电子产品的回收处理工厂及 13 家战略合作废弃电器电子产品的回收处理工厂。

**主要展品 /Products**

产品①: 博绿回收小程序, 信息整合软件, 让货源更集中, 已连接超过 56000 名导购;  
产品②: 博绿回收 APP, 抢单回收软件, 让回收更简单, 已连接超过 33000 名上门回收人员;  
产品③: 分拣中心, 仓储分拣软件, 让分拣更智能, 已在 340+ 分拣网点应用;  
产品④: 货源通小程序, 拆解端, 让交易更合规, 已在 13 家拆解企业及上百个大型网点应用。

**ANTOP®****深圳市安拓浦科技有限公司****SHENZHEN ANTOP TECHNOLOGY CO., LTD****W5-5B03 5B04**

地址: 深圳市宝安区燕罗街道燕川社区罗田林场龙侨华工业区厂房二 (301) (518105)

电话 /Tel: 4008080091

传真 /Fax: 020-38878000

网址 /Web: www.antop.com.cn

深圳市安拓浦科技有限公司起源于 1980 年, 是一家集研发、生产、销售和服务于一体的高新技术企业, 公司秉承“以创新技术护航人类健康”的企业使命, 成立空气质量技术研究所, 致力于打造市场最前沿的空气净化产品。围绕居家、办公、出行、医疗等生活场景, 成功研发空气净化、空气消毒等系列产品, 守护人类健康美好未来。

深圳市安拓浦科技有限公司起源于 1980 年, 是一家集研发、生产、销售和服务于一体的高新技术企业, 公司秉承“以创新技术护航人类健康”的企业使命, 成立空气质量技术研究所, 致力于打造市场最前沿的空气净化产品。围绕居家、办公、出行、医疗等生活场景, 成功研发空气净化、空气消毒等系列产品, 守护人类健康美好未来。

**主要展品 /Products**

家用空气净化器、车载空气净化器、烘干消毒毛巾机、空气消毒机、消毒棒

**深圳市百乐奇显示有限公司****Topovision Technology Co., Ltd.****E2-2A33 2A34**

地址: 深圳市南山区高新科技园北区朗山路 16 号华瀚创新园 C 座 201H (518057)

Add: Room201H, BuildingC, Huahan Innovation Park, No.16Langshan Road, High-techIndustryParkNorth, Nanshan District, Shenzhen 518057, China

电话 /Tel: 0755-86725320

网址 /Web: www.topo-vision.com

Topovision 拓扑逊科技有限公司成立于 2007 年, 是一家集研发, 设计, 生产, 销售液晶模组及显示解决方案于一体的国家高新技术企业。我们拥有全自动化生产设备及百 / 千级无尘生产车间, 可以提供定制、创新及成本效益型液晶显示模块的开发和制造。产品广泛应用于: 医疗设备仪器、车载仪表显示、工控智能设备、移动支付、智能家居、物联网、手持 PDA 设备、工业安防设备、多媒体数码等。

Topovision is the high-tech enterprise working closely with plenty of nearby factories and suppliers, we utilize our abundant global trading experience and technical LCD/LCM knowledge to help you in many ways:

- 1 Find the best and suitable source;
- 2 Complete panel total-solutions, technical support and design-in;
- 3 Offer the best delivery;
- 4 Offer the best price;
- 5 Support not only before orders, but also during manufacturing, and after sales.

We have focused on the design and manufacturing

small-medium size display module products for more than 13years; We are specialized in

developing, customizing on Mono, TFT, OLED display and driving board technologies, including the air-gap & optical bonding CTP (Projected Capacitive Touch screen).

**主要展品 /Products**

TFT 液晶显示屏、电容触摸屏、PMOLED/AMOLED、驱动转接板、串口 /DSI 集成模块。

Main products:

TFT LCD, capacitive touch screen, PMOLED / AMOLED, drive adapter board, serial port / DSI integrated module.

**安佰太****深圳市佰太科技有限公司****SHENZHEN BAITAI TECHNOLOGIES CO., LTD.****W5-5B22**

地址: 深圳市龙岗区龙城街道嶂背社区嶂背大道 181 号永昌隆第二工业区四楼 401 (518172)

Add: ROOM401 NO.181 ZHANGBEI ROAD, ZHANGBEI COMMUNITY, LONGCHENG STRESS, LONGGANG DISTRICT, SHENZHEN, CHINA

电话 /Tel: 0755-28282643

传真 /Fax: 0755-28282643

网址 /Web: https://aibaitai.1688.com

**主要展品 /Products**

小风扇、加湿器等电子产品

Small fan, humidifier and other electronic products

**深圳市宝嘉智能有限公司****N2-2A01**

地址: 深圳市宝安区石岩街道水田社区石龙仔金凯进工业园

电话 /Tel: 13510418083

网址 /Web: https://www.adiding.net.cn/

深圳市宝嘉智能有限公司是一家专业从事智能洗碗机产品研发、生产、销售、服务为一体的现代化高新技术企业, 拥有家的、adiding 两大品牌, 主营各种洗碗机产品, 在京东商城、天猫商城均有售卖, 商品好评率超过 98%。

宝嘉智能从消费者切实需求出发, 致力于研制出洗涤效果更好、能耗更低、更适合中国厨房的中高端洗碗机。

**主要展品 /Products**

水槽洗碗机、嵌入式洗碗机、水槽超声波洗碗机

**宾多康®****深圳市宾多康科技有限公司****ShenZhen Binduokang Technology Co.,Ltd**

地址: 深圳市龙岗区平湖街道禾花社区华南大道一号华南国际皮革皮具原料物流区二期 5F001-003 (518100)

Add: 5F001-003, 5F02, Phase II, Huanan International Leather Goods Raw Materials Logistics Zone, No.1 Huanan Avenue, Hehuashe District, Pinghu Street, Longgang District, Shenzhen 9-031.

电话 /Tel: 400-160-9228

传真 /Fax: 0755-21088367

网址 /Web: www.binduokang.com

Pentasmart (宾多康) 2015 年创立于中国深圳, 专注于便携式按摩器的研发、生产和销售。Pentasmart 奉行“轻松生活”的健康哲学, 旗下产品以智能便携、外观简约、体验舒适为特点, 迅速获得了用户的喜爱。产品至今已畅销中国大陆、中国台湾、中国香港、日本、美国、韩国、法国等 20 多个国家及地区, 其中颈部按摩器、膝盖按摩器、腰部按摩器、智能刮痧器等多个产品系列更是在中国大陆、日韩市场取得领先地位。

Pentasmart was founded in Shenzhen, China in 2015, focusing on the R & D, production and sales of portable massagers. Pentasmart pursues the health philosophy of "Relaxed life", and its products are characterized by intelligent portability, simple appearance and excellent user experience, which have quickly won the favor of users. Products have been sold in Chinese mainland, Taiwan China, Hongkong China, Japan, Korea, the United States, France and other more than 20 countries and regions, among which neck massagers, knee massagers, waist massagers, intelligent scrapers and other products are leading position in Chinese mainland, Japan and Korea market.

**主要展品 /Products**

头部按摩器、眼部按摩器、颈部按摩器、腰部按摩器、膝部按摩器、腿部按摩器、智能刮痧仪、筋膜枪、艾灸仪

Head massager, Eye massager, Neck massager, Waist massager, Knee massager, Leg massager  
Intelligent Gu Sha instrument, Fascia Gun, Moxibustion Apparatus

CSCK 齿时齿刻

**深圳市齿时齿刻科技有限公司****ShenZhen CSCK Technology Co., Ltd**

地址: 深圳市宝安区西乡街道共乐商业大厦 202B

电话 /Tel: 13530854590

网址 /Web: https://csck6688.1688.com

创立于 2020 年 6 月, 座落于改革先行示范区广东深圳宝安区。专注个人护理、口腔护理产品及周边产品的科研、生产、销售。“齿时齿刻”是一家以产品热销海内外的中国新兴品牌。齿时齿刻从“齿”出发, 提高中国人对口腔健康的重视, 全面改善国人的口腔健康。不断探索口腔护理新技术, 开发适合市场的口腔护理产品, 在不断创新的基础上, 研发出不同系列的产品, 拥有各国所需的出口认证及国内首创的 IPX8 防水级别证书。

**E3-3B10****E3-3B02**

Shenzhen CSCK Technology Co.,Ltd was established from June 2020. We are located in Shenzhen Baoan District, which is a reform and opening up pilot demonstration area. We mainly focus on Oral care& personal care products including the research, production and sale of peripheral products. "CSCK" is a Chinese new brand which sell our products to abroad and domestic market.

**主要展品 /Products**

专注冲牙器生产研发

**深圳市创启达科技开发有限公司****Shenzhen CQD Technology Development Co.,LTD**

地址: 深圳市宝安区沙井街道共和社区第三工业区恒昌荣 B3 栋 2 楼 (518001)

电话 /Tel: 13632686013

网址 /Web: http://www.szcqd.com

深圳市创启达科技开发有限公司, 成立于 2011 年。

是一家专注于智能控制器生产与研发的高科技企业, 创启达拥有领先的智能控温技术、智能电流电压功率控制技术以及完善的物联网大数据智能平台方案, 经过十余年的积累与创新, 一直领跑智能控制器行业。

同时, 企业拥有完备的生产体系和高品质的品控体系, 得到了国内外众多客户的认可。

**主要展品 /Products**

温度控制类智能电控板 (电子式水壶 / 咖啡机等)

电流功率控制类智能电控板 (自行车灯 / 汽车充电桩 / 电动工具等)

物联网智能家居云平台

**W1-1B23****深圳市创时代电子科技有限公司**

地址: 深圳市宝安区松岗街道东方社区田洋二路南边头科技园 A 栋

电话 /Tel: 13632708139

深圳市创时代电子科技有限公司, 成立于 2010 年, 是一家集研发、生产、销售为一体的高新技术企业, 公司主要产品有智能高频焊台、恒温焊台、热风返修拆焊台、焊锡机专用智能焊台、智能高频离子风机、离子风棒、离子风枪等电子工具及配件, 公司凭借雄厚的技术实力、高效的经营管理、完善的销售服务体系, 通过自主研发和引进国内外先进技术, 在无铅焊锡、静电消除方面赢得了广大客户的认同和信赖。

**主要展品 /Products**

智能无铅焊台、智能离子风机、离子风棒、ESD 实时监控系統、智能焊锡机器人、烟尘净化机等

**E3-3A31**



DECHENGWANG  
Fluoropolymer**深圳市德诚旺科技有限公司****W3-3A41 3A42****Shenzhen Dechengwang Technology Co., Ltd.**

地址: 广东省深圳市龙华区福城街道金恒润工业区 D 栋 2-3 层 (518110)

Add: Building D, Jinhengrun Industrial Park, Fucheng Street, Longhua District,  
Shenzhen, Guangdong

电话 /Tel: 0755-81755650

传真 /Fax: 0755-83722725

网址 /Web: www.dcwptfe.com

深圳市德诚旺科技有限公司, 创办于 2006 年, 是一家专业从事聚四氟乙烯制品 (又名 PTFE) 的工业企业, 产品广泛应用于五金、机械、电子、阀门、石油化工和航空等领域, 产品技术指标达到德国、美国、日本等先进工业国家的技术质量标准, 并坚持每年都更新的聚四氟乙烯的产品认证, 如 RoHS、FDA 等。

Shenzhen Dechengwang Technology Co., Ltd., founded in 2006, is an industrial enterprise specializing in PTFE products, serving in the industrial of hardware, machinery, electronics, valves, petrochemicals, aerospace, and so on. Product technical indicators achieve the technical standards of advanced industrial countries such as Germany, the United States, and Japan. And adhere to update the PTFE product certification every year, such as RoHS, FDA, etc.

**主要展品 /Products**

聚四氟乙烯波纹管、聚四氟乙烯球阀座、聚四氟乙烯定制环、聚四氟乙烯绝缘件、聚四氟乙烯密封件、聚四氟乙烯轴套

PTFE Bellows, PTFE Ball Valves Seats, PTFE Rings, PTFE Insulators, PTFE Seals, PTFE Bushings

**Pumps and Valves****深圳市德宇鑫科技有限公司****E1-1B13 1B14****Shenzhen Deyuxin Technology Co., Ltd**

地址: 深圳市龙岗区平湖镇辅城坳工业区长龙东路 21 号 (518111)

Add: No. 21 Changlong East Road, Pinghu Town, Longgang District, ShenZhen, China 518111

电话 /Tel: 0755-29533887

传真 /Fax: 0755-29537662

网址 /Web: http://www.dyxminiump.com

深圳市德宇鑫科技有限公司成立于 2007 年, 总部在深圳, 生产厂房面积约 1.5 万 m<sup>2</sup>, 现有 600 多名在职优秀员工。并于 2011 年在湖南常德德山工业园设立生产基地, 同年 10 月在香港成立德宇鑫实业有限公司。公司主营气泵、真空泵、水泵、活塞泵、电磁泵、气阀、水阀、电磁铁等, 广泛应用于医疗、大健康、母婴护理、卫浴、生活家电、清洁电器、消费类电器、美妆等产业。

Shenzhen deyuxin Technology Ltd. was established in 2007, mainly focusing on the field of microelectronics motor hydrodynamics, founded by industry experts. Inception of the starting

point in product quality, quality and service for business survival lifeline philosophy. Strict accordance with the ISO9001 quality management system operation, in October 2009 passed the ISO9001 quality system certification

**主要展品 /Products**

公司主营气泵、真空泵、水泵、活塞泵、电磁泵、气阀、水阀、电磁铁等, 广泛应用于医疗、大健康、母婴护理、卫浴、生活家电、清洁电器、消费类电器、美妆等产业

Air pump vacuum pump water pump piston pump solenoid pump air valve water valve

**Dual·帝而**

智能快捷料理炉

**深圳市帝而的客科技有限公司****N3-3H81**

地址: 深圳市南山区南头街道新豪方大厦 11H

电话 /Tel: 18902478094

网址 /Web: http://dualdik.com/

深圳市帝而的客科技有限公司成立于 1996 年, 是中国最具制造实力的全系列中高端厨房电器品牌经营者, 于 2016 年在深圳前海股权交易中心挂牌企业 (挂牌代码: 667935)。公司秉承“健康、时尚、简单”的价值理念, 专注中高端厨电行业超 20 年, 只为消费者提供健康、智能、易用、高端的厨房电器产品。

**主要展品 /Products**

时尚小家电, 嵌入式烤箱, 复古微波料理炉, 颜值小家电, 厨电三件套冰洗系列

**深圳市帝拓电子有限公司****E3-3A40****Shenzhen Dituto Electronic.**

地址: 深圳市宝安区新桥街道黄埔社区黄埔东环路 372 号 (518125)

Add: No.372 Donghuan Rd. Shajing, Baoan, Shenzhen, China 518125, Shenzhen,  
Guangdong, China

电话 /Tel: 18665965389

网址 /Web: http://www.sz-dituto.com.cn/

深圳市帝拓电子有限公司成立于 2011 年 2 月, 位于深圳宝安, 占地面积 16000 平方米, 拥有 200 名经验丰富的工人, 月产量 30 万台。帝拓电子拥有 10 年的香薰加湿, 真空保鲜产品生产经验, 是香薰机, 加湿器, 扩香仪, 纳米美容仪, 空气净化器, 真空泵和真空保鲜盒的专业生产商。我们从不能满足, 持续学习新的知识和技术导入我们的产品, 为客户提供一站式服务, 满足客户的需求。

Shenzhen Dituto Electronic., Ltd. established in 2011. Dituto is the manufacturer of Scent diffusers, ultrasonic aroma diffusers, humidifier, NM Facemaster and air purifiers.

It locates in Baoan District, and Dongguan Chang an. Dituto possesses measurable working area over 16000 sqm, and owns 200 staffs. Our capacity is 300000 pieces every month. Products sales to China 25 provinces and exported to the Middle East, South East Asia, Australia, USA, Canada, Japan and the EU.

**主要展品 /Products**

香薰机, 扩香仪, 加湿器, 空气净化器, 真空泵, 真空保鲜盒, 冷风扇;  
Essential Oil Diffuser, aroma diffuser, nebulizer, air humidifier, vacuum pump, air cooler, air purifier;

**深圳市点缀文化科技有限公司****E3-3A48**

地址: 深圳市宝安区西乡街道劳动社区西乡大道 288 号华丰总部经济大厦 A 座 318-321  
电话 /Tel: 18676396572

深圳市点缀文化科技有限公司成立于 2018 年, 坐落于深圳, 是一家专注于美容仪器、个护类产品、创意家电设计研发及生产型企业。

**主要展品 /Products**

微孔水光仪、可视化黑头仪、可视粉刺针、可视化耳勺、颈纹仪、冲耳器等

**鼎昇电器****深圳市鼎昇电器有限公司****N3-3B56****Shenzhen Dingsheng Electric Appliance Co., LTD.**

地址: 广东省深圳市宝安区沙井街道沙三东风工业区  
Add: Shasan Dongfeng Industrial Zone, Shajing Street, Bao'an District, Shenzhen, Guangdong  
电话 /Tel: 0755-2993505  
网址 /Web: www.dapaicn.com

鼎昇电器是全球最专业的真空系列家用小家电研发基地及生产厂家之一, 是一个集技术专利、市场调研、工业设计、半成品加工、产品装配、产品认证、自主品牌以及售后服务为一体的现代化集团, 目前产品线已覆盖真空保鲜机、真空保鲜罐、真空保鲜袋、真空红酒塞等四大系列。

DINGSHENG Electric Appliance is the one of the most professional R&D base and manufacturers of household vacuum seal series product, and is a modern group integrating technical patents, market research, industrial design, semi-finished product processing, product assembly, product certification, independent brand and after-sales service. At present, the product line has covered four series: vacuum sealer machine, vacuum sealer jar, vacuum sealer bag, and red wine vacuum stopper.

**主要展品 /Products**

真空保鲜机、真空保鲜罐、真空保鲜袋、真空红酒塞等四大系列  
vacuum sealer machine, vacuum sealer jar, vacuum sealer bag, and red wine vacuum stopper.

**深圳市鼎信商贸有限公司  
Shenzhen Dingxin Trading Co., Ltd****E2-2F01**

地址: 深圳市龙华新区观澜环观南路金雄达科技园 C 栋 3 层 (518000)  
Add: 3F, Building C, Jinxiongd Industrial Park, Huanguan South Road, Guanlan, Longhua District, Shenzhen, China  
电话 /Tel: 0755-23604862  
传真 /Fax: 0755-23604862  
网址 /Web: www.hizero.cn & www.laurastar.cn

【HIZERO】2013 年创立的技术创新品牌, 推出由仿生灵感研发的仿生洗地机, 具有“UltimateClean 仿生黏附清洁技术”, 彻底打破了传统真空吸尘时代的局限, 一步即可完成清洁步骤。【LAURASTAR】1980 年在瑞士创立, 专注于熨烫技术的研发与创新, 是衣物熨烫护理系统的开拓者, 更享有“百年瑞士八大发明之一”的美誉, 独创 DMS 蒸汽可以杀菌消毒, 深层净化衣物。

【HIZERO】HIZERO is a technology innovation brand. After 10 years of R&D and innovation, an bionic floor cleaner developed by bionic inspiration launches, with "UltimateClean bionic adhesion cleaning technology", which completely breaks the limitation of vacuum cleaning era, and complete deep cleans the floor in one step. 【LAURASTAR】Laurastar, the Swiss brand, is the world leader in professional ironing systems for home use, sold in more than 50 countries around the world. With 40 years of innovation and care, it serves the highest standards of quality for textiles. In Switzerland, nearly a quarter of the households are equipped with a Laurastar. Since its creation, Laurastar has, through its products, continuously reflected the demand for quality, precision and aesthetics that has made Swiss skill a world standard. The excellence you need, to enhance both your clothes and your daily life.

**主要展品 /Products**

【HIZERO】Hizero 多合一仿生洗地机 F580, F100  
【LAURASTAR】Smart 智能熨烫系统系列: Smart u, Smart i, Lift 3 合 1 便携式熨烫机系列: Lift xtra, Lift plus, Lift, IZZI PLUS 净化蒸汽挂烫机

[HIZERO]Hizero All-In-One Bionic Hard Floor Cleaner F580, F100  
[LAURASTAR]SMART series:ALL-IN-ONE Ironing System;LIFT series:3-IN-1 Steam Generators; IZZI PLUS:Hygienic Steamer

**深圳市发掘科技有限公司  
Discovery Technology(SHENZHEN) Co.LTD****W3-3A33 3A34**

地址: 深圳市宝安区西乡街道固戍航城大道骏翔 U8 智造产业园 U6 栋七楼 (518100)  
Add: 7 floor, Building U6, Jun Xiang U8 Industrial Park, Gushu Hangcheng Avenue, Xixiang Street, Bao'an District, Shenzhen  
电话 /Tel: 0755-26977651  
网址 /Web: www.vdiscovery.cn

深圳市发掘科技有限公司于 2007 年 7 月成立, 是一家物联网高新技术企业。发掘科技致力于物联网创新生态与产品构建, 在智能家与生活、汽车与工业物联网、平台与运营、国际物联生态四大版块

进行战略布局,形成以智慧家庭、智慧交通(V2X)为主产品线,以智慧政务(GIS)、两轮车生态、国际物联网消费为附产品线的“2+3”业务模式,与客户展开集研发、生产、销售、服务、生态于一体的物联网细分化场景运营合作。

Shenzhen Discovery Technology Co., Ltd. was established in July 2007 and is a high-tech enterprise in the Internet of Things. Adhering to the core development concept of technology-driven market, Discovery Technology is committed to IoT innovation ecology and product construction, engaged in the development and promotion of IoT artificial intelligence hardware, software, and platform. Based on the characteristics of the Internet of Things and its own common capabilities, in the smart home and life, Automotive and Industrial Internet of Things, Platforms and Operations, and International IOT Ecosystem. The four major sections of the IOT Consumption is a "2+3" business model with a product line, and it cooperates with customers in subdivided IoT scenarios that integrate R&D, production, sales, service, and ecology.

#### 主要展品 /Products

家电智能控制模块及软件系统:提供厨电智能化产品核心高中低端模组化产品、提供全屋家电软硬件以及平台体系化建设能力;支持客户基于模块的二次开发,以及深度定制业务,生成智能料理机、智能烤箱、智能冰箱、智能抽油烟机、智能电饭煲、智能微波炉、智能咖啡机、智能烤箱、智能洗地机等家电产品。

Intelligent control module and software system of household appliances: provide the core high, middle and low-end modular products of kitchen electric intelligent products, provide the software and hardware of household appliances and the systematic construction ability of the platform; Support customers' module based secondary development and in-depth customization business, and generate household appliances such as intelligent cooking machine, intelligent steaming oven, intelligent refrigerator, intelligent range hood, intelligent rice cooker, intelligent microwave oven, intelligent coffee machine, intelligent oven and intelligent floor washer.

## STYLE

### 深圳市范儿科技有限公司

E3-3A14 3A15

地址:深圳市宝安区西乡航城街道华丰第二工业园瑜盛楼6楼

电话 /Tel: 18823818409

深圳市范儿科技有限公司是一家集自主研发、设计及生产、运营于一体的新型企业。公司成立于2012年,多年来一直从事于新型按摩器行业,经过不断努力和不断创新,系列产品均获得多项外观及实用新型专利证书。2018年范儿科技被评选为中国影响力企业、并通过ISO9001中国质量管理体系认证。现公司有员工两百余人,厂房面积达8000平米,产品月产能40万台以上。

#### 主要展品 /Products

眼部按摩器、颈部按摩器、头部按摩器等



### 深圳市方之界科技有限公司

E2-2A03

#### SHENZHEN FANGZHIIJE TECHNOLOGY CO.,LTD

地址:深圳市光明新区白花洞第一工业区安晟创园C栋5楼

电话 /Tel: 0755-2740 7476

网址 /Web: https://shop166w821c475w4.1688.com

深圳市方之界科技有限公司是一家拥有自主知识产权核心技术的高新技术企业,坚持创建以“方之界专业无线便携移动小家电国际化品牌”为企业目标和理想,致力于以自主原创设计-研发-生产-销售于一体的高科技企业。历经多年的快速发展,如今的方之界已发展成为拥有自主的线路板方案开发公司-自主开模注塑公司-原创ID设计公司的高技术企业。

Shenzhen Fangzhijie Technology Co., Ltd. is a high-tech enterprise with core technology of independent intellectual property rights. Adhere to the "professional wireless that is committed to independent original design, R & D, production and sales." After years of rapid development, Today, Fangzhijie has developed into a high-tech enterprise with its own circuit board solution development company, independent injection molding company, original ID design company.

#### 主要展品 /Products

研磨机,榨汁杯,加热恒温杯,打蛋器,料理棒,绞肉机

Coffee grinder, Juice cup, Heating thermostatic cup, whisk, Cooking stick, mincer



### 深圳市飞猫电器有限公司

E3-3C76

#### Fly cat Electrical Co., Ltd.

地址:中国广东省深圳市宝安区福永街道白石厦社区龙王庙工业区28栋、30栋(518104)

Add: No. 28&30 Bldg., Longwangmiao Industrial Park, Baishixia Community, Fuyong Street, Bao'an District, Shenzhen, China 518104

电话 /Tel: 0755-27298495

传真 /Fax: 0755-27298495

网址 /Web: www.fly-cat.com.cn

深圳市飞猫电器有限公司旗下口腔个人护理品牌-Nicefeel耐菲尔,耐菲尔品牌立足于人类健康事业,专注个人护理研究,以先进技术和科研成果研制出具备专业级冲牙器,并整合与世界牙科领域同步的优质服务,让更多患有口腔疾病的人士获得高端品质的口腔专业护理。目前,耐菲尔已获得6项外观设计专利证书、3项实用新型专利证书、4项软件著作权证书,并取得国家医疗器械注册(13485医疗器械认证)。

Fly Cat was established in 2012, located in the scenic Bao'an district of Shenzhen, near Shenzhen International Airport. Fly Cat are the professional manufacturer of personal dental care / oral care products, there are 2 series of production line, family oral irrigator and portable oral irrigator. Our company has passed ISO 13485:2016 quality management system certification, also obtained a medical device registration certification. Our professional factory can stand up to your professional test.

#### 主要展品 /Products

洗牙器、洗鼻器

Water flosser, nasal irrigator

**PROTMEX®****深圳市菲比斯科技有限公司****W3-3H94****PROTECH INTERNATIONAL GROUP CO., LI**

地址: 深圳市南山区西丽街道大磡社区大磡工业二路 9 号 A501

Add: A501, No. 9, Dakan Industrial Second Road, Dagang Community, Xili Street, Nanshan District, Shenzhen

电话 /Tel: 18688930815

网址 /Web: www.protech-instruments.com

深圳市菲比斯科技有限公司创立于 2016 年, 是一家专注环境、健康检测的创新型企业。主要经营甲醛, 二氧化碳、温湿度、辐射仪等民用检测仪的研发、生产、销售。目前我司获得“国家高新技术企业”证书, 自主研发产品也申请了相关专利和认证。另外, 我们有独立的生产工厂, 可支持 OEM 和 ODM 等合作形式, 已经为广大外贸和内销卖家提供不计其数的优质产品, 公司远销世界各地, 深受当地消费者的好评。

Protech International Group Co., Ltd. was founded in 2009 and has been committed to the development and manufacturing of smart home products.

At present, our company has obtained the certificate of "National High-tech Enterprise", and the self-developed products have also applied for related patents and certifications. In addition, we have an independent production factory, which can support OEM and ODM cooperation forms, and has provided countless high-quality products for the majority of foreign trade and domestic sellers. The company's products are sold all over the world and are well received by local consumers.

**主要展品 /Products**

甲醛检测仪、二氧化碳检测仪、一氧化碳检测仪、综合空气监测仪、智能空气监测仪

温湿度计、温湿度时钟、智能温湿度计

气象时钟

酒精检测仪

非接触测电笔

核辐射监测仪

便携式 UV 消毒灯

Formaldehyde detector, Carbon dioxide detector, Carbon monoxide detector, Comprehensive air monitor, Intelligent air monitor

Temperature and humidity meter

Meteorological clock

Alcohol detector

Non-contact stylus

Nuclear radiation monitor

Portable UV disinfection lamp

**GoT.e****深圳市构通科技有限公司****W1-1B26****Gotong technology**

地址: 深圳市龙华区民治街道白石龙社区新区大道新龙大厦 610 (518000)

Add: 610, Xinlong Building, New Avenue, Baishilong Community, Minzhi Street, Longhua District, Shenzhen

电话 /Tel: 0755-83388159

传真 /Fax: 0755-83388159

网址 /Web: www.szgote.com

GoTe 致力于推出系列智能化模块及系统级产品解决方案。为客户提供完整的供应链, 保证客户系统产品开发达到深具行业水准的市场化产品。体现、创造、赢得价值!

GoTe is committed to introducing a series of intelligent modules and system level product solutions. Provide customers with a complete supply chain. Ensure customer system product development to achieve deep industry level market products. Embody, create, win value!

**主要展品 /Products**

GOT2065 系列是智能注液检测模块以先进的红外光学传感器技术为基础配合智能算法可以自动监测水杯高度, 液位变化来实现全自动出水 and 停水; 同时可以识别不规则杯型或异物 (手, 手机, 玩具等异物...) 有效防止误出水, 误触发等等

GOT2065 series is an intelligent liquid injection detection module based on advanced infrared optical sensor technology and intelligent algorithm can automatically monitor the height of the water cup, liquid level changes to achieve automatic water outlet and water shutdown; At the same time can recognize irregular cup shape or foreign body (hand, mobile phone, toys and other foreign body...) Effectively prevent the wrong water, wrong trigger and so on

**深圳市航天电机系统有限公司****E1-1A33 1A34****Shenzhen Casic Motor System Co., Ltd.**

地址: 深圳市光明区马田街道石家社区经济发展总公司第五工业区 A 区第 1 栋 101 (518106)

Add: Building A, No. 51, Nanhuan Avenue, Gongming Street, Guangming District, Shenzhen City, China

电话 /Tel: 0755-27179907

传真 /Fax: 0755-86321499

网址 /Web: www.casicmotor.com

公司为国资委管辖的全资央企, 隶属于中国航天科工集团公司, 拥有国家微特电机工程技术研究中心和微特电机检测中心等平台支持。

运行有效的 ISO9001 质量管理体系, 拥有完整、独立的电机及传动研发队伍和检测、分析能力, 依托国家工程技术中心和检测中心的设计、仿真、检测和分析能力, 公司在无刷直流电机、精密齿轮传动、阀、泵等产品的研制、生产、检测、质量管理、供应链资源方面积累了一定的特色、优势和能力。

A subsidiary of China Aerospace Science and Industry Corporation (a state-owned enterprise, No. 332 in the 2020 Fortune500); Shenzhen Casic Motor System Co., Ltd. was established





in 1985, adhering to the aerospace science and technology innovation spirit, relying on the professional technical support of the parent company, it has been developed into a high-tech motor manufacturer with strong technical research and development capabilities, production capabilities and quality control capabilities. The parent company Linquan Aerospace Motor Co., Ltd. was established in 1965. It is a well-known aerospace high-tech motor manufacturer in China and a supporting enterprise of China's National Precision Micro Motor Engineering Technology Research Center.

#### 主要展品 / Products

直流无刷电机、直流无刷减速电机、直流减速电机、泵类等  
DC Brushless Motor, DC Brushless Gear Motor, Pump.



#### 深圳市好运达电器有限公司

W5-5A27

#### Shenzhen Luckystar Electrical CO., LTD.

地址：深圳市宝安区沙井街道衙边社区后亭地铁站D出口同方创意文化产业园1栋203

电话 / Tel: 0769-83638968

网址 / Web: <https://luckystar-steam.com>

深圳市好运达电器有限公司是一家集研发生产销售为一体的全球性小家电企业。通过长年努力，积累了丰富的产品开发设计生产经验，培养了一支勇于创新 and 精益求精的设计生产品质管理团队，公司主要产品为蒸汽熨烫机及家用杀菌类等系列产品先后通过 3C CQC CB CE GS 等认证，工厂严格按照 IOS9001 — 2015 国际质量管理体系管理运作。产品远销欧美、东南亚地区的 80 多个国家，企业品牌知名度和产品销量行业领先！

#### 主要展品 / Products

蒸汽熨烫机



Black White Grey

#### 深圳市黑白灰通信技术有限公司

N2-2A57

#### Shenzhen Black White Grey Communication Technology Co., Ltd.

地址：深圳市福田区车公庙泰然工业园 301 栋东座 4 楼

电话 / Tel: 15813848914

从智能科技产业出发，到逐渐扎根创新小家电技术行业，从研发、设计、生产、销售到售后服务，我们牢牢把控整个产业链，并且拥有自己专业的研发中心、独立工厂、印度及迪拜海外技术、销售服务中心，坚持从项目立项到售后服务的全程一条龙模式，完美平衡品质与成本。

#### 主要展品 / Products

家用智能感应式皂液机、智能感应牙刷消毒盒、智能家用抽水器、大容量呼吸灯空气加湿器、负离子出风机、驱蚊器和香氛机



#### 深圳市鸿港电子有限公司

E1-1A10

#### SHENZHEN HONK ELECTRONIC CO., LTD

地址：深圳市宝安区航城街道鹤洲社区金佛工业区辉胜达厂房 8 栋 3 楼 (518128)

Add: 3F, Building 8, Jinfo Industrial Area, He Zhou Community, Hangcheng Street, BaoAn District, Shenzhen City, China

电话 / Tel: 13632947051

传真 / Fax: 0755-27325030

网址 / Web: [www.honktech.com](http://www.honktech.com)

深圳市鸿港电子有限公司成立于 2000 年，公司坐落于美丽的广东省深圳市，占地面积 5000 多平方公里，致力于车载吸尘器、家用吸尘器、迷你风扇、usb 小音箱等电子产品的研发、设计、生产及销售，工厂通过 SEDEX 验厂，产品通过 CE/ISO/ROHS/REACH/FCC 等认证，并拥有自己的外观设计专利，我们已经与世界各地的客户建立了友好长久的合作关系，像日本、韩国、美国、英国、新加坡等等。欢迎莅临公司参观拜访。

Established in 2000, Shenzhen Honk Electronic Co., Ltd is dedicated to the development, design and production of the USB fans, mini vacuum cleaners, usb mini speakers, etc. The factory covers an area of over 3000 square meters, The factory has passed sedex inspection and got the sedex report. All products have been passed by CE, ISO, REACH, ROHS, etc. We have built long-term friendly relationship with customers from Japan, Korea, USA, UK, Singapore, Sweden, Germany and many other countries. Welcome to come to visit.

#### 主要展品 / Products

车载吸尘器、家用吸尘器、迷你风扇、电脑小音箱等电子产品

Electric products, like car vacuum cleaner, household vacuum cleaner, mini fan, usb mini speaker, etc



HONGHAOSHENG

#### 深圳市鸿昊升电子有限公司

E3-3A46

#### Shenzhen Honghaosheng Electronics Co., Ltd.

地址：广东省深圳市龙华区观澜街道人民路 666 号金通盛大厦 7 楼 (518110)

Add: 701E, No.666 East-Renmin Road, Guancheng Community, Guanlan Street, Longhua District, Shenzhen

电话 / Tel: 0755-28237685

传真 / Fax: 0755-28016834

网址 / Web: [www.sz-battery.com](http://www.sz-battery.com)

集研发，设计，生产和 Pack 一体的综合性锂电池生产厂家，行业经验 18 年！

Lithium battery manufacturer since 2004!

#### 主要展品 / Products

锂聚合物电池，锂电池组，磷酸铁锂储能电池

Lithium polymer battery, li ion battery pack, LiFePo4 battery



华鼎元

深圳市华鼎元电子科技有限公司

HDY ELECTRONIC TECHNOLOGY Co., Ltd.

E3-3B05

地址: 深圳市宝安区福永街道福永社区福海科技工业园 A1 栋 4 楼 (518103)

Add: Fuhai Science and Technology Industrial Park, Fuyong Community, Fuyong Street, Bao 'an

电话 /Tel: 0755-29466651

传真 /Fax: 0755-29357647

网址 /Web: www.hdybattery.com

深圳市华鼎元电子科技有限公司, 是一家集锂离子电池研发, 生产 销售服务于一体的高新技术企业, 公司产品主要应用于各种智能穿戴、智能家居、智能机器人、电动智能吸尘器、智能扫地机、按摩产品、等小家电领域, 公司为做好品质建立了全员参与、全员控制, 持续改进的质量管理体系, 诚信赢取客户满意的质量方针, 严抓 加工 生产 等每个细节, 我们将以优质的品质及服务满足您的需求, 为锻造中国新能源的产业丰碑而永远向前!

Shenzhen hua ding yuan electronic technology co., LTD., is a collection of lithium ion battery research and development, production sales and service in the integration of high-tech enterprises, the company products are mainly applied to all kinds of intelligent apparel, smart home, intelligent robot, electric intelligent cleaner, intelligent sweeping machine, electric tools, massage products, such as small home appliance field, Towards the peak of the new type of green energy to reach, the company set up a full participation, full control, continuous improvement of the quality management system, good faith to win customer satisfaction of the quality policy, strict on form a complete set of processing production, etc Every detail, we will with excellent quality and service to meet your needs, for forging China's new energy industry monument forward forever!

#### 主要展品 /Products

聚合物锂电池 聚合物电池组 圆柱锂电池 圆柱电池组等

Polymer lithium battery Polymer battery cylindrical lithium battery cylindrical battery, etc.



深圳市欢创科技有限公司

深圳市欢创科技有限公司

Shenzhen Camsense Technology Co., Ltd.

W4-4B39

地址: 深圳市龙华区民治街道鸿荣源北站商业中心 C 座 18 楼 (518000)

Add: 18F, Block C, Honroy North Center, Minzhi Street, Longhua District, Shenzhen

电话 /Tel: 075586704661

传真 /Fax: 0755-86704661

网址 /Web: www.camsense.cn/

Camsense【深圳市欢创科技有限公司】创办于 2014 年。自成立以来, 一直致力于高精度定位视觉传感器的研发, 旨在为各类人工智能应用提供核心技术与产品支持。至今, Camsense 已拥有完全自主知识产权的核心算法以及芯片 (130+ 项专利申请, 已获 60+ 项授权), 是国内首家拥有单目大空间亚毫米级定位精度能力的企业, 全球首家自研空间定位算法芯片的企业。

Camsense (Shenzhen Camsense Technology Co., Ltd.) was founded in 2014. Since then, it has been dedicated to the development of high-precision positioning vision sensors. The company specializes in providing core technology and product supports for artificial intelligence application of all kinds.

As the first domestic enterprise with submillimeter positioning precision for monocular large space sensors, Camsense also represents the world's first company which develops, by its own, its algorithm chip in spatial positioning. The company has, up to now, obtained core algorithms and chips with completely independent intellectual property rights (130+ patent applications and 60+ authorizations).

#### 主要展品 /Products

激光雷达、VR 手柄、高精度定位系统

LiDAR, VR controller, High precision positioning system



深圳市汇奇美科技有限公司

Shenzhen Huiqimei Technology Co., Ltd

E1-1F61

地址: 深圳市龙岗区龙平西路志达工业园 A 区 3-4 楼 (518172)

Add: 3-4/f, Factory Area A, Zhida Industrial Park, Longgang District, Sz

电话 /Tel: 0755-89362883

传真 /Fax: 0755-89362883

网址 /Web: www.huiqimei.com

汇奇美致力于创意消费电子产品的研发、生产与销售。现研发团队 12 人, 发明专利 2 个, 外观专利 56 个, 实用专利 22 个。公司提供 OEM、ODM 服务, 产品热销于国内、日韩、东南亚、欧美等国家和地区。我们严把质量关, 贯彻 ISO9001 质量管理体系, 产品均通过常规认证, 符合国家标准, 符合出口标准。公司坚持“品质至上, 创新为主, 快乐感恩, 诚信共赢”的服务理念, 成为各大品牌公司、渠道及外贸公司的金牌供应商。

Huiqimei is committed to the R&D, production and sales of creative consumer electronics products. There are currently 12 R&D staffs, 2 invention patents, 56 appearance patents, and 22 utility patents. The company provides OEM and ODM services, and the products are sold well in countries and regions including China, Japan, South Korea, Southeast Asia, Europe and the United States. We strictly control the quality, implement the ISO9001 quality management system, and our products have passed the regular certification, in line with national standards, and in line with export standards. The company adheres to the service concept of "quality first, innovation-oriented, happy and grateful, honesty and win-win", and has become a gold supplier of major brand companies, channels and foreign trade companies.

#### 主要展品 /Products

迷你手持风扇、桌面制冷风扇、挂脖冷暖仪、智能空气净化器、车载香薰加湿器、加湿暖风机、美容补水按摩仪、暖手宝、香薰机

Mini handheld fan, desktop cooling fan, hanging neck heating and cooling device, smart air purifier, car aromatherapy humidifier, humidification heater, beauty moisturizing massager, hand warmer, aromatherapy machine



HUONI

**深圳市火牛科技有限公司****SHENZHEN HUONIU TECHNOLOGY CO.,LTD****E1-1A23 1A24**

地址: 深圳市光明新区公明街道西田第四工业区第五栋 (518107)

Add: Gongming Town, Guangming District, Shenzhen, Guangdong, p.r.China

电话 /Tel: 0755-29828033

传真 /Fax: 0755-28079166

网址 /Web: www.szuoni.cn

深圳市火牛科技有限公司创立于 2004 年, 现有员工人数 450 人, 是一家专业研发、生产、销售各类开关电源、电源适配器、医疗电源、通信电源、充电器、工业电源、特种电源以及定制电源的著名品牌高新企业。

公司产品取得了 CB、UL(CUL)、CSA、FCC、TUV/GS、PSE、CE、CCC/CQC、SAA、KC、ERP、MEPS 等多国家多标准的产品认证, 产品畅销国内及欧、美、日、韩、澳等市场。

Shenzhen huoni Technology Co., Ltd. was founded in 2004 with 450 employees. It is a famous brand high-tech enterprise specializing in R & D, production and sales of all kinds of switching power supply, power adapter, medical power supply, communication power supply, charger, industrial power supply, special power supply and customized power supply.

The company's products have obtained the product certification of CB, UL (cul), CSA, FCC, TUV / GS, PSE, CE, CCC / CQC, SAA, KC, ERP, MEPS and other countries and standards. The products sell well in domestic and European, American, Japanese, Korean, Australian and other markets.

**主要展品 /Products**

5W-90W 开关电源适配器, 取得 CQC/CCC、UL1310、CE61558、PSE 等国家认证

5w-90w switching power adapter has obtained CQC / CCC, UL1310, ce61558, PSE and other national certifications

**深圳市吉奥科技有限公司****SHENZHEN GEO TECHNOLOGY CO.,LTD****E3-3A30**

地址: 深圳市光明新区光明街道华强创意产业园 4A13 楼 (518106)

Add: 13 Building 4-A, Huaqiang Creative Industrial Park, Guangming Sub-District, Shenzhen

电话 /Tel: 0755-23220693

传真 /Fax: 0755-23221190

网址 /Web: www.szjiao.com

深圳市吉奥科技有限公司成立于 2006 年 5 月, 是一家生产销售电源适配器、充电器的民营企业, 公司目前员工 500 人, 6 条组装生产线, 拥有注塑、AI 插件、SMT 等先进的自动化生产设备, 产品通过了相关国家的安规认证, 欢迎客户朋友参观考察!

Shenzhen Gonow Technology Co., Ltd. was established in May 2006. It is a private enterprise that produces and sells power adapters and chargers. The company currently has 500 employees, 6 assembly lines, and has advanced automated production such as injection molding, AI plug-in, SMT, etc. The equipment and products have passed the safety certification of relevant countries.

Welcome customers and friends to visit!

**主要展品 /Products**

主要生产销售电源适配器、充电器、开关电源, 功率从 5W 到 450W, 相关国家的安规认证齐全

Mainly produce and sell power adapters, chargers, switching power supplies, with power from 5W to 450W, and complete safety certifications in relevant countries

**深圳市集创兴科技有限公司****Shenzhen TCS Precision Technology Co., Ltd****W3-3H91**

地址: 广东省深圳市龙华区民治街道民康路东明大厦 1123 (518001)

Add: 1123 Dongming Building, Minkang Road, Minzhi Street, Longhua District, Shenzhen, China

电话 /Tel: 0762-3388256

传真 /Fax: 0755-28052870

网址 /Web: www.tcstec.com

深圳市集创兴科技有限公司创立于 1996 年, 公司位于深圳, 生产基地位于广东河源市。工厂占地 26000 平方米, 建筑面积 45000 平方米, 员工 600 余人, 拥有高效的研发团队和先进的生产自动化设备; 研发设计能力, 获得了 ISO9001、ISO14001、TS16949 体系认证。公司主要研发和生产微电机、微气泵、水泵、电磁阀、水阀、电磁铁、精密减速箱、精密减速电机等。

Shenzhen TCS Precision Technology Co., Ltd. was founded in 1996, the company is located in Shenzhen, the production base is located in Heyuan City. The company covers an area of 26,000 square meters, construction area of 45,000 square meters, more than 600 employees, has an efficient R & D team and advanced production automation equipment; R&d, design, production and sales set in one intelligent one-stop service high-tech enterprises. The company mainly develops and produces micromotors, micro-air pumps, water pumps, water and air mixed pumps, solenoid valves, water valves, water, electromagnets, precision reduction boxes, precision reduction motors and high precision parts. Products are widely used in medical instruments, household appliances, beauty and health care, air purification, smart home, automobile parts, environmental protection parts, sweeper, water applications, robots, drones and modern intelligent fields. Products based on domestic and foreign markets.

**主要展品 /Products**

微电机、微气泵、水泵、水气混合泵、电磁阀、水阀、水气混合阀、电磁铁、精密减速箱、精密减速电机。

产品广泛用于医疗器械、家用电器、美容保健、空气净化、智能家居、汽车部件、环保部品、扫地机、水应用、机器人、无人机及现代智能领域。

Micro motor, micro air pump, micro water pump, water and air mixing pump, solenoid valve, water valve, water and air mixing valve, electromagnet, precision reduction box, precision reduction motor, gear motor and so on.

## yoose

深圳市加减生活科技有限公司

Shenzhen XIVOLIFE Trading Co., Ltd.

地址: 深圳市南山区南头街道安乐社区关口二路 15 号智恒产业园 7 栋 (518000)

Add: Building 7, Zhiheng Industrial Park, Nanshan District, Shenzhen, Guangdong

Province, China

电话 /Tel: 4001178080

传真 /Fax: 075582508679

网址 /Web: www.yoosetrendy.com

E3-3F01

yoose/ 有色品牌成立于 2019 年, 是由中国顶级工业设计公司—佳简几何首推的独立原创品牌, 曾服务过微软、腾讯、阿里巴巴、百度等知名品牌, 现团队共获 Reddot/IF/IDEA/Good Design 等国际设计大奖 100 余项, 是中国工业设计历史上成立时间最短、获得国际设计大奖最多的工业设计公司。yoose/ 有色秉承“极致即个性, 经典即潮流”立志打造代表中国年轻一代生活态度的设计品牌。

This Fashionable Brand of Urban Personal Care Design is built by XIVO DESIGN, the top Chinese industrial design team. We aim to create a boutique with a distinctive personality and a timeless style, rejecting homogenization and persevering with the use of unique design and high-grade materials, so as to become “the most popular choice” for the younger generation of Chinese consumers who pursuit quality life.

## 主要展品 /Products

yoose 设计了市面上第一款全合金机身、掌心大小的电动剃须刀, 采用金属材料、运用了电镀与汽车烤漆工艺来打破了市面上大部分剃须刀的固有状态。7200 转 /min 静音高速电机, 1 小时快充, 可用 30 天, IPX-7 级防水, 不惧全身水洗挑战, 长按开关旅行锁功能, 避免误触。内部元器件采用的高集成度的结构设计使得元器件与机身接触缝隙小于 0.5 毫米, 整体机身仅有蓝牙耳机大小, 将内部空间运用到极致。

yoose designed the first all-alloy body, palm-sized electric shaver on the market. It uses metal materials, electroplating and car paint processes to break the inherent state of most shavers on the market. 7200 rpm silent high-speed motor, 1 hour fast charge, 30 days available, IPX-7 waterproof, no fear of body washing challenges, long press the switch travel lock function to avoid accidental touch. The highly integrated structural design of the internal components makes the contact gap between the components and the fuselage less than 0.5 mm, and the overall fuselage is only the size of a Bluetooth headset, which maximizes the internal space.

深圳市佳简几何工业设计有限公司

Shenzhen XIVO Design Co., Ltd.

地址: 广东省深圳市南山区智恒产业园 7 栋 (518000)

电话 /Tel: 0755-86565152

传真 /Fax: 0755-86565152

网址 /Web: www.xivodesign.com

W4-4F71

佳简几何 (XIVO DESIGN) 成立于 2014 年, 以品牌定位与全案设计为核心, 提供涵盖产品设计、品牌设计、包装设计、视觉设计四大创新服务模块。以成为代表中国的国际化创新设计团队为愿景, 用中国设计打造世界品牌。被评为国家高新技术企业、省级工业设计中心, 五次获评深圳市十佳工业设

计公司并蝉联四年深圳十佳工业设计公司榜首, 荣获两百余项国内外知名设计大奖, 成为业内最具知名度和创新力的设计团队。

XIVO DESIGN was established in 2014, with brand positioning and full project design as the core, providing four innovative service modules covering product design, brand design, packaging design and visual design. With the vision of becoming an international innovative design team representing China, we use Chinese design to build a world brand. We have been awarded as a national high-tech enterprise and a provincial industrial design center, and we have been awarded as one of the top ten industrial design companies in Shenzhen for five times and topped the list of top ten industrial design companies in Shenzhen for four years, and won more than two hundred famous design awards at home and abroad, making us the most well-known and innovative design team in the industry.

## 主要展品 /Products

服务客户: 涵盖智能科技、生活家电、美妆个护、食品饮料智能穿戴等众多领域, 拥有上千名合作伙伴。包括腾讯、阿里巴巴、B 站、小米、OPPO、字节跳动、联想、携程、海底捞、今麦郎、立白、Amiro、蓝系、猫王、超级猩猩、usmile、素士、Ulike、YOOZ、悦刻等。打造了许多现象级品牌和产品, 帮助企业从 0-1 孵化全新品牌全案; 实现从 1 到 10 的快速成长, 助力品牌获得更高的市场价值和收益。

Service customers: covering smart technology, life appliances, beauty and personal care, food and beverage smart wear and many other fields, with thousands of partners. Including Tencent, Alibaba, B station, Xiaomi, OPPO, Byte Jump, Lenovo, Ctrip, Haidilao, Imelda, Lipai, Amiro, Blue Series, Elvis, Super Ape, usmile, Sush, Ulike, YOOZ, Yuecheng, etc.. We have created many phenomenal brands and products, helping companies to incubate new brand full projects from 0-1; achieving rapid growth from 1 to 10, and helping brands to gain higher market value and revenue.

深圳市甲由设计顾问机构有限公司  
Jaudesign Agency

W5-5C67 5C68

地址: 深圳市宝安区中粮 031 创意园 C 栋第一层 C111-112 号 (518000)

Add: C111, Zhongliang 031 Creative Park Bao'an District Shenzhen China (86)

电话 /Tel: 13066964943

传真 /Fax: 13066964943

网址 /Web: www.jaudesign.com

甲由设计 19 年致力于推动中国工业设计的进步和发展, 以最具创新专业的设计成就更多中国民族企业成为全球行业顶尖品牌。过往负责的项目多次荣获德国 if 奖、台湾金点奖、红点奖, 金芦苇工业设计奖等国内外知名奖项。

目前服务的客户有: 华为、中兴、百度、腾讯、公牛、科大讯飞等国内外知名企业。公司主要的业务范围是工业设计和品牌设计。

The design is committed to promoting the progress and development of China's industrial design, with the most innovative professional design achievement, more Chinese national enterprises have become the top brand of the world. The past, responsible projects have won the German IF Award, Taiwan Gold

## 主要展品 /Products

品牌设计、工业设计、商业营销、交互界面设计

Brand design, industrial design, commercial marketing, interactive interface design



## FASCINATE

斐色耐

深圳市建源达镜业科技有限公司  
ShenZhen JianYuanDa Mirror Technology Co., Ltd

E3-3C71

地址: 深圳市宝安区新安街道海滨社区 N23 区海天路 15-3 号卓越宝中时代广场  
二期 C 栋 1501 (518000)

Add: Building 37, District 5, Cuigang Industrial Zone, Huaide, Fuyong Street, Bao'an  
District, Shenzhen

电话 /Tel: 13823535134

传真 /Fax: 0755-29595121

网址 /Web: <http://www.fascinate-mirror.com/>

深圳市建源达镜业科技有限公司成立于 2008 年, 是一家专注于轻智能 LED 化妆镜、家装镜的研发、制造、生产与销售的综合型企业。公司重视自主研发设计, 产品设计多次获得德国红点设计大奖, 拥有海内外化妆镜外观专利及实用新型专利 100+ 项。截止目前建源达化妆镜已出口全球 40 多个国家和地区。知名合作伙伴如: 欧莱雅、雅思兰黛、西铁城、沃尔玛、COSTOCO, KMART, LIDL 等。

Shenzhen Jianyuanda Mirror Technology Co., Ltd. was established in 2008. It is a comprehensive enterprise focusing on the R&D, manufacturing, production and sales of light and smart LED makeup mirrors and home improvement mirrors. The company attaches great importance to independent R&D and design, and its product design has won the German Red Dot Design Award for many times, and has 100+ patents for cosmetic mirror appearance and utility model patents at home and abroad. So far, Jianyuanda Chemical Mirror has been exported to more than 40 countries and regions around the world. Well-known partners such as: L'Oreal, Estee Lauder, Citizen, Wal-Mart, COSTOCO, KMART, LIDL, etc.

## 主要展品 /Products

斐色耐 LED 化妆镜

FASCINATELED Makeup Mirror

GRANDSECU  
——将帅科技——

深圳市将帅科技有限公司  
Shenzhen General Technology Co., Ltd

W4-4A24

地址: 深圳市龙岗区新生社区仙田路 11 号 (518100)

Add: No. 11, Xiantian Road, Xinsheng Community, Longgang District, Shenzhen

电话 /Tel: 0755-28510749

传真 /Fax: 0755-28510749

网址 /Web: [www.grandsecu.cn](http://www.grandsecu.cn)

深圳市将帅科技有限公司是一家从事安防监控、智能家居系列产品的研发、生产、销售的高新技术企业, 我们有完整的研、产、销供应链, 能够从源头上控制产品的成本和质量, 为销售部门提供核心竞争优势。主要产品包括: 智能家居类、低功耗类电池摄像机系列产品等, 产品关键所用的元器件均选自国际知名品牌, 公司先后取得了 ISO9001, FCC, CE 与 RoHS 认证。在未来, 将帅科技将为客户提供更先进的技术 and 更优质的产品服务。

Shenzhen General Technology Co., Ltd. is a high-tech enterprise engaged in the research and

## 参展商名录 (按字母排序) / Alphabetical List of Exhibitors

development, production and sales of security monitoring and smart home products. We have a complete supply chain of research, production and sales, which can control the cost and quality of products from the source. Provide a core competitive advantage to the sales department. The main products include: smart home, low-power battery camera series products, etc. The key components used in the products are selected from internationally renowned brands. The company has successively obtained ISO9001, FCC, CE and RoHS certification. In the future, General Technology will provide customers with more advanced technology and better products and services.

## 主要展品 /Products

我们的产品通过 Wi-Fi 及可充电电池, 实现产品的 100% 无线化; 基于云端计算的 AI 智能算法技术, 能够实现人 / 宠物 / 车辆 / 包裹的识别以及对其活动行为的分析, 并进行有选择性的消息推送; 支持最多针对 3 个关键区域的重点监控; 云端录像存储能够更安全的保存事件录像。

Our products are 100% wireless through Wi-Fi and rechargeable batteries; AI intelligent algorithm technology based on cloud computing can realize the identification of people/pets/vehicles/packages and analyze their activity behavior, and carry out Selective message push; support for key monitoring of up to 3 key areas; cloud video storage can save event video more securely.

Casdon 凯度®

中国蒸烤箱专家

深圳市凯度电器有限公司

N2-2E81

Shenzhen Casdon Electric Appliance Co., LTD.

地址: 深圳市南山区桃源街道平山社区平山一路 2 号南山云谷创业园二期 8 栋 401 (518000)

Add: Building 8, Phase II, Nanshan Yungu Pioneer Park, Taoyuan Street, Nanshan District, Shenzhen

电话 /Tel: 0755-29408899

传真 /Fax: 0755-29408899

网址 /Web: [www.casdon.com.cn](http://www.casdon.com.cn)

凯度电器创立于 2010 年, 是国内首批自主研发蒸烤箱的领先企业, 专注蒸烤箱十一年, 并被评为国家高新技术企业。专于研发与制造以蒸烤领域为核心的蒸烤箱、蒸烤集成灶、蒸烤套装等高端厨电产品, 是迄今为止该领域产品体系最齐全的制造商之一。

致力于传承与创新中国智慧蒸烤文化, 连续十年成为中国最畅销蒸烤箱品牌之一。2021 年被评为中国家用电器协会理事单位, 致力推进行业融合创新, 促进产业升级发展!

## 主要展品 /Products

专于研发与制造以蒸烤领域为核心的蒸烤箱、蒸烤集成灶、蒸烤套装等高端厨电产品。凯度也是目前蒸烤箱行业中, 产品型号最齐全完善的专业品牌之一。拥有嵌入式 T 系 /F 系 /G 系 /Z 系 / 风火轮系列, 台式 8 系 /7 系 /6 系 / 星芒系共九大系列, 以及 20L、26L、28L、40L、42L、56L、60L、80L 八种容量型号, 产品共计 52 款。



**深圳市康弘智能健康科技股份有限公司**  
**HEALTHLEAD COPORATION LIMITED**

**W2-2E51**

地址: 深圳市龙岗区园山街道横坪公路 89 号涌鑫工业厂区 1 号厂房 (518000)

Add: Building1, Yongxin Industry Park, No.89, Hengping Road, Yuanshan Street, Longgang District, Shenzhen

电话 /Tel: 0755-84267250

传真 /Fax: 86-755-84267256

网址 /Web: www.healthlead.com.cn

深圳市康弘智能健康科技股份有限公司 (康弘环保) 是一家专注于空气净化器、净化新风系统及相关环保材料技术研发、生产和销售的高新技术企业。是目前全球最专业的空气净化器生产商之一。专业和创新的产品开发能力使康弘成为全球众多知名品牌 ODM 的供应商, 包括中国、北美、欧洲、日本、韩国等。

Healthlead Corporation Limited "Healthlead" is one leading high tech enterprise which is dedicating in air purifier, air fresh system and related environmental protection material development, manufacturing and marketing, and also major professional air purifier OEM & ODM manufacturer.

**主要展品 /Products**

空气净化器; 空气消毒机; 空气加湿净化器; 除湿机; 消毒类产品

Air Purifier; Air Purifier & Humidifier & Cooler; Mini Dehumidifier; Sterilizer; Pet Appliances



**深圳市科力尔运动控制技术有限公司**  
**Shenzhen Keli Motion Control Technology Ltd.**

**W4-4C81**

地址: 深圳市南山区深圳湾科技生态园 9 栋 B3 座 5 楼 (518057)

Add: 5th Floor, Block B3, Building 9, Shenzhen Bay Science and Technology Ecological Park, Nanshan District, Shenzhen

电话 /Tel: 13112701812

传真 /Fax: 0086 755 81858899

网址 /Web: https://www.kelimotor.com/

科力尔始创于 1992 年, 迄今已成为中国最大的微特电机研发、制造和出口企业之一, 于 2017 年 8 月 17 日挂牌上市, 股票代码 002892。凭借优秀的产品质量, 成为多个世界 500 强企业的重要供应商。应用于智能家电、工业机器人、5G 移动基站、3D 打印机、锂电池、新能源、智能安防等领域, 拥有控制系统、伺服系统、传感系统和高性能电机的先进技术, 打造电机与驱控系统的世界级的中国民族品牌, 为全球用户提供持续的智力!

Established in 1992, Keli motor has become one of the largest micro motor R&D, manufacturers and exporters in the China. With excellent product quality, Keli has become an important supplier to more than one Fortune 500 company. Keli products serve a broad range of industries including intelligent household appliance, industrial robot, 5G mobile base station, 3D Printer, lithium battery, new energy, intelligent security. With the advanced technology of control system, servo system, sensor system and high-performance motor, we will build a world-class Chinese national

brand of motor and drive control system to promote human industrial civilization and progress and provide continuous intelligent power for global users!

**主要展品 /Products**

各种类型的微特电机、交流电机、直流电机、无刷电机、高精度的伺服电机及驱动等等, 产品阵容丰富。广泛应用于 5G 移动基站、工业机器人、智能家电、医疗健康护理、3D 打印、智能安防、暖通设备等领域。

Various types of micro motors, AC motors, DC motors, brushless motors, high-precision servo motors and drives, etc., have a rich product lineup. It should be widely used in 5G mobile base stations, industrial robots, smart home appliances, medical and health care, 3D printing, smart security, HVAC equipment and other fields.



**深圳市莱特兄弟科技有限公司**  
**Shenzhen Wright Brothers Technology Co.,LTD**

**W1-1A15**

地址: 深圳市龙华区观澜街道飞鸽产业园 1223 号 6 栋 5 楼 (518000)

Add: 5th Floor, Building 6, No. 1223, Feige Industrial Park, Guanlan Street, Longhua District, Shenzhen

电话 /Tel: 0755-23053594

传真 /Fax: 0755-23053594

网址 /Web: www.wb-ltk.com

深圳市莱特兄弟科技有限公司坐落于中国最强创新城市之一深圳, 公司成立于 2012 年, 经过多年的潜心经营, 公司在厨房小家电行业构建了完善健康的产业链, 拥有超过 10 年以上生产及管理团队。公司以严谨管理, 卓越品质, 诚信立业为公司经营原则, 立足在小家电行业, 精耕细作。希望我们的努力, 能成为您最可信赖的合作伙伴, 共创辉煌!

Shenzhen Wright Brothers Technology Co., Ltd. is located in Shenzhen, one of the strongest innovative cities in China. Our company was established in 2012. After years of concentrated operation, the company has built a sound and healthy industrial chain in the small kitchen appliance industry, with more than 10 years of production And the management team. The company takes rigorous management, superior quality, and honesty as the company's operating principles, based on the small home appliance industry, and intensively cultivates. I hope that our efforts can become your most reliable partner and create brilliance together!

**主要展品 /Products**

多功能手持料理棒, 婴儿辅食机

Multifunctional handheld stick blender, baby food supplement machine

**LB® 藍寶FUSE****深圳市蓝宝安科电子有限公司**  
**Shenzhen lanbao Anke Electronics Co., Ltd****W4-4A32**地址: 深圳市宝安区西乡航城工业区建源智创园 A1 栋  
电话 /Tel: 0755-27505750  
传真 /Fax: 0755-27505760  
网址 /Web: http://www.lanbaofuse.cn

蓝宝公司是一家研发生产销售电流保险丝、片式精密电流感测电阻、温度开关温度传感器的民营企业, 安规类产品取得 UL, vDE, cCc, cQc, KC, PSE, CB 等相关认证所有产品符合 RoHS 指令和 REACH 法规要求, 公司通过了 ISO9001, IsO14001 体系认证。

Lanbao company is a private enterprise that develops, produces and sells current fuses, chip precision current sensing electric Yang and temperature switch temperature sensors. Safety regulation products have obtained UL, VDE, CCC, CQC, KC, PSE, CB and other relevant certifications. All products meet the requirements of RoHS directive and reach regulations. The company has passed ISO9001 and ISO14001 system certification. The products are widely used in digital, power supply, communication, household appliances, photovoltaic products, LED lighting, new energy vehicles, transportation, instruments, electric tools and other electronic power supply and system protection

**主要展品 /Products**

电流保险丝、片式精密电流感测电阻、温度开关温度传感器

**深圳市蓝巨科技有限公司**  
**SHENZHEN RAYSR TECH CO., LTD.****W2-2A22**地址: 深圳市宝安区西乡街道富华社区创富 3 号厂房 2 楼 (518101)  
电话 /Tel: 86-755-23719504  
传真 /Fax: 86-755-23719504  
网址 /Web: www.raysr.com.cn

深圳市蓝巨科技有限公司是一家专业从事 LED UV 应用产品的系统研发和生产的高科技企业。主要涉及印刷油墨固化、光纤固化、饮水及空气杀菌等行业的 LED UV 应用产品的研发、生产及销售。产品范围涵盖从 UV-A 到 UV-C 的全系列。

蓝巨以客户需求为导向, 以技术研发为支撑, 核心人员自 2005 年开始从事 LED 相关项目研发及生产管理, 经过 15 年的沉淀。

Shenzhen Raysr Technology Co., Ltd. is a high-tech enterprise specializing in the system development and production of LED UV application products. It mainly involves the R & D, production and sales of LED UV application products in printing ink curing, optical fiber curing, drinking water and air sterilization industries.

**主要展品 /Products**

UV LED 模组, UV 杀菌上水器, UV LED 静态和过流杀菌灯, 光触媒空气净化器, 紫外 LED 模组加工 UV LED module, UV sterilization water supply device, UV LED static and over-current sterilization lamp, Photocatalyst air purifier, UV LED module processing

**leleduo****深圳市乐乐多科技有限公司**  
**Shenzhen LeLe Duo Technologyco., Ltd.****E3-3A20**地址: 广东省深圳市宝安区 33 号方兴科技园 C 区 19 栋 201 (518100)  
电话 /Tel: 0755-28999703  
网址 /Web: http://szleleduo.com/zh\_cnindex.htm

深圳市乐乐多有限公司是国内创意消费电子产品、智能家居、新奇特产品的知名企业。我司致力于创意消费电子产品、智能家居、新奇特产品的研发, 生产与销售; 设计师的创作灵感来源于时下年轻人对个性风格, 生活品位的追求。产品拥有前卫的设计理念, 精湛的制作工艺, 引领着时尚达人、办公白领的消费潮流。我们的主旨: 让创意无处不在, 生活充满乐趣和方便。我司始终坚持以品质至上, 创新为主, 快乐感恩, 诚信共赢的核心价值及服务理念。

**主要展品 /Products**

创意消费电子产品, 香薰机, 加湿器, 挂脖风扇, 创意台灯, 暖风机, 暖手宝

**深圳市力合微电子股份有限公司**  
**Leaguer MicroElectronics Corp.****W3-3F81**地址: 深圳市南山区清华信息港科研楼 11 楼 (518057)  
电话 /Tel: 0755-26719968  
传真 /Fax: 0755-26957410  
网址 /Web: www.leaguerme.com

力合微电子是行业领先的物联网通信芯片企业, 20 余年深耕于电力线通信技术与芯片开发, 是电力线通信国家标准执笔人, 科创板首家 PLC 芯片企业。针对物联网应用, 公司推出电力线统一通信接口协议 PLBUS, 为市场提供 PLC 芯片、模块及应用解决方案, 并提供芯片原厂技术支持。其核心技术与产品广泛应用于智能家居、智能家电、智能照明、城市道路照明、能效管理、智慧光伏、工业物联网等领域, 实现“有电线, 即可通信”。

Leaguer MicroElectronics Corp. (LME) is the leader of IoT communication chip company in China, focusing on power line carrier communication (PLC) technology and IC design development. Basing on deeply conception of high functional PLC technology and high reliable chip technology, LME participate in the formulation and revision of national standards 12pcs, and provide PLC chips and modules application solutions to IoT terminal manufacturers, solution providers and platform enterprises. The core technology and products used in smart home, smart home appliances, smart lighting, energy management, rail transit, charging pile and industrial IOT etc, realized "have power line, can communication".

**主要展品 /Products**

物联网通信芯片及模块、PLBUS PLC 电力线通信芯片、PLBUS PLC 电力线通信模块、PLBUS PLC 智能家居网关、PLBUS PLC 宽带电力线通信芯片、PLC 智能家居通信芯片、PLC 智能家电通信模块等

IoT chips and modules, PLBUS PLC chips, PLBUS PLC modules, PLBUS PLC smart home gateway, PLBUS PLC smart home IC &amp; Modules



MAOOXD

深圳市冒险岛工业设计有限公司

W4-4B27

MAOOXD

地址: 广东省深圳市宝安区西乡街道劳动社区宝源路 1065 号 F518 时尚创意园 F3 栋 F3-401 (518100)

电话 /Tel: 15012907157

网址 /Web: www.maooxd.com

深圳市冒险岛工业设计有限公司 2021 年成立, 团队由一群富有激情且朴实的设计师组成。专注于创新产品设计和探索; 执着于追求设计出体验完善, 有差异化的产品。

主要经营范围包含: 创新产品设计、爆品策略与定义、创意结构研发、包装创新设计、品牌形象与创意等。

#### 主要展品 /Products

卡尔蔡司万花筒眼镜盒、DEFENCE 手机壳, 智能微压电炖锅、BelleMa 吸奶器、宇航员暖手宝, 羊驼暖手宝, 蒸汽朋克电子烟, 电动牙刷, U 型儿童牙刷、玻璃隔水炖等。



宁波龙巍环境科技有限公司

N2-2A24 2A25

Ningbo Lonwe environment technology co., LTD

地址: 浙江省宁波杭州湾新区金溪支路 23 号 (315000)

Add: 23 jinxi road, hangzhou bay new area, ningbo city, zhejiang province, China

电话 /Tel: 0574-23669968

传真 /Fax: 0574-63566069

网址 /Web: www.lonwe.com.cn

龙巍科技创建于 2006 年, 是一家面向全球的绿色环保饮用水设备专业制造企业, 占地 55 亩, 建筑面积 59000 平方米。

公司获得 ISO9000 质量管理体系认证、ISO14000 环境管理体系认证、OHSAS18000 职业安全健康管理体系认证, 通过 3C、CE、CB、ROHS 等十几个国内外认证, 现已发展成为国家高新技术企业、国家知识产权贯标企业、国家级知识产权优势企业、水利部先进实用技术重点推广企业、工信部两化融合管理体系评定企业、国家科技型中小企业、浙江省 AAA 级“守合同重信用”企业等, 累计起草行标团标 7 项, 拥有 200 余项专利资质。

#### 主要展品 /Products

卡尔蔡司万花筒眼镜盒、DEFENCE 手机壳, 智能微压电炖锅、BelleMa 吸奶器、宇航员暖手宝, 羊驼暖手宝, 蒸汽朋克电子烟, 电动牙刷, U 型儿童牙刷、玻璃隔水炖等。

Ningbo lonwe Environmental Technology Co., Ltd. was founded in 2006 and is a professional manufacturer of green environmental protection drinking water equipment. The company covers an area of 55 acres, with a construction area of 59,000 square meters, more than 500 employees, and a total investment of 180 million yuan.

The development of the lonwe brand has always adhered to a down-to-earth development strategy. It has cooperated with CCTV, local satellite TV and other media to promote the brand image to multiple channels in the afternoon, insisted on participating in nearly 100 domestic and

foreign industry exhibitions, and won unanimous praise from domestic and foreign customers. With the continuous improvement of the popularity of the lonwe brand, the outlets have gradually covered the whole country. On September 8, 2015, Long Wei officially signed with Huang Rihua, the star of Guo Jing, a Hong Kong film star "The Legend of Condor Heroes", and officially became the spokesperson of the Long Wei brand image. The development of the Long Wei brand has ushered in another peak.

With the continuous development and growth of the lonwe brand, the company has figured out a complete set of business model to feed the network marketing model, so that every customer who joins lonwe can grow rapidly, from store decoration to new store opening, and then to In the business education meeting, there are dedicated people to help you start the market. The company has set a special fee to provide advertising support to national agents to enhance the brand image and market share, boost market sales, service terminal channel providers, and products are exported to Southeast Asia, Africa, the Middle East, More than 80 countries and regions including Europe and South America.

#### 主要展品 /Products

400-1400 加仑反渗透净水机、中央净水机、中央软水机、管线机、商用工程机、富氢水机、富氢水杯、富氢吸喝一体机

400-1400 gallon reverse osmosis water purifier, central water purifier, central water softener, pipeline machine, commercial engineering machine, hydrogen rich water machine, hydrogen rich water cup

MFrontier

美思先端

深圳市美思先端电子有限公司

W4-4B13

Shenzhen MFrontier Electronics Co.,Ltd.

地址: 深圳市光明区凤凰街道凤凰社区招商局光明科技园 B1B2 栋 B2-301 (518107)

Add: B2-301, China Merchants Guangming Science &amp;Technology Park,Guangung Road 3009, ShenZhen, China

电话 /Tel: 0755-21386871

传真 /Fax: 0755-23243370

网址 /Web: www.memsf.cn

美思先端历经 7 年深耕细作, 构建了温度、气体、压力、粉尘、流量、光学组件六大产品体系, 成功研制了 50 多种 MEMS 传感器与模组、100 多种精密光学组件, 可广泛应用于智慧家电、汽车电子、锂电池热失控、暖通空调、医疗器械、消费电子、工业监测、安防监控、智慧能源、智慧农业、航空航天、公共安全、半导体等领域。

MFrontier is the MEMS sensor and precision optical manufacturer and service provider. It is willing to provide customers all over the world with high performance temperature sensors, gas sensors, pressure sensors, PM2.5 sensors, flow sensors, precision optical components and share its professional application experience.

#### 主要展品 /Products

MEMS 红外温度传感器系列产品、压力传感器系列产品、气体传感器系列产品、颗粒物传感器系列产品、中远红外波段滤光片系列产品、模组系列产品

MEMS infrared temperature sensors, gas sensors, pressure sensors, particulate matter sensors, mid-to-far infrared filters, etc





### 深圳市盟迪奥科技股份有限公司

E2-2B04

地址: 深圳市龙岗区朱古石工业区朱古石路 92 号 B 厂房 (518111)

电话 /Tel: 13828724061

传真 /Fax: 0755-84693936

网址 /Web: www.szmondial.net

深圳市盟迪奥科技股份有限公司成立于 2001 年, 是一家年轻, 富有活力及创新的民营企业。公司集研发, 设计, 开发, 销售, 服务为一体, 是专业的生产商, 提供自研产品 OEM 贴牌生产, ODM 设计研发定向制造, 以及带开模加工等服务。目前拥有员工 1500 人, 其中研发工程师 50 多人, 包括电子, 结构, ID 外观设计等细分部门。盟迪奥科技将为缔造高品质的产品而加倍努力, 为环保事业出一份力量!

#### 主要展品 /Products

厨余垃圾处理处理器、电水壶、电煮锅、咖啡机、多士炉、电磁炉



### 深圳市敏杰电子科技有限公司

N2-2A21

#### Shenzhen Minjie Electronics Technology Co.,LTD.

地址: 深圳市宝安区石岩街道办塘头大道辉业科技园 1 栋 4 楼 (518108)

Add: Floor South .1 seat building .Huian Da Industrial Park .Tangtou Ave,Shiyan Street,Baoan District,Shenzhen.China

电话 /Tel: 86-0755-29979191

传真 /Fax: 86-0755-29123213

网址 /Web: www.mj-sensor.com

深圳市敏杰电子科技有限公司是一家专注研发、生产、销售和服务于 NTC (负温度系数) 热敏电阻和各类 NTC (负温度系数) 温度传感器的国家高新技术企业。

目前具备年产 4 亿只高精度 NTC (负温度系数) 热敏电阻, 8000 万只 NTC (负温度系数) 温度传感器的生产能力, 并可根据客户要求定制化设计、生产各类高精度 NTC (负温度系数) 热敏电阻和温度传感器。

Shenzhen Minjie Electronics Technology Co., Ltd. is a dedicated R & D, production. Sales and service in NTC (negative temperature coefficient) thermistor and all kinds of NTC (negative temperature coefficient) temperature sensor national high-tech enterprises, its products have been widely used in domestic and foreign household appliances, electric tools. Beauty salon, medical instruments, transportation, storage logistics, industrial equipment, smart wear, Internet of things temperature control and other well-known enterprises.

MINJIE in Shenzhen, Foshan, Anhui are equipped with the factory currently has an annual output of 400 million PCS high precision NTC (negative temperature coefficient) thermistor, 8000PCS temperature sensor production capacity, and can be customized according to customer requirements, design, production of various kinds of NTC (negative temperature coefficient) and thermal electronic temperature sensor.

#### 主要展品 /Products

NTC 热敏电阻、温度传感器

NTC (negative temperature coefficient) thermistors and various NTC (negative temperature coefficient) temperature sensors.



mochuang

### 深圳市魔品科技有限公司

E2-2A15

#### Shenzhen Mopin Technology Co.,Ltd.

地址: 深圳市龙岗区坂田街道岗头社区宝能科技园 (南区) 10 栋 19 楼魔创 (518129)

Add: Room 1901B, B2 Building, B Area, 1 Phase, South of BaoNeng Science and Technology Park,Qinghu industrial Area,Gangtou Community,Bantian Street,Longgang District,Shenzhen City,China

电话 /Tel: 0755-21003830

传真 /Fax: 0755-21003830

深圳市魔品科技有限公司隶属于深圳市魔创优品科技集团, 是一家创新型高科技公司, 总部在深圳, 拥有深圳研发中心和深圳营销中心, 并在东莞拥有 30000 多平方米的家电产品生产基地。公司主要研发设计具有高端品质和独特设计的家电类产品, 其中全世界首创多功能干脚机, 以其时尚的外观, 精致的工艺和高品质的品质, 深得消费者信赖, 成为家电行业的一匹黑马! 旗下产品远销 90 多个国家和地区, 并在国内打造了良好的品牌效应。

Shenzhen Mopin Technology Co., Ltd. belongs to Shenzhen Mochuang Youpin Technology Group. It is an innovative high-tech company headquartered in Shenzhen. It has a Shenzhen R&D center and a Shenzhen marketing center. It also has more than 30,000 square meters factory for home appliances in Dongguan. The company mainly develops and designs home appliances with high-end quality and unique designs. Among them, the world's first multi-functional foot dryer, with its fashionable appearance, exquisite craftsmanship and high-end quality, has won the trust of consumers and has become a leader in the home appliance industry. Its products are exported to more than 90 countries and regions, and have built a good brand in China.

#### 主要展品 /Products

魔创暖风干脚机, 历经 2 年精心设计, 全世界首创!

强劲风力, 15 秒快速干脚, 暖风舒适;

等离子除菌, 抑制脚气;

室内除菌, 祛除异味;

原创风道设计, 多重保护, 安全无忧;

送礼优选, 为爱而生!

Mochuang Multi-functional Foot Dryer, with 2 years of meticulous design, the world's first design!

It has strong wind, to dry feet quickly in 15 seconds, warm and comfortable;

Plasma sterilization, inhibit athlete's foot;

Sterilize indoors and remove peculiar smells;

Original air duct design, multiple protections, safe and worry-free;

Best gifts, born for love!

**ODNOVEO 欧蒂诺\***

\* 艺术之家 | 品位之选 \*

**深圳市欧蒂诺科技有限公司****Shenzhen odnoveo technology co., Ltd****N4-4A45**

地址: 广东省深圳市宝安区松岗街道沙浦社区广进路 33 号

Add: No.33 Guangjin Road, Shapu Community, Songgang Street, Baoan District,  
Shenzhen City, Guangdong Province

电话 /Tel: 0755-27138237

Shenzhen Odino Technology Co., Ltd. perfectly combines classical music culture with modern vocal music technology, and makes quality audio-visual life enter thousands of families with the help of craftsman spirit and design aesthetics. Odino & Yarrantik has a team with high quality, excellent technology and strong sense of responsibility, integrating production, R&D and sales, and all links have achieved international-level operation and management. The company has a complete set of production lines for woodworking, polishing, painting, electronics, quality and packaging.

**主要展品 /Products**

留声机, 蓝牙音响, 落地钟, 壁炉

Phonograph, Bluetooth stereo, floor clock, fireplace

**PUREST**

浦力适

**深圳市浦力适贸易有限公司****Shenzhen Purest Trading Co.Ltd****E1-1H71**

地址: 深圳市宝安区福海街道桥头社区福瑞路 1 号立新湖创意园 1 号楼 220 (518103)

Add: 220, building 1, lixinhu Creative Park, No. 1, Furui Road, Fuhai Town, Bao'an District,  
Shenzhen

电话 /Tel: 0755-33119951

传真 /Fax: 0755-33119952

网址 /Web: <http://www.purestlife.com.cn/>

1992 年于深圳市宝安区沙井镇大王山村工业区设厂, 厂房面积约 20,000 平方米, 迄今为止, 发展成为拥有自主专业研究与开发团队、注塑部、马达部、PCB 无铅生产设备一惯化作业的专业生产厂, 产品经过世界各知名品牌质量认可, 于 1998 年荣获 ISO- 质量认证的肯定, 更于 2013 年因业务量增加进行扩产完成, 成为年产量百万台级专业化生产工厂, 产品制作质量精良、稳定, 业界皆有口碑。除湿机产品荣获德国红点奖肯定。

Our plant set up in shenzhen in 1992, our plant covers approximately 20,000 square meters. With 20 years solid experience, we are one of the specialized manufacturers in dehumidifier, we take seriously on quality control following by ISO 9001 standard.

Our brand "PUREST" set up in 2012.

**主要展品 /Products**

除湿机加湿器, 空气净化机

Dehumidifier, Humidifier, Air purifier

**普 | 晟 |**  
**PRO SENSE****深圳市普晟传感技术有限公司****ProSense Technologies Co., Ltd.****W1-1B44**

地址: 深圳市龙华区大浪街道联建工业园 4 栋 (518110)

Add: Building 4, LianJian S&amp;T Park, DaLang, LongHua District, ShenZhen

电话 /Tel: 86-0755-36690079

传真 /Fax: 86-0755-36690079

网址 /Web: <http://www.szprosense.com>

深圳市普晟传感技术有限公司隶属于河南省日立信股份有限公司, 是日立信倾力打造的气体检测领域王牌企业, 公司在气体检测领域拥有数十项专利及非专利核心技术, 拥有一支跨学科经验丰富的高科技产品研发队伍, 建有一流的气体传感器开发基地以及自动化生产老化校准系统。我们热诚期待与欢迎您的合作, 携手共同推动中国及世界的检测技术的进步。普晟公司是全球甲醛检测专家 ---- 英国 DART SENSORS 全球唯一指定生产商。

ProSense Technologies Co., Ltd, invested and run by Relations, is aimed to be a world leading company in gas sensing field and owns several tens of patents & non-patent core technology about gas sensing. ProSense employs high qualified professionals and personnel with extensive experience and is equipped with state-of the art laboratory for R&D and automatic production line. ProSense provides more than 100 types of high quality sensors, among which are supported noble metal catalyst, gas diffusion electrode, MEA, gas sensor with long service life, gas sensor with solid electrolyte or polymer electrolyte, gas sensor based on fuel cell technology, electrochemical sensor, lead free oxygen sensor based on fuel cell technology, etc. You can rely on ProSense for reliable gas sensing module and gas sensing solution.

ProSense is the sole dominated manufacture of HCHO detection module for DART SENSORS.

**主要展品 /Products**

电化学甲醛气体传感器、甲醛检测模组、VOC 传感器 / 模组、CO 传感器 / 模组、氢气传感器 / 模组、氨气传感器 / 模组、硫化氢传感器 / 模组等。

**启明云端****深圳市启明云端科技有限公司****Wireless-Tag Technology Co., Ltd.****W4-4H76**

地址: 深圳市南山区国际创新谷 6 栋 A 座 8 层 801-806 (518000)

Add: Room 801-806, 8th Floor, Block A, Building 6, International Innovation Valley, Nanshan  
District, Shenzhen, China

电话 /Tel: 13501555020

网址 /Web: <http://www.wireless-tag.cn>

深圳市启明云端科技有限公司作为领先的物联网通讯产品和整体解决方案提供商, 为全球企业客户提供无线通讯产品及场景智能化服务。公司主要提供物联网无线通讯芯片、模组、人机界面 (HMI)、人工智能及工业控制嵌入式产品等, 方案已服务全球超过 1000+ 企业, 特别是在智能电网、智能家居、智慧工业、医疗、农业监测等领域积累了丰富的产品和项目经验。

Wireless-Tag Technology Co., Ltd. ("Wireless-Tag" for short) is a leading provider of Internet of Things communication products and overall solutions in China. The company mainly provides Internet of Things WIFI, Bluetooth wireless communication chips, modules, and human machine

interfaces (HMI), Artificial intelligence and industrial control embedded products, and the solutions we provided have served more than 1,000 companies worldwide.

#### 主要展品 /Products

物联网无线通讯芯片模组、HMI 人机界面、86 盒旋屏解决方案、家电彩屏应用解决方案、WIFI6、工控主板、串口屏

IoT wireless communication chip module, HMI human-machine interface, 86 box rotary screen solution, home appliance color screen application solution, WIFI6, industrial control motherboard

## KEEWOO 启为

让清洁更简单

### 深圳市启为机器人技术有限公司

E1-1C01

地址: 深圳市宝安区西乡街道共乐社区铁仔路 50 号凤凰智谷 B 栋 306 (518101)

电话 /Tel: 0755-23501780

启为机器人成立于 2020 年 3 月, 位于深圳市宝安区, 是一家聚焦家庭智能清洁领域的科技公司。公司坚持以用户为中心, 以创新为驱动力, 团队在产品开发上注重底层清洁技术研究, 并回归清洁工具的本质“干净 + 好用”。凭借团队超强的创新能力及对产品的深刻理解, 已在仿生清洁技术、干湿两用真空吸尘技术、深度自清洗、UV 秒杀除菌、创新水气分离等技术方向取得突破, 并获得国内外专利, 成功推出行业领先的 C260 系列洗地机。

#### 主要展品 /Products

C260 只能洗地机系列。省力清洁不留污, 快速烘干易维护。吸尘, 洗地, 清洁一步到位。拥有防缠绕污水箱, 领先行业的一键自清洁, 2' 30" 的快速烘干, 三大清洁模式, 大容量清水箱, 大容量高效电池。

JOVS

### 深圳市千誉科技有限公司

#### Shenzhen Qianyu Technology Co., Ltd.

E3-3H11

地址: 广东省深圳市南山区科兴科学园 A2-1002 (518000)

电话 /Tel: 18819440884

网址 /Web: www.jovsbeauty.com

JOVS 是一个时尚个护品牌, 专研创新美容科技, 主打脱毛仪、美容仪等新一代智能美护产品, 与用户共创肌肤护理的功效价值和情绪价值。我们将护理功效和舒适体验作为核心命题, 致力于研发创新型产品, 让用户从耗时、无效的肌肤护理中解放, 体验更轻松、愉悦的有效呵护, 进而捕获由内而外的良好状态, 从容生活、追求热爱。

JOVS is a trendy personal-care brand specializing in innovative beauty technology. It features hair removal devices, beauty instruments and other new intelligent beauty products. The innovative brand has been co-creating the efficacy value and emotional value of skin care with users. We are committed to developing innovative products with the core proposition of skin care efficacy and comfortable user experience. Our users can be liberated from time-consuming and ineffective skin care, and experience more relaxed and pleasant effective care. They are then able to achieve a fine state from the inside out, live a leisure life, and pursue what they love.

#### 主要展品 /Products

JOVS 黑金冰点嫩肤仪;

JOVS 多功能冰点蓝宝石家用脱毛仪;

JOVS Venus II 冰点多功能脱毛仪;

JOVS Venus Hpro 冰点脱毛仪 - 海外专供;

JOVS Dora 全触控多功能脱毛仪

JOVS Blacken Freezing Point Skin Rejuvenation Device;

JOVS Multifunctional Freezing Point Sapphire At-home Hair Removal Device;

JOVS Venus II Multifunctional Freezing Point Hair Removal Device;

JOVS Venus Hpro Freezing Point Hair Removal Device-Overseas Only;

JOVS Dora Smart Touch Multifunctional Hair Removal Device

## 小厨凉

### 深圳市勤毅尚品电子有限公司

W3-3H86

地址: 深圳市宝安区沙井街道大王山社区沙井路 4-2 号四层

电话 /Tel: 0755-29795892

网址 /Web: www.iwatch.cc

勤毅尚品于 2001 年在东莞清溪成立, 是以家用电器、数码等产品的研发为导向的企业。

持续开发独创的、实用的、好用的、耐用的、并能解决刚性需求的产品, 是我司立足的根本与最核心的营销理念。

#### 主要展品 /Products

小厨凉, 厨房专用冷风扇, 开机秒出冷风, 做饭不再酷热。不影响油烟与火苗, 即买即用免安装。

Relish

### 深圳市日丽丰科技有限公司

#### Shenzhen Relish Technology Co., Ltd

E3-3B40

地址: www.relish-tech.com.cn (518000)

电话 /Tel: 0755-89339077

传真 /Fax: 0755-89339077

公司主要致力于设计、研发、销售口腔护理产品, 占地面积达 2 万平方米, 并获得高新技术企业并取得上百项产品专利。通过 ISO9001、ISO13485、BSCI 的系统认证及美国 FDA 注册; 产品取得 CB, CETL, FCC, CE, PSE, FDA, KC 证书。产品出口至美国、欧洲、韩国、日本等全球各地。同美国沃尔玛、霍尼韦尔、海尔、舒客、飞科等国内外知名企业建立了长期的合作伙伴关系。

Established in 2012, Shenzhen Relish Technology Co, Ltd. is a professional manufacturer and exporter which carries design, development, production of Oral Care products, and granted with National High-tech Enterprise in 2016. Covering an area of 20000 square meters, Relish has over 300 silful employees, senior engineers & professional marketing personnel s. All products, with dozens of national patents, comply with international quality standards and are greatly valued in wide varieties of markets throughout the world.

**主要展品 /Products**

电动牙刷, 冲牙器, 牙刷消毒器。

Electric Toothbrush, Water Flosser, Toothbrush UV Sanitizer



**深圳市荣为信科技有限公司**  
**Shenzhen Rongweixin Technology Co., Ltd.**

**E2-2A26 2A27**

地址: 广东深圳宝安田洋三路 8 号

电话 /Tel: 13632916199

网址 /Web: www.szrwkj.com

荣为信是一家专业研发和生产开关电源、充电器、线性电源等。公司成立于 2010 年, 公司主要电源 3W-150W, 充电器 5W-50W, 定制电源从 5W-350W, 主要应用于消费类电子 (IT/AV 类, 灯饰, 保健医疗, 家电, 安防、多媒体、机器设备、工业设备等领域。已获得 CB, EMC, UL/TUVus, ETL, GS, BS, SAA, CCC, KC, PSE, FCC, CE, LVD, C-TICK, RCM 等全球安规认证。

Shenzhen Rongweixin Technology Co., Ltd was founded in 2010, with 5000 square modern production workshop ,with four complete automatic production line. We have advanced lead-free wave soldering , Automatic aging and high precision power supply comprehensive tester. We could meet your large orders and urgent requirements ,Monthly production capacity With 1.5 million pcs. We have high-quality management team, the international leading RD and the perfect quality system.To cater for the needs of global customers, we lived up to safety standards set by many different countries, such as CB, EMC, UL/TUVus, ETL, GS, BS, SAA, CCC, KC, PSE, FCC, CE, LVD, C-TICK, RCM, etc.

**主要展品 /Products**

电源适配器, 低频变压器, 裸板, 电池包

AC adapter ,linear power supply ,battery pack



**深圳市瑞比德传感技术有限公司**  
**Shenzhen RPD Sensor Technology Co., Ltd.**

**N4-4A37**

地址: 深圳市宝安区西乡街道前进路林果所恒明珠工业园 C 栋 6 楼西座 (518126)

Add: 6th Floor, Building C, Hengmingzhu Industrial Park, Baotian Industrial Zone, Xixiang,

Bao'an District, Shenzhen, China

电话 /Tel: 0755-32865605

传真 /Fax: 0755-27211825

网址 /Web: http://www.rapild.com/

深圳市瑞比德传感技术有限公司是一家研发和生产各种温度传感器的高新技术企业, 公司主要生产铂电阻温度传感器、热电偶、NTC 温度传感器、DS18B20 数字温度传感器和各提供种温度传感器解决方案, 同时公司和国外知名 NTC 芯片生产商: 日本 Semitec、Shibaura 和韩国 LTR, 以及德国的 Heraeus 等合作, 共同研发和生产各种温度传感器, 深得广大客户的信赖!

Shenzhen RPD Sensor Technology Co., Ltd. is a high-tech enterprise of temperature sensor, temperature module with our R & D team and production plant. We are professional in producing NTC/ PTC/ thermocouple and other temperature sensors. Also we are cooperating with many foreign well-known NTC chip manufacturers like Semitec, LTR, Shibaura & Heraeus, and we help our clients with kinds of temperature sensors in home appliance, automobile climate control system, automotive IAT sensor, industrial instruments and medical thermometer with good reputation! Since our establishment, we follow "Quality is the first" with strict quality control and good services. RBD trusts quality is the life and will pursue excellence and constant improvement together with our clients.

**主要展品 /Products**

NTC 热敏电阻元器件 NTC 温度传感器 铂电阻传感器 DS18B20 温度传感器 红外线温度传感器 Thermocouple PT100/PT1000 Temperature Sensor DS18B20 Temperature Sensor NTC Temperature Sensor Wiring Harness



**深圳市瑞松电器有限公司**

**E1-1F71**

地址: 深圳市龙华区观湖街道观城社区环观南路 105-20 号 5 层 (518000)

电话 /Tel: 29401566

传真 /Fax: 29401566

网址 /Web: www.luftrum-se.com

深圳市瑞松电器有限公司成立 2010 年, 是一家专注于空气处理解决方案公司, 2014 年与瑞典品牌 luftrum 达成战略合作协议, 全面代理该品牌的研发, 生产, 销售。我们一直秉持“创新、格调、健康、品质”的品牌经营理念, 通过开放式创新、卓越运营管理、人力资源发展等战略的实施, 全面构造公司的核心竞争力, 创造客户和社会的价值, 从而实现科技创新技术价值, 赢得了广大客户和社会的一致好评。

Founded in 2010, Shenzhen Ruisong Electric Appliance Co., Ltd. is a company focusing on air treatment solutions. Three years after its establishment, it has become a leader in the industry and continuously provides air treatment solutions to many first-line brands. In 2014, it reached a strategic cooperation agreement with luftrum, a Swedish brand, to fully represent the R & D, production and sales of the brand. We have always adhered to the brand management concept of "innovation, style, health and quality". Through the implementation of strategies such as open innovation, excellent operation management and human resource development, we have comprehensively constructed the company's core competitiveness and created the value of customers and society, so as to realize the value of scientific and technological innovation and win the unanimous praise of customers and society.

**主要展品 /Products**

空气净化器、空气质量检测仪、车载净化器、新风系统、加湿器、净化循环风扇等空气检测、净化设备  
Air purifier, Air quality monitor, Car air purifier, Ventilation system, Humidifier, Fan...





### 深圳市萨魔科技有限公司

E3-3B04

地址: 深圳市宝安区福永和盛工业区 3 栋 2 楼 (518000)

电话 /Tel: 0755-23608948

传真 /Fax: 0755-23608948

深圳市萨魔科技有限公司是一家集研发、生产、销售为一体的企业。公司有超过 10 年的电子产品制造经验,萨魔科技于 2016 年 2 月正式成立。公司专业开发、生产、销售电动牙刷产品,占地面积 3500 m<sup>2</sup>,公司拥有由多位资深行业经验工程师组成的研发部门。公司目前已经通过 ISO9001 质量管理体系,公司产品均已通过 CE、ROHS、FCC、FDA 等多项国际认证及国内 CMA 质量检测认证。

#### 主要展品 /Products

成人声波电动牙刷、儿童声波电动牙刷、牙刷消毒盒、冲牙器



### 深圳市三利达电器科技有限公司

W1-1A16 1A17

#### Shenzhen Sanlida Electrical Technology Co., Ltd

地址: 深圳市龙岗区龙岗街道五联社区将军帽小区 27 号 A 栋 101

电话 /Tel: 0755-89239506

网址 /Web: <https://www.sanlidaco.com/>

深圳市三利达主要是生产,设计,研发一体的实力工厂。主要是厨师机、食物料理机等厨房小家电产品,特别是在厨师机领域,已形成了自己的优势,产品远销欧洲,美洲,中东等国家地区。并以其可靠的质量,合理的价格和完善的售后服务,深受广大客户的好评。公司现拥有专业技术人员占总人数的 30%,高级研发工程师,产品设计工程师占技术人员的 20%,大量研发经费投入政策,通过不断的技术创新和流程改造来促进品质的腾飞。

#### 主要展品 /Products

厨师机、气泡水机、家用搅拌机

Stand mixer, Sodar maker



### 深圳市三赢为电子科技有限公司

W4-4A22

#### SANWIN ELECTRONIC TECHNOLOGY CO.,LTD

地址: 深圳市宝安区松岗街道立业路 8 号 (518018)

Add: NO.8,LIYE ROAD,SONGGANG,BAOAN,SHENZHEN,CHINA

电话 /Tel: 0755-29721099

传真 /Fax: 0755-27136033

网址 /Web: [www.sanwin.info](http://www.sanwin.info)

深圳市三赢为电子科技有限公司”致力为客户提供高品质电子零件,主要产品种类有各种电子开关、音 / 视频插座、交直流电源插座、连接器、记忆卡座和其他的电子零部件。近年来,公司新产品研发完全与与主要客户索尼、三星、汤姆逊、华为等的产品设计同步,是上述公司的绿色伙伴成员,多年的优秀供应商。工厂于 1997 年取得 ISO9001 认证,2005 年取得 ISO14001 认证,2003 年开始执行

ROHS。

Sanwin is engaged in providing high quality electronic components. The mpany mainly involves in the production of electronic switch,audio/video jack,power socket,memory card socket and connector. for recent years,the company's new product development keeps in pace with the product design by the main users including sony ,samsung,thomsonand huawei.it is one of the green partners and years' excellent suppliers for the above mentioned companies.

The products are widely usde in digital products,digtal electrical appliance,communication equipment,mobile terminal,automobile electronics,and healthcare equipment. sin0-hong kong joint venture factory has accumulated 20 years' experiences in production of electronic components.it has employees beyond 2000,the factory is equipped with complete operational quality management system,excellent product equipments,davanced testing equipments and abundant inspecting measures,stable and experienced employees are theguarantee for the company to keep

#### 主要展品 /Products

开关类: 轻触开关 | 检测开关 | 多功能开关 | 拨动开关 | 按钮开关 | 骗码开关 | 门锁开关 | AC 电源开关 | 叶片开关 | 钮子开关 |

插座类: 耳机插座 | DC 电源插座 | RJ45 插座 | 光纤插座 | RCA 插座 | AC 电源插座 |

连接器类: USB 连接器 | 卡座连接器 | 板对板连接器 | 排针排母 | 板对线连接器 | FPC/FFC 连接器 |

SWITCH: TACT SWITCH | DETECTOR SWITCH | MULTI-FUNCTION SWITCH | SLIDE

SWITCH | PUSH SWITCH | ENCODER

SWITCH | DOOR LOCK SWITCH | AC POWER SWITCH | LEAF SWITCH | TOGGLE SWITCH |

JACK: PHONE JACK | DC POWER JACK | RJ45 JACK | PHOTO LINK | RCA JACK | AC

POWER JACK |

CONNECTOR: USB CONNECTOR | CARD CONNECTOR | BTB CONNECTOR | PIN/FEMALE

HEADER | WAFER CONNECTOR |

FPC/FFC CONNECTOR |



### 深圳市森普高科电子有限公司

N4-4A46

#### Shenzhen SUNGPO Hi-Tech Electronic Co.,LTD

地址: 工厂地址: 东莞市凤岗镇碧湖大道雨湖路 9 号金银珠宝产业园 B 栋 5 楼

Add: Room 502, Building 2, No. 9, Yuhu Road, Fenggang Town, Dongguan City, Guangdong Province,China

电话 /Tel: 13928417767

网址 /Web: [www.sungpo.com](http://www.sungpo.com)

森普集团 (SUNGPO) 成立于 2011 年,是集研发、生产、销售和服务于一体的高新技术企业。

专注于运动健康、理疗养生、美容个护等产品的研发与生产,产品远销全球 70 多个国家与地区。

生产基地位于世界工厂东莞,通过 ISO9001 质量体系认证, BSCI 认证。

产品均通过 FDA、UL、CE、RoHS、FCC、UKCA 等相关国际认证。

十一年来森普人坚持匠心精神,专注于为客户提供从设计开发到生产的一站式服务。

Shenzhen SUNGPO Hi-Tech Electronic Co.,LTD.

Professional production of various massage fitness equipment and beauty personal care equipment.



A factory with 10000 square meters, 400 employees and a professional R&D team.  
The best selling is massage gun that produced 6000 pieces per day.  
Passed with SGS ISO9001, BV BSCI Audit for the factory.  
Product appearance patent certificate, CE, FCC, ROHS, MSDS, UN38.3, UL, FDA certification, etc.  
Our website is www.sungpo.com. Welcome to visit the company, hope that we can have a chance to work together.

#### 主要展品 /Products

EMS 理疗系列、腾讯动漫联名系列、金属按摩枪系列、专业运动按摩枪系列、Mini 按摩枪系列、超声波美容个护系列、波动 + 热疗仪器系列、养生仪器系列

EMS Physiotherapy Series, Tencent animation joint series, Metal Massage Gun Series, Professional fitness sports massage gun series, Mini Massage Gun Series, Ultrasonic Beauty Personal Care Series, Wave + Hyperthermia Instrument Series, Health equipment series



**SASWELL**  
森威尔

**深圳市森威尔科技开发股份有限公司**  
**SHENZHEN SASWELL TECHNOLOGY INC.**

**W1-1B40**

地址：深圳市龙岗区坂田街道岗头社区天安云谷产业园二期 4 栋 1601-1602  
电话 /Tel: 4006040098  
网址 /Web: <https://www.saswell.com.cn/>

创立于 2003 年，是一家创新技术驱动人居环境控制产品及系统解决方案的研发型科技公司，在 20 年为百余家大型企业提供产品及系统解决方案服务中，再利用物联网技术和节能改造实施，帮助客户减碳增效，促进数字化管理的同时，沉淀了强大的 5 大平台能力，并成为涂鸦云，阿里云、腾讯云、华为云的生态合作伙伴，得到了亚太、中东、北欧、东欧、俄罗斯、美国等全球客户的广泛认可。

SASWELL was formed in 1999, a professional in HVAC and microclimate with the goal of optimizing the living environment. Master electronic technology, HVAC fluid technology and intelligent communication technology, we bring those deep experience into thermostat, thermostatic radiator valve, actuator, control center and smart watering timer, every product we have in development.

SASWELL won high reputation by virtue of fast R&D speed, short production circle, high cost-effective.

We believe through energy efficiency and conservation, we can create a more sustainable world.

#### 主要展品 /Products

控制系统、水路系统、传感器、电工开关、智慧采暖、智慧两联供、智慧三恒五恒、智慧酒店、智慧浇花等众多领域提供一站式的整体解决方案。

# 3i

**深圳市杉川机器人有限公司**

**E1-1E31**

地址：深圳市南山区西丽街道松坪山社区北环大道 9018 号大族创新大厦 A 区 10 层  
电话 /Tel: 0755-86686756

深圳市杉川机器人有限公司成立于 2016 年，由杨勇博士带领的孔雀计划海外高层次人才团队创立。杉川是全球领先的移动机器人核心技术与服务提供商，致力于推动机器人及人工智能事业的持续发展。

杉川总部位于深圳南山，在硅谷、东京、深圳、北京、上海均设立研发中心，凝聚了来自卡内基梅隆大学、纽约大学、东京大学、香港大学、香港中文大学的优秀科学家以及行业领军人才，首创 Egomobile® 技术群并累积 901 项专利。

#### 主要展品 /Products

1. 3i 智能净地站
2. 3i 智能封装净味猫砂盆

# SHOKZ 韶音

**深圳市韶音科技有限公司**  
**Shenzhen Shokz Co., Ltd.**

**W4-4G81**

地址：深圳市宝安区石岩街道浪心社区石新社区山城工业区 26 栋厂房一层至四层 (518000)  
电话 /Tel: 0755-29988720  
传真 /Fax: 0755-29988720  
网址 /Web: <https://www.shokz.com.cn/>

韶音科技创立于 2004 年，是一家专注于电、声产品研发、设计、生产和营销的专精特新重点“小巨人”企业。韶音科技致力底层原创科技创新，自主研发骨传导、定向声场等声学技术，实现核心技术综合性的大幅提升，打造开放聆听不入耳的全新听觉体验。秉承着“用科技创新推动世界进步，让生活更美好”的企业使命，韶音科技正成为不断做出原创科技创新的平台型、生态型企业。

#### 主要展品 /Products

2022 年，韶音推出新一代户外运动系列旗舰款 OpenRun Pro。革命性升级的 Shokz TurboPitch™ 技术，让韶音运动声学体验突破性升级，低频音质更好听；黄金位置的双硅麦克风设计，让通话体验更顺滑无阻。此外，在佩戴舒适度、续航、操控等方面，该产品都有了质的飞跃。



**深圳市设际邹工业设计有限公司**  
**Shenzhen ZouDesign Industrial Design Co., Ltd.**

**E3-3H76**

地址：深圳市南山区招商街道港湾三路前海星科技园 D 座 (518000)  
Add: Building D, Qianhai Star Science and Technology Park, China  
电话 /Tel: 0755-21610656  
传真 /Fax: 0755-21610656

网址 /Web: www.id-zoudesign.com

深圳市设际邹工业设计有限公司于 2016 年创办, 团队集结了德国、澳大利亚、中国台湾等先锋人才, 屡次获得德红点、iF 奖、美国 IDEA 奖等国际设计大奖。同时, 多项设计作品成为美国 CES 展、香港电子展、全球 cosmoprofs 美容展、广交会等展会的焦点。聚焦个护美容, 服务企业有 likee、花西子、Silkn、雅萌、jovs、DJM、博思迪、美的、海尔、欧普照明、公牛、苏泊尔、迅雷、VIVO 等一线企业。

Shenzhen ZouDesign Industrial Design Co.Lt. was founded in 2016 by the founder/ chief designer Zhenmeng Zou. It is a national high-tech enterprise and one of the top ten industrial design companies in Shenzhen. The team has assembled pioneer talents from Germany, Australia, and Taiwan, and has repeatedly won the German Red Dot Award, the German iF Award, the American IDEA Award and other international design awards. At the same time, a number of design works have become the focus of exhibitions such as CES in the United States, Hong Kong Electronics Show, global cosmoprof beauty exhibition, and Canton Fair. Focusing on personal care and beauty, service companies include likee, Florasis, Silkn, YAMAN, DJM, and Bosidin. At the same time, other customers of cooperation also involve first-line enterprises such as Midea, Haier, Op Lighting, Siemens, Supor, Xunlei, VIVO and so on.

#### 主要展品 /Products

设际邹以爆品打造为核心服务, 通过营销型设计思维, 为一个个企业创造了适合各自企业发展的爆品, 如今设际邹的服务更是细分到单品爆款打造、产品系列升级、品牌设计解决方案三大模块, 计作品涉及“消费电子”、“智能硬件”、“智能家居”、“医疗美容”四大优势领域。

ZouDesign takes the creation of explosive products as its core service, and through marketing design thinking, has created explosive products suitable for the development of their respective companies for each company. Now ZouDesign's services are further subdivided into single product explosive product creation, product series upgrade. There are three major modules of brand design solutions, and the works involve the four dominant areas of "consumer electronics", "smart hardware", "home appliances", and "medical beauty".

## 施威德 SWIFT

深圳市施威德自动化科技有限公司

Shenzhen SWIFT Automation Technology Co.,Ltd.

W1-1B11

地址: 深圳市宝安区福海街道和平社区重庆路 190 号卓科科技园 3 栋一层、四层和四层 (518103)

Add: The 1st/4th floor, Building C, Zhuoke Science Park, No.190 of ChongQing Road, Heping Community, Fuhai Street, Baoan District, Shenzhen, China.

电话 /Tel: 86-0755-3317721-8

传真 /Fax: 86-0755-3317721-8

网址 /Web: www.sz-swift.cn

施威德成立十余年来, 一直专注于自动尼龙扎带机与尼龙扎带, 为国家高新技术企业。目前拥有 80 多项发明、实用新型及外观专利以及软件著作权, 国际 PCT 专利 10 余项。客户广泛分布于家电、线束、电机、汽车、光伏、食品或者化工包装、医疗、军工等各行各业。全球客户超过 1000 余家, 产品出口 50 多个国家与地区。施威德已经成为世界自动扎带机的顶级品牌。一直被抄袭, 从未被超越! 公司官网: www.sz-swift.cn

SWIFT/SWTAT--found in 2010, now become a world leader in the development and manufacturer

of Automatic cable tie tool and its cable ties, with more than 10+ PCT international patents, 80+ inventions patents as well as multiple software Copyrights. Not only in dominant position in China market, our products have been sold to more than 50 countries and regions (such as United States, Germany, UK, Italy, Netherlands, Spain, Hungary, Czech Republic, Romania, Slovenia, Slovakia, Poland, Israel, Turkey, Japan, Korea, Australia, Singapore, Thailand, Vietnam, Malaysia, India, Brazil, Mexico...), and have agents in Germany, UK, Italy, Poland, Turkey, India, Singapore, Korea & Mexico, with more than 1000 customers in worldwide.

#### 主要展品 /Products

手持式自动扎带枪 (散装扎带 / 连体扎带)

固定式扎带工具 (散装扎带 / 连体扎带)

马达定子扎带机 (散装扎带)

桌面式扎带机 (散装扎带)

全自动扎带机 (机械手, 散装扎带 / 连体扎带)

Auto cable tie gun (use loosen cable ties or strip cable ties)

Fixed type auto cable tie machine (use loosen cable ties or strip cable ties)

Auto cable tie machine for motor stator (use loosen cable ties)

Desktop auto cable tie machine (use loosen cable tie)

## SUNZONE

深圳市顺章电器有限公司

Shenzhen Sunzone Electrical Appliances Ltd

W1-1A40

地址: 广东省深圳市龙华区观澜镇五和大道 310 号金科工业园 B 栋 3 楼 (518110)

Add: 3 / F, Jinke Industrial Park, 310 Wuhe Avenue, Guanlan Town, Shenzhen, Guangdong, China

电话 /Tel: 075527559998

网址 /Web: https://www.sun-zone.com.cn/

深圳市顺章电器有限公司于 1994 年在深圳市科技园成立, 自成立以来一直专注于 PTC 陶瓷暖风机, 冷气扇以及加湿器等小家电产品的研发, 生产和销售。经过多年的发展, 顺章已经成为世界上最大的 PTC 陶瓷加热器的制造商之一, 年产量达 200 万台。顺章的产品远销世界各地, 现已成为众多国际知名品牌的合作厂商, 如 Delonghi, Honeywell, Lasko, Dimplex 等。

Shenzhen Sunzone Electrical Appliances Ltd, a mainland Chinese company, was founded 28 years ago in the Science Park of Shenzhen. Today, Sunzone becomes one of the largest manufactory of ceramic PTC heaters in the world, with quantity 2 million pcs per year. Sunzone's products have been sold to all the parts of the world during the past years, labeling many international brands, such as Delonghi, Honeywell, Lasko, Dimplex and so on. Sunzone is a subsidiary company of Jinke Group. Jinke is noted by the advanced ceramic PTC technology and manufacturing in the world, with 25% share in the global PTC component market.

#### 主要展品 /Products

PTC 陶瓷暖风机, 冷气扇, 加湿器, 风扇

Ceramic Heater, Air Cooler, Humidifier, Fan



### 深圳市四季电子有限公司

E3-3B30

地址: 深圳市宝安区沙井大王山第二工业区第 21 栋 (518104)

电话 /Tel: 0755-81499976

传真 /Fax: 0755-81499976

网址 /Web: www.vanilla-beauty.com

四季电子致力于个人护理及便携美容和健康仪器的研发和生产。产品线主要为清洁类, 按摩类仪器、射频仪、皮肤监测仪、洁牙仪等全线电子美容护理产品。公司为专业 OEM/ODM 生产厂家, 研发和制造团队位于深圳宝安沙井。自主完成从 ID 设计、电子和结构设计、到开模、生产装配和检测等完整流程。核心研发团队拥有个护产业丰富经验, 与品牌香奈儿、飞利浦等合作开发经验。目前已为多家品牌客人开发出畅销产品。

#### 主要展品 /Products

电动洁面仪, 射频多功能美颜仪, 射频塑性美体仪, 眼部按摩仪, 皮肤监测仪、洁牙仪等全线电子美容护理产品



天翔宇科技

HEATER  
——专业生产 PTC 加热器, 风能空调加热器

### 深圳市天翔宇科技有限公司

N2-2B50

#### Shenzhen Safevalue Technology Co., Ltd.

地址: 广东省深圳市龙华区观湖街道观平路 299 号深粮汽车电子特色工业园 十二栋 3、4 楼。(518110)

Address: 3F and 4F, Building 12, Shenliang Automotive Electronics Specialty Industrial Park, No. 299, Guanping Road, Guanhu Street, Longhua District, Shenzhen City, Guangdong Province.

电话 /Tel: 075528199818

传真 /Fax: 0755-25604970

网址 /Web: http://www.safevalue.com/

深圳市天翔宇科技有限公司成立于 2009 年, 是一家掌握先进 PTC 元件生产技术, 致力于 PTC 加热器件和 PTC 模块化产品研发和生产, 并为客户提供解决方案的生产型高新技术企业。天翔宇不断创新, 为客户提供高品质产品的同时, 也为客户提供 PTC 加热的解决方案。

Shenzhen Safevalue Technology Co., Ltd. Founded in 2009, Safevalue is a production oriented high-tech enterprise with advanced PTC component production technology, dedicated to the R&D and production of PTC heating devices and PTC modular products, and providing solutions to customers. Safevalue keeps innovating, providing customers with high-quality products, as well as PTC heating solutions;

#### 主要展品 /Products

天翔宇的 PTC 加热产品根据应用场景可分为: 空气加热、液体加热和固体加热三种类型。天翔宇秉承“服务至上、一对一定制”的服务宗旨, 为众多客户解决了痛点, 其中包括: 暖风机降低风阻 PTC 加热方案, 暖风机无异味 PTC 加热方案, 扫地机热风烘干方案, 洗地机抹布烘干方案, 布艺清洁机热水加热方案, 等等。

Safevalue's PTC heating products can be divided into three types: air heating, liquid heating, and solid heating. Adhering to the service tenet of "service first, one to one system", Safevalue has solved the pain points for many customers, including: The PTC heating scheme for reducing wind

resistance of a heater, The PTC heating scheme for a heater without odor, a hot air drying scheme for a floor sweeper, a scrubber cloth drying scheme, a cloth cleaner hot water heating scheme, and so on.



### 深圳市天正达电子股份有限公司

W3-3B15

#### Shenzhen Tianzhengda Electronics Co., LTD.

地址: 深圳市宝安区前进二路园艺园工业区 25 栋 4-6 楼 (518102)

Add: 4-6/F, Yuanyiyuan, 2Qianjin Road, Xixiang, Baoan, Shenzhen, China

电话 /Tel: 18902465771

传真 /Fax: 0755-27455298

网址 /Web: www.lcdstar.com

天正达创立于 1998 年, 已持续经营了 20 多年。2018 年在新三板挂牌上市, 证券代码: 873073。公司专注于新型显示触控一体化模组的设计和开发, 是一家集研发、制造、生产及销售于一体的国家高新技术企业。

产品广泛应用于智能工控、移动金融、智能家居、教育电子、智慧医疗、车载显示等领域。

先后获得 ISO9001、IATF16949、ISO14001、QC080000 认证等。

天正达, 值得长久信任!

Founded in 1998, Tianzhengda has been in operation for more than 20 years. The company completed the share restructuring in 2016 and was listed on the New Third Board on December 5, 2018. The stock code is 873073.

Tianzhengda is a national high-tech enterprise devoted to the research and development of new-type modules of touch and display integration module and integrated the research, manufacture, production and sales as a whole.

The company's products are widely applied in intelligent industrial control devices, mobile finance terminals, smart home appliances, educational electronics, smart medical instruments and automotive on-board monitors. The company has established long-term cooperation with many listed companies and enterprises of leading industrial brands.

Tianzhengda has passed certifications of ISO9001 & IATF16949, ISO14001, IECQ QC080000 has obtained strict quality audit certifications and created a good quality reputation.

Tianzhengda, worth of your long-term trust!

#### 主要展品 /Products

LCD 显示屏、OLED 显示屏、LCD+CTP 全贴合屏等

LCD Display Module、OLED Display Module、LCD+CTP Integrated Module etc.



**Timit**<sup>®</sup>**深圳市添美特科技有限公司****N3-3B32****TIMIT TECHNOLOGY CO.,LTD.**

地址: 深圳市南山区西丽街道松坪山社区科苑北路 78 号禹洲广场 A 座 1101-1103 (518000)

Add: Room 1101,11th Floor,Block A,YuZhou Plaza,No.78,KeYuan North Rd,NanShan

District,ShenZhen,China.

电话 /Tel: 86019635

传真 /Fax: 86019121

网址 /Web: www.timit.cn

[TIMIT] 以质量、交期、成本控制及逾 20 年的行业经验, 为您带来最适销产品。我们的产业位于珠三角与江浙地区。拥有月产百万台风扇, 八十万台电暖, 三十万台电水壶、十万台电动产品的产能。能为客户提供全链条的定制服务。我们的货物出口 150 多个国家。客户囊括各种类型。生产系统拥有 ISO、BSCI、SEDEX 等系统性认证, 产品拥有 ETL/GS/CB/CE/GCC/ROHS/LFGB 等系列认证。

TIMIT provide customers with the best electrical product solutions to meet local market demand. Quality, Delivery, Cost Control is our focus.

More than 20 years of experience in the Electrical industry will bring you the most marketable products.

Our industries are located in the Pearl River Delta and Zhejiang regions respectively.

We have a monthly production capacity of 1 million Fan, 800K Heater, 300K Electric Kettle, 100K Blender products capacity.

From Hardware, Plastic Injection to Assemble, from Mold development to maintenance, we can provide customers with a full chain of customized services.

Our goods are exported to Europe, North America, Australia, Middle East and more than 150 countries.

Our customers have offline Supermarkets, Chain stores, Wholesalers, & online selling and Mail Order Store.

Our production system has ISO、BSCI、SEDEX etc. Our products have ETL/GS/CB/CE/GCC/ROHS/LFGB etc.

**主要展品 /Products**

电取暖器, 电风扇, 冷风机, 空气净化器, 电热水壶, 搅拌机, 吐司机, 食物料理机, 打蛋机

Electric heater, Electric fan, Air cooler, Air purifier, Kettle, Blender, Toaster, Food processor,

Chopper, Hand mixer

**深圳市同创精密电子有限公司****E1-1A45****ShenZhen TopSharp Precision Electronics Co., Ltd**

地址: 深圳市宝安区西乡街道固戍社区西井路 21 号塘西第二工业区 A 区 D 栋 301/401/501/701/ 整层

电话 /Tel: 0755-23462931

传真 /Fax: 0755-27910631

深圳市同创精密电子有限公司成立于 2013 年主要致力于充电小风扇, 加湿器等创新小家电

产品的生产研发与销售。公司拥有 10 余年的产品自主开发经验以及强大的设计研发团队, 公司通过 BSCI,ISO9001:2015,TUV 等验厂审核, 公司拥有 8000 平米的办公和生产车间, 合作过的知名客户有韩国的 E-Mart, 日本的 Panasonic, 日本的无印良品与 Nitori, 欧洲的 LIDL 商场

Shenzhen Topsharp Precision Electronics Co., Ltd., established in 2007, has "HandFan" and "手风" two brands, which are mainly dedicated to the production, development and sales of innovative small household appliances such as mini rechargeable fans, power bank fans, mist fans, humidifiers and so on. As the first research and development manufacturer of handheld foldable rechargeable fans, we have more than 10 years of independent product development experience and a strong design and research team. Our company is more focused on product innovation and gets more than 120 invention patents, utility models, appearance patents and foreign PCT patents. Our company has passed BSCI, ISO9001:2015, TUV and other inspection audits. We has 8,000 square meters of office and production workshop and has more than 300 employees. The Well-known customers that have cooperated include E-Mart in South Korea, Panasonic in Japan, and LIDL in Europe and TORRAS in China, etc.

**主要展品 /Products**

迷你充电风扇, 加湿器, 电动牙刷, 洗手液, 暖风机, 风扇水杯

Mini rechargeable fan, mini humidifier, electric toothbrush, Automatic Soap Dispenser, Air Heater, Fan water bottle

**深圳市唯真电机发展有限公司****W2-2A10****Shenzhen Weizhen Motor Development Co., Ltd**

地址: 深圳市龙岗区坂田雪象中浩 2 路唯真工业园 (518129)

Add: Weizhen Industrial Park, Zhonghao 2 Road, Xuexiang, Bantian, Longgang, 518129, Shenzhen

电话 /Tel: 0755-33620888

传真 /Fax: 0755-33620001

网址 /Web: http://www.wzmotor.com.cn

深圳市唯真电机发展有限公司是开发和生产微特电机的专业厂家, 具有很强的技术开发能力和制造能力, 产品适用于汽车电子、办公家具、通讯设备、家用电器、医疗产品以及其它电子设备。公司本着真诚的服务和良好的信誉赢得了广大客户的认同和支持, 同时与国内外的供应商组成了紧密的利益共同体, 使公司步入了良性发展阶段、为实现唯真公司持续发展的战略目标打下了坚实的基础。

Shenzhen Weizhen Motor Development Co., Ltd. is a professional manufacturer to develop and produce DC micro & special motor. It has strong technique developing ability and manufacture capacity. Its products are applied to various kinds of video and visual equipments, office automation equipments, communication equipment, family electrical appliances, medical appliances, health care products, electronic toys and so on.

**主要展品 /Products**

微电机

Micro DC motor

CINO

**深圳市西啡科技有限公司**  
**Shenzhen CINO Technology Co., Ltd****N3-3B24 3B25**

地址: www.cino.com (518104)

电话 /Tel: 0755-29850162

西啡科技位于深圳, 是一家专业研发制造胶囊咖啡机的公司, 其产品出口 86 个国家和地区, 拥有 PCT 专利、发明专利、实用新型专利、软件著作权等合计 200 余项, 年产能达百万台

CINO Technology is located in Shenzhen, and is a company specializing in the development and manufacturing of capsule coffee machines. Its products are exported to 86 countries and regions. It has a total of more than 200 PCT patents, invention patents, utility model patents, software copyrights, and an annual production capacity of millions of units.

**主要展品 /Products**

盖亚商用胶囊咖啡机, 玛雅商用胶囊咖啡机, 萃十八



小泽医生

**深圳市小泽智能科技有限公司**  
**Shenzhen Xiaoze Intelligent Technology Co., Ltd****E3-3A10 3A11**

地址: 深圳市宝安区沙井街道大王山社区学岗泰丰工业区厂房 3 栋二层

电话 /Tel: 15010006400

网址 /Web: www.xiaozeyisheng.com

小泽医生是一家专注于清洁领域的科技家电品牌, 公司成员由一群技术与设计极客组成, 核心团队来自小米、京东、格力、歌尔声学等国内一线硬件与互联网厂商。致力于将更好的清洁技术转化为精致耐用的家电产品, 解决消费者在生活中遇到的各种清洁问题。品牌成立于 2019 年, 2020-2022 年超声波清洗机全渠道销量达 60 万台, 取得多项清洁相关专利, 同时与多所高校和科研单位保持密切的技术交流。

**主要展品 /Products**

超声波清洗机、超声波清洗机 PRO 杀菌版、超声波清洗杯 套装、果蔬净化器、隐形眼镜清洗盒 拂晓金 / 星月灰、超声波内裤清洗机

XinSPower

**深圳市新斯宝科技有限公司**  
**Shenzhen Xinspower Technology Co.,Ltd.****E1-1B26 1B27**

地址: 深圳市宝安区福永街道桥头社区福瑞路 11 号 (518101)

Add: Building 2, Xinhao Second Industrial Zone, Qiaotou Community, Fuhai Street,

Baoan District, Shenzhen

电话 /Tel: 13410183460

网址 /Web: www.xinspower.com

专注在开关电源适配器, 智能充电器, 电池充电器, 智能充电等标准电源产品及定制电源服务(ODM),

的开发, 制造和销售, 中国南部中型电源厂家之一; 有 12000sqm 制造工厂, 位于深圳宝安福永, 我们约有 500 名员工, 及 50 多名高水平管理和技术人员; 近年来一直通过战略性引进全自动化生产设备, 减少人工成本, 提高生产效率, 增强新斯宝电源适配器产品在市场上的价格竞争能力, 并通过自动化技术将质量更上一个层次;

Invested by XINSPower GROUP LIMITED, national High-tech enterprise, found in 2008, focus on power adaptor, smart charger, battery charger etc, standard power adaptor and customized power adaptor(ODM) development, manufacture and sale, it is one of the famous power supply factories in south China. Workshop scale reach 12000 sqm, located in Shajing Street, BaoAn, SZ (near expressway exit), with more than 500 skilled workers and 50 experienced management and technical personnel.

**主要展品 /Products**

电源适配器, 智能充电器, 氮化镓充电器, 电源适配器 6W 12W 24W 36W 48W 65W 100W 180W 240W 全球认证, 标准有 61558 家电, 62368IT/AV, 61347 台灯等

Adapter, smart charger, gallium nitride charger, power adapter 6W 12W 24W 36W 48W 65W 100W 180W 240W global certification, the standard includes 61558 household appliances, 62368IT/AV, 61347 desk lamps, etc.

**深圳市新泰合电器科技有限公司**  
**Homer Electrical Appliances Co., Ltd****N3-3B36 3B37**

地址: 深圳市龙华新区观澜大水坑桔坑路 35 号金奥工业科技园 (518109)

Add: Jin'ao Industrial Science and Technology Park, No.35 Jukeng Road, Dashuikeng,

Guanlan, Longhua New District, Shenzhen, Guangdong, China

电话 /Tel: 18127001810

传真 /Fax: 0755-23153271-816

网址 /Web: www.tagoo.com.cn

深圳市新泰合电器科技有限公司创立于 2005 年, 发展至今已有 10 余年, 是一家专业生产和出口厨房小家电产品的公司。优质的产品、合理的价格、完善的售后服务是我司的一贯宗旨, 所有产品均获得 GS, CE, EMC, ROHS, LFGB, REACH, UL/ETL, FCC 等认证。我厂拥有完善的生产设备和各种测试仪器, 从产品研发到批量生产, 严格把关, 对品质精益求精, 具有非常丰富的行业经验。

HOMER is a professional manufacturer and exporter of electrical household appliances over decade. We assure super-quality electric home appliances. All products get approvals of GS, CE, EMC, ROHS, LFGB, REACH, UL/ETL, FCC etc. Backed by high-grade engineers, with an intensive R&D department, we offer new products to keep up with market trends every year. It is essential to providing us a leading edge over our competitors. Our design laboratory is equipped with advanced engineering system and CAD/CAM facilities, which enable us to provide total solution to our customer covering design, tooling and manufacturing.

**主要展品 /Products**手提打蛋机, 带碗打蛋机, 手持搅拌棒, 台式搅拌机  
hand mixer, stand mixer, hand blender, table blender

**深圳市星合成科技有限公司****N4-4A47****SHENZHEN STAR SYNTHETIC TECHNOLOGY CO.,LTD**

地址: 广东省东莞市黄江镇金朗三街 21 号星合成分公司 (523749)

Add: No. 21, Jinlang 3rd Street, Huangjiang Town, Dongguan City, Guangdong Province

电话 /Tel: 0769-82555106

传真 /Fax: 0769-82555106

深圳市星合成科技有限公司是一家集设计研发、生产销售、服务和技术支持一体的功能性薄膜应用企业,产品广泛应用于家电、卫浴、电动自行车、服装、机械设备等行业。

公司的薄膜加热丝目前在家电行业应用累计已超过 8000 万片,各大主流整机厂商都有长期使用。

Shenzhen Star Synthetic Technology Co., Ltd. is a functional film application enterprise integrating design and development, production and sales, service and technical support, products are widely used in household appliances, bath, electric bicycles, clothing and electromechanical equipment. The company's film heating wire in the household appliances has been more than 80 million applications, the main manufacturers have long-term use of the household and similar electrical appliances.

**主要展品 /Products**

薄膜发热膜、薄膜开关、面板、薄膜传感器

flexible heater, membrane switch, flexible film pressure sensor

**深圳市雅贝康科技有限公司****W4-4B37****Shenzhen Yabeikang Technology Co., Ltd**

地址: 广东省深圳市宝安区沙井共和第三工业区 G 区 13 栋 (518100)

Add: Building 13, Zone G, Gonghe third industrial zone, Shajing, Bao'an District, Shenzhen,

Guangdong Province

电话 /Tel: 0755-23504389

网址 /Web: www.ybktech.com

公司始创于 2010 年,致力打造口腔护理健康产品。荣获国家高新企业和 BSCI、ISO 国际质量体系认证,研发产品获得 150 多项全球国家地区的技术专利。工厂占地占积达 10820 平方,320 余生产人员,研发 20 余人。拥有产品研发 模具设计、注塑成型、无铜植毛加工、生产组装、市场销售等国内电动牙刷行业前三的大型一站式企业。

Founded in 2010, the company is committed to creating oral health care products. It has won the national high-tech enterprise and BSCI and ISO international quality system certification, and its R & D products have won more than 150 technical patents in countries and regions around the world. The factory covers an area of 10820 square meters, with more than 320 production personnel and more than 20 R & D personnel. It has the top three large one-stop enterprises in the domestic electric toothbrush industry, such as product R & D, mold design, injection molding, copper free hair planting processing, production and assembly, market sales and so on.

**主要展品 /Products**

冲牙器、电动牙刷、无铜刷头

oral irrigator, Electric toothbrush, Copper free brush head

**深圳市雅蔓谷化妆品有限公司****E3-3C86****Shenzhen Yaman Valley Cosmetics Co., LTD**

地址: 宝安区凤塘大道 164 号 (518128)

Add: 164 Fengtang Avenue, Bao'an District, Shenzhen

电话 /Tel: 13798358583

<https://shop944129797f037.1688.com/?spm=a261y.7663282.autotrace-topNav.1.102362f5xcQx9B>

美时美刻是业界知名的医疗级家用美容仪器供应链平台,多年来深耕于美容高科技产品的研发和市场推广,拥有强大的技术研发能力和先进的产业供应链基地,赋能和服务过众多的全球知名家用美容仪器品牌,近年专注于医疗级家用脱毛仪、美容仪领域。

Meishi Meeco is a well-known supply chain platform of medical grade home beauty instrument for many years. Cultivates in the beauty high-tech product research and development and the market promotion, has the strong technical research and development ability. And advanced industrial supply chain base, enabling and serving many of the world's famous household beauty Instrument brand, in recent years, focusing on medical household hair removal instrument, beauty instrument field.

**主要展品 /Products**

脱毛仪

Hair removal instrument

**深圳市言九电子科技有限公司**  
**YJ POWER GROUP LIMITED****E3-3A33 3A34**

地址: 东莞市长安镇复兴路 35 号

电话 /Tel: 13480935393

传真 /Fax: YJ POWER GROUP LIMITED

网址 /Web: www.yjbattery.com

深圳市言九电子科技有限公司是一家从事锂电池研发、生产、销售的国家级高新技术企业,并荣获了“国家级专精特新”企业称号。分别在东莞长安、江西宜春建有生产基地,总建筑面积达 25000 m<sup>2</sup>。

公司产品有聚合物锂电池、圆柱型锂电池、微型号锂电池、串并联锂电池。应用于智能家居、智能穿戴、仪器仪表、医疗健康、军警设备等诸多电子产品领域。产品通过了 UL、CB、KC、PSE、CQC 等相关认证。

YJ Power Group Limited is a state-level high-tech enterprise engaged in the research and development, production and sales of lithium batteries, and has won the title of "Specialized and Specialized New" enterprise. Our production bases separately in Chang'an, Dongguan, and

Yichun, Jiangxi, with a total construction area of 25,000 square meters.

The company's products include polymer lithium batteries, cylindrical lithium batteries, micro-model lithium batteries, and series-parallel lithium batteries. Widely used in many electronic product fields such as smart home, smart wear, instrumentation, medical health, military and police equipment.

#### 主要展品 /Products

公司产品有聚合物锂电池、圆柱型锂电池、微型号锂电池、串并联锂电池。

The company's products include polymer lithium batteries, cylindrical lithium batteries, micro-model lithium batteries, and series-parallel lithium batteries.



#### 深圳市壹海智能有限公司 Shenzhen Yaohai Intelligent Co., Ltd

W3-3B30

地址: 深圳市宝安区福海街道凤塘大道 50 号 (518104)

Add: No. 50, Fengtang Avenue, Fuhai Street, Bao'an District, Shenzhen

电话 /Tel: 13410280734

传真 /Fax: 0755-27417250

网址 /Web: <http://szyaohai.com/>

深圳市壹海智能公司是一家专注于清洁类智能家电产品的技术开发及大规模智能制造的公司, 以“推出高性价比产品, 让生活更美好有趣”为公司使命。重点以定制化方案开发为立足点, 致力于成为“为客户提供风靡全球产品”的 ODM 企业。

公司主要以设计开发为强项立足, 现有研发人员 20 人, 曾服务于小米、莱克、海康威视、海尔等品牌商项目, 出货量超过 100W 台。具备大批量设计和生产的经验, 可以为客户提供最为稳定的批量产品。

Yaohai is a high-tech company which focuses on the technology development and large-scale intelligent manufacture of cleaning intelligent household appliances.

Focus on customized solution development as a foothold, committed to become "to provide customers with popular global products" ODM enterprises.

Yaohai owns R&D Centers in SZ, China. The team has developed and sold as many as 1m of them. Self-developed Solutions & Fully support customers' continuous development.

#### 主要展品 /Products

扫地机器人 / 手持洗地机 / 清洁电器 / 电动类智能家电

Sweeping robot/hand-held floor washer/cleaning appliances/electric smart appliances

## ONEJ 壹洁

### 深圳市壹洁智能科技有限公司 Shenzhen ONEJ Technology Co., Ltd.

W3-3A35

地址: 广东省深圳市宝安区新桥街道汇聚新桥 107 创智园 B 座 B309 (518125)

Add: B309, ChuangZhiYuan, HuiJuXinQiao 107, 18th ShangLiao Industrial RD., XinQiao Str., Bao'An Dist., Shenzhen, China 518125

电话 /Tel: 0755-23577194

传真 /Fax: 0755-27417363

网址 /Web: [www.onejtech.com](http://www.onejtech.com)

深圳市壹洁智能科技有限公司, 成立于 2020 年 12 月。是一家集研发, 生产, 销售于一体的专业 OEM/ODM 厂商。产品包括擦窗机器人, 扫地机器人, 洗地机, 挂脖风扇, 布艺清洗机等。公司以自主研发的擦窗机器人为核心, 扫地机和其他智能家居产品为辅, 依托国内外销售的成功经验, 打造新型智能家居清洁用品企业。自成立以来, 壹洁已形成研发、国内外销售、综合管理、供应链管理等数十个团队, 申请专利 40 多项。

Shenzhen ONEJ Technology Co., Ltd was established on December 30th, 2020. It is a high-tech enterprise integrating R&D, manufacture and sales of various types of vacuum cleaner products such as Window Cleaner Robot, Vacuum Cleaner Robot and Cordless Wet & Dry Vacuum Cleaner.

The company takes the self-developed window cleaner robot as the core, vacuum cleaner robot and the window cleaning robot as the supplement, and other ODM smart home products, relying on the successful experience of domestic online sales and overseas ODM sales, to create a new smart home cleaning products enterprise.

Since its establishment, ONEJ has formed dozens of teams including R&D, domestic and foreign sales, comprehensive management, and supply chain, of which the R&D team accounts for nearly half, and has applied for more than 40 patents.

#### 主要展品 /Products

智能擦窗机器人、智能扫地机器人、智能洗地机器人、手持洗地机

Intelligent Window Cleaning Robot, Intelligent Robot Vacuum Cleaner, Intelligent Floor Mopping Robot Cleaner, Cordless Wet & Dry Vacuum Cleaner



宜居云

### 深圳市宜居云科技有限公司

N3-3C91

地址: 深圳市宝安区新安街道兴东社区 69 区洪浪北二路 30 号信义领御研发中心 1 栋 2605

电话 /Tel: 0755-86183326

网址 /Web: <http://egscript-test.eg-cloud.com>

宜居云成立于 2015 年, 主要专注于物联网技术应用, AIOT 开发和云服务平台服务, 提供一站式人工智能物联网解决方案, 致力于打造有优质的数字化服务平台。

宜居云经过对上下游的资源整合, 形成完整的物联网开发服务生态, 通过技术衔接和运营整合, 有效撮合了开发者与需求企业合作、降低了供应商和用户交易成本, 通过第三方接口源源不断释放共享经济的巨大价值, 参与到应用分成, 达成生态共赢。

Established in 2015, YIJUYUN mainly focuses on the application of Internet of things technology,



AIOT development and cloud service platform services, provides one-stop artificial intelligence internet of things solutions, and is committed to building a high-quality digital service platform. Through the integration of upstream and downstream resources, livable cloud forms a complete Internet of things development service ecosystem. Through technical connection and operation integration, it effectively matches the cooperation between developers and demand enterprises, reduces the transaction costs of suppliers and users, continuously releases the great value of sharing economy through third-party interfaces, participates in application sharing, and achieves ecological win-win results.

#### 主要展品 /Products

- 1.面包机: 家用小型全自动多功能面包机,一键设置烘焙美味面包,懒人式面包机,智能操作,WIFI面包机,支持众多云食谱,一日三餐不重样。
- 2.牛排机: 全自动多功能牛排机,两分钟吃上牛排,双面加热,智能预热程序,自动恒温管控,防倾倒设计,烹饪更安全。
- 3.宜休健康精灵: 卧室健康精灵,智能健康睡眠管家,重新定义亿万家庭睡眠健康,睡眠健康检测,缓解心率监测,智能灯光音响,非穿戴,无接触式实时监测。

1. Bread machine: household small automatic multifunctional bread machine, one key setting, baking delicious bread, lazy bread machine, intelligent operation, WiFi bread machine, supporting many cloud recipes, three meals a day are not heavy.
2. Steak machine: fully automatic multifunctional steak machine, two minute steak, double-sided heating, intelligent preheating program, automatic constant temperature control, anti dumping design, safer cooking.
3. Yixiu health spirit: bedroom health spirit, intelligent healthy sleep housekeeper, redefine hundreds of millions of families' sleep health, sleep health detection, ease heart rate monitoring, intelligent lighting and sound, non-wear, non-contact real-time monitoring

#### 深圳市英维克健康环境科技有限公司

#### Shenzhen Envicoal Health Environment Technology Co.,Ltd.

地址: 深圳市龙华区观澜街道观光路 1303 号鸿信科技园 5 栋

Add: B4th floor, Building 5, Hongxin Industrial Park, Guanlan Longhua, District, Shenzhen China

电话 /Tel: 0755-23772306

网址 /Web: www.ebcair.com

深圳市英维克健康环境科技有限公司是一家致力于人居空气环境综合治理和管控,集研发、生产、销售于一体的高科技企业。产品线包括“空气环境机”、“空气消毒净化机”、“空气新风消毒机”、“空气消毒净化组件”。产品广泛应用到家庭、学校、体育馆、医院、商场等室内场所;并为电梯、公交、客车、地铁、商业建筑中央空调系统等特殊环境的空气消毒和改造服务提供解决方案。

We focus on providing clean air environment unit for various area, including house, classroom, hospital, stadium, etc.

EBC series products have been very popular since release, widely applied in dozens of province and cities, like Shenzhen, Beijing, Guangdong, Fujian, Zhejiang, Jiangsu, etc.

W2-2H61

We devote a lot in R&D research, taking customer's need as priority, working together with partners and providing reliable and competitive products.

#### 主要展品 /Products

EBC 空气环境机,是把影响室内空气环境的几大要素(温度、湿度、含氧量、颗粒物污染、微生物污染、异味)集成于一机进行综合调控的产品。通过高精度传感器实时监测空气质量,反馈到 AI 控制中心运算,独创 EMPC 多维相控技术,调动温控、新风、空气消毒、空气净化模块联动运行,根据现场时刻输出最适宜的温、湿、净、氧,最终实现一机智控全屋空气环境。

With original multi-dimensional phase control technology,EBC air environment unit can monitor and control temperature, humidity, CO2, formaldehyde, PM2.5, TVOC and other dimensions of air quality indicators in real time, so the indoor air environment is always at an excellent level.

#### 盈源电源

#### 深圳市盈源电子有限公司

#### Shenzhen shi Yingyuan Electronics Co.,Ltd

地址: 深圳市宝安区西乡街道九围社区鸿业工业园 8 栋 7 楼西 (518126)

Add: The 8th Building,Hongye Industrial Zone,Jiuwei village Xixiang,Baoan District,Shenzhen,China

电话 /Tel: 13926528767

传真 /Fax: 0755-29875684

网址 /Web: www.szyingyuan.com.cn

W4-4A10 4A11

深圳市盈源电子成立于 2006 年,坐落于深圳,是一家从事开发生生产和销售电源适配器充电器的的高新技术型企业。拥有独立工业园于广东惠州,占地 30 亩,建筑面积 6 万平,员工总数约 1100 人,月产能 300 万套,年营业额大约 5 亿 RMB,产品范围从 5W-180W 电源适配器,100W 到 3600W 充电器。已通过全球安全认证及多项环保认证并取得了多个实用的创新及发明专利。

Shenzhen Yingyuan Electronics, founded in 2006 and located in Shenzhen, is a high-tech enterprise engaged in the development, production and sales of power adapter chargers. It has an independent industrial park covering an area of 30 mu, a building area of 60000 square meters, a total of 1100 employees, a monthly production capacity of 3.0 million sets, an annual turnover of about 500 million RMB, and a product range from 5W-180W power adapter 100W to 3600W charger. It has passed the global safety certification and a number of environmental protection certification, and has obtained a number of practical innovation and invention patents.

#### 主要展品 /Products

电源适配器 /PD 充电器 / 电池充电器

Power adapter /PD Charger/Battery charger



**深圳市永诚创科技有限公司**  
**Shenzhen YCCFAN Technology Co., Ltd.**

**W2-2B03**

地址: 深圳市宝安区沙井街道南浦路东环工业区 A1 栋 (518125)  
电话 /Tel: 86-755-29887126-27  
传真 /Fax: 86-755-29887129  
网址 /Web: www.yccfan.com

永诚创科技于 2006 年在中国深圳成立, 自成立以来, 公司一直专注于散热风扇的研发、生产与销售, 致力于成为中国散热风扇行业第一品牌。

经过永诚创人多年来的不懈努力, 公司已拥有完善的产品研发与生产系统, 包括: 信赖性实验室、噪音实验室、风量风压测试设备、高精密度平衡设备及自主开发的计算机智能生产管理系统等; 同时, 公司通过并严格按 ISO9001 及 ISO14001 管理体系进行生产作业, 实现了每日 30,000 颗

YCCFAN was founded in 2011 and located in Shenzhen of China. Since we established, we are always focusing on the R&D, production and selling the cooling fans, and committed to becoming the top brand in Chinese cooling fan industry. Now, we have the independent plant with 230,000m<sup>2</sup>, 600 staffs, daily production capacity more than 210,000 pieces. We had built the complete product R&D and production system, such as: Reliability Laboratory, Noise Testing Room, Air Flow & Pressure Testing Chamber, Mold Manufacturing, Plastic Injection, Auto-Production and Auto-Inspection; meanwhile, we passed and manage company with the ISO9001, ISO14001 and IATF16949.

**主要展品 /Products**

DC 直流风扇 20~200mm  
AC 交流风扇 80~250mm  
EC 风扇 60~200mm  
DC Fan 20~200mm  
AC Fan 80~250mm  
EC fan 60~200mm



**深圳市优奕视界有限公司**  
**SHENZHEN VIEWE TECHNOLOGY CO.LTD**

**W4-4B44**

地址: 深圳市宝安区华丰第一科技园 A 区茶树 B 栋 8 楼 (518100)  
Add: 8 / F, building B, tea tree, zone a, Huafeng first science and Technology Park,  
Bao'an District, Shenzhen  
电话 /Tel: 18822829767  
传真 /Fax: 0755-29432299  
网址 /Web: www.chinasunye.com

优奕视界专注于类工控触控显示一体化解决方案及智能人机交互应用, 是一家集研发、生产、销售为一体的国家级高新技术企业。公司秉承专业、敬业、创新、明志的核心价值观, 以客户为中心, 创新驱动, 立志成为最具价值, 受人尊敬的显示交互领域领先企业。

VIEWE Focusing on industrial control touch display integrated solutions and intelligent human-

computer interaction applications, it is a national high-tech enterprise integrating R & D, production and sales. Adhering to the core values of professionalism, dedication, innovation and ambition, the company is customer-centered and innovation driven, and is determined to become the most valuable and respected leading enterprise in the field of display interaction.

**主要展品 /Products**

液晶显示触摸屏及一体化解决方案  
智能人机交互应用

## 裕欣源

**深圳市裕欣源电子科技有限公司**  
**Shenzhen Yuxinyuan Electronic Technology Co., Ltd**

**E3-3B31 3B32**

地址: 深圳市龙华区观澜街道库坑社区同富裕工业区 28 号华朗嘉工业区 2 栋 301 (518110)  
Add: 301 No.2 Hualangjia Industrial Park No.28 Tongfuyu Industrial Area Kukeng Community  
Guanlan Street Longhua District Shenzhen  
电话 /Tel: 075523736847  
传真 /Fax: 075523736847  
网址 /Web: www.yuxinyuansz.com

深圳市裕欣源电子科技有限公司坐落于深圳龙华新区毗邻深圳北站, 厂方面积 5500 平方米, 是一家集研发、生产、销售、营销为一体的高新技术企业, 公司专注于个人护理类产品口腔清洗器鼻腔冲洗器等。公司已经通过了 ISO9001:2015 质量管理体系认证, 通过 ISO13485:2016 医疗器械质量管理体系认证, BSCI 认证, 产品通过了专业和权威机构进行的 ROHS, CE, FDA, FCC, IPX7 的检测与认证。

Shenzhen Yuxinyuan Electronic Technology Co., Ltd is located in Longhua New District, Shenzhen near Shenzhen North Railway Station. The factory area is 5500 square meters which is a high-tech enterprise incorporating research and development, manufacture, as well as sales and marketing activities. Yuxinyuan specializes in personal care products: oral irrigators, nasal irrigators and so on. The company has passed ISO9001: 2015 quality management system certification and ISO13485:2016 medical device quality management system certification, BSCI certification. The products have passed the ROHS, CE, FDA, FCC IPX7 testing and certification conducted by professional and authoritative institutions.

**主要展品 /Products**

冲牙器  
oral irrigator, water flosser



**深圳市云中飞电子有限公司**  
**VVFly Electronics Co., Ltd.**

**W3-3A47**

地址: 广东省深圳市南山区科技园  
电话 /Tel: 152220180146

云中飞成立于 2014 年, 是专注于智能硬件、大数据服务平台以及将人工智能技术应用于改善睡眠的国家高新技术企业, 致力于用科技与创新力帮助人们拥有优质睡眠, 筑造健康生活。

旗下呼噜圈全力发展智能止鼾应用领域的创新, 凭借先进的技术和深刻的用户需求洞察, 拥有全球首创物理微干预止鼾技术的发明专利, 开创眼部、耳部、喉部的便捷式人工智能止鼾系列产品和助眠系列产品。销售遍及欧美、日韩和港澳台等 40 多个国家和地区。

Founded on December 31, 2014, VVFLY Electronics Co., Ltd. is a Chinese high-tech enterprise specializing in the application of intelligent hardware, big data, and artificial intelligence technology to human sleep.

By conducting in-depth research into snoring, sleep apnea, hypoventilation, and other sleep-related breathing disorders, VVFLY has made continuous breakthroughs in the development of intelligent anti-snoring products and treatment of obstructive sleep apnea-hypopnea syndrome (OSAHS).

#### 主要展品 /Products

通过先进的声音识别和骨传导技术, 对用户的鼾声和打鼾时引起的脑骨振动进行数字信号处理, 自动匹配振动或低频脉冲刺激模式, 实施由弱到强的物理干预, 使咽喉部肌肉收缩, 打开呼吸道, 让用户在不影响睡眠情况下停止或减少打鼾。



#### 深圳市中科世纪科技有限公司

#### Shenzhen Zhongke Century Technology Co., Ltd.

N1-1A21

地址: 深圳宝安区福海街道新田社区大洋路 99-2-401 (518100)

Add: 99-2-401, Dayang Road, Xintian community, Fuhai Street, Bao'an District, Shenzhen

电话 /Tel: 18929352713

传真 /Fax: 075527811571

网址 /Web: www.zksjpump.cn/www.zks.com

本公司成立于 2009 年, 专业研发、设计、生产汽车电子水泵, 医疗水泵, 散热循环特种工业水泵, 无刷直流水泵, 磁力泵, 三相直流水泵, 太阳能水泵, 无刷直流变频水泵, 公司位于电子之都, 创意之都, 设计之都 -- 深圳! 毗邻深圳国际机场, 广深高速, 交通便利。依托深圳强大的生产研发和设计实力以及深圳得天独厚的人才优势, 坚持好水泵 中国造的优良品质。公司目前是中国专业的无刷直流磁力隔离泵生产厂家。

Established in 2009, Shenzhen Zhongke Century Technology Co., Ltd in the leading and biggest manufacture specializing in ECO car circulation pumps, medical pumps, special industrial heat circulating pumps, brushless DC pumps, magnetic pumps, three-phase direct current pumps, solar water pumps, Brushless DC inverter pump in china.

Our Company is located in the electronic and design capital- Shenzhen! Relying on Shenzhen strong production R & D strength and Shenzhen unique talent advantage, to create a first-class quality products. our company is currently China's most professional brushless DC magnetic isolation pump manufacturers. Has a complete quality assurance system, we have passed the ISO9000 and other international quality system certification, with a number of patented technology.

#### 主要展品 /Products

无刷直流水泵; 太阳能水泵; 微型潜水泵; 微型喷泉水泵; 直流鱼缸循环泵; 微型热水循环泵; 汽车循环泵; 微型油泵; 采暖床垫泵; 直流造浪泵; 直流变频潜水泵; 直流变频上水泵。

Brushless DC water pump; solar water pump; micro submersible pump; micro fountain water pump; DC fish tank circulating pump; micro hot water circulating pump; automobile circulating pump; micro oil pump; heating and cooling mattress pump; DC wave-making pump; DC frequency conversion submersible pump.

#### Lei non electric aroma diffuser

#### 深圳市妆主科技有限公司

E3-3C83

地址: 深圳市宝安区西乡街道臣田社区臣田工业区 34 栋 5 层 511

电话 /Tel: 13602522877

妆主公司的新型芳香加湿器 Lei 已取得发明专利。并相继获得世界三大设计奖 [Red Dot Award 2021](设计奖)及 [iF Design Award 2021](iF 设计奖), 另外获得代表意大利设计奖 [A'Design Award](A 设计奖) 的银奖。

#### 主要展品 /Products

这款精油扩香仪的使用方法很简单, 只要先点燃蜡烛、放上玻璃盖, 接著将喜欢的精油放入小盘中, 装入风车后方的装置, 静待 3 到 4 分钟之后, 就可以用手指顺时针转动扇翼, 吹出美好的精油香气, 让味道在空间中缓缓释放。整个过程中不用任何电力, 没有缠人的电线, Lei 可以摆放在任何想要的位置, 不管是客厅、餐厅、房间、浴室或办公室, 都能发挥强大功效。



#### 深圳玩智商科技有限公司

#### Shenzhen EAI Technology Co., Ltd.

E1-1B35

地址: 广东省深圳市南山区打石一路国际创新谷 7 栋 A 座 16 楼 (518000)

Add: 16th Floor, Block 7A, International innovation Valley, Nanshan District, Shenzhen, Guangdong, China.

电话 /Tel: 0755-86540131

传真 /Fax: 0755-86540131

网址 /Web: www.ydlidar.cn

深圳玩智商科技有限公司 (简称“EAI 科技”) 是一家专注于智能传感器及解决方案的国家高新技术企业。EAI 科技在深圳设立研发总部, 并在武汉设立研究所, 目前已在仲恺国家高新区建设 EAI 科技园。EAI 科技自主品牌 YDLIDAR 涵盖了三角、ToF 等多个原理品类的激光雷达产品, 应用覆盖了扫地机器人、服务机器人、数字多媒体互动、工业自动化等多个领域, 已服务了国内外 40+ 个国家及地区, 200+ 个企事业单位及院校。

Shenzhen EAI Technology Co., Ltd. ("EAI Technology" for short) was established in 2015. It is a national high-tech enterprise focusing on intelligent sensors and solutions. EAI Technology Research and Development Headquarters is located in Shenzhen, and has research institutes in Wuhan. In 2021, EAI Science and Technology Park located in Huizhou ZhongKai National High-tech Zone. EAI technology product category covers the triangle, ToF and other principles categories of lidar products, with independent brand YDLIDAR. Its applications cover a wide range of fields such as robot vacuum cleaners, service robots, digital multimedia interactions, industrial automation, intelligent security and intelligent transportation. Enterprises serve more than 40 countries and regions, more than 200 enterprises and institutions.

**主要展品 /Products**

EAI 科技专注智能传感器及其解决方案的研发创新,以促进人工智能产品商业化应用为驱动,并进一步通过树立标杆案例,实现了解决方案纵横规模化复制至多种传感器及多类人工智能产品。激光雷达是一种采用非接触激光测距技术的扫描式传感器,该产品通过在实际应用场景进行激光扫描,产生扫描环境的平面点云图信息,进而为智能移动设备实现导航避障功能。旗下激光雷达品牌 YDLIDAR 已广泛应用于消费级,商用级,工业级等应用场景。

EAI focuses on the R&D of intelligent sensors and related solutions, driven by the purpose of promoting the commercial application of artificial intelligence products. EAI has established many benchmark cases to realize the large-scale replication of solutions to a variety of sensors and a variety of artificial intelligence products. LiDAR is a scanning sensor using non-contact laser ranging technology. Through laser scanning in the application scene, LiDAR generates plane point cloud map information of the scanned environment, and then realizes the functions of navigation and obstacle avoidance for intelligent mobile devices. YDLIDAR, the flagship brand of LiDAR from EAI, has wonderful market performance and has been widely used in consumer, commercial, and industrial application scenarios.



INXNI 以内

**深圳以内创新科技有限公司****Shenzhen Inxni Innovation Technology Co., Ltd**

地址: 广东省深圳市龙华区银星智界一期 2 号楼 17 层 (518110)

Add: Floor 17, Building 2, First-stage of Silver Star Intelligent World, Guanlan Street, Longhua New District, Shenzhen, Guangdong, China

电话 /Tel: 0755-36887699

传真 /Fax: 0755-36887699

网址 /Web: www.silverstar-robot.com

INXNI 以内是一家探索家庭服务机器人未来的公司,拥有全屋智能机器人和宠物智能机器人两大业务版块。品牌成立于 2022 年 3 月,由银星智能集团全资投入——2021 年全球 ODM 出货第一。10 月携知名音乐创作者 / 歌手蔡徐坤为 INXNI 以内品牌代言人,双 11 一举成为天猫清洁电器新品第一。拥有服务机器人行业先进的 SLAM 算法、AI 识别、IOT、云平台应用等技术,及全球优选供应链体系与国际标准的智造实力。

INXNI is a company focuses on exploring the future of home service robots industry with two major categories: the entire house intelligent robots and pet intelligent robots.

The brand was established in March 2022, 100% invested by Silver Star Intelligence Group –with the world's largest ODM business for robot in 2021.

In October, Mr Cai Xu Kun, one of the most famous Chinese music creator/singer, became the brand spokesperson of INXNI.

INXNI also became the Top1 new cleaning appliance brand on Tmall on Nov 11. It equipped advanced SLAM algorithm, AI identification, IOT, cloud platform application and other technologies in the home robot industry, as well as the global optimized supply chain system and international standards of intelligent manufacturing strength.

**主要展品 /Products**

家庭服务机器人

home service robot

**E1-1H31****深圳智美电器股份有限公司****Iconbeauty (Shenzhen) Holding Ltd.**

地址: 广东省深圳市光明区松柏路 7002 号埃迪蒙托工业园 C 栋 7 楼

Add: 7/F, Block C, Idee Monto Industry Park, No.7002 Songbai Road, Guangming District, Shenzhen, China

电话 /Tel: 18688993418

网址 /Web: www.iconbeauty-care.com

深圳智美电器股份有限公司成立于 2017 年,专注于声波电动牙刷、冲牙器等口腔护理产品的研发、生产和销售的国家高新技术企业,严格执行 ISO9001, ISO13485 质量管理体系和 ISO14001 环境管理系列标准和 BSCI 认证。

所有产品获得 CCC, CE, FCC, FDA, KC, IPX7, ETL 等认证,并获得多项发明专利,实用新型专利和外观设计专利。

产品主销欧美,俄罗斯等 30 多个国家和地区。

Iconbeauty (Shenzhen) Holding Ltd. (Iconbeauty) was established 2017 and now becomes a professional manufacturer of oral care products. As a National High-Tech Enterprise, we focus on developing, manufacturing and marketing of sonic electric toothbrush, water flosser, UV sterilizer and tooth whitening device.

Iconbeauty strictly operates a quality management system that complies with all requirements of ISO9001, ISO14000 and ISO 13485-2016. We have been qualified by BSCI and certified with CCC, CE, ROHS, FCC, FDA, KC, IPX7, ETL...etc. Meanwhile, we hold plenty of technology and invention patents. Our products have been exported over 30 countries including USA, Canada, Japan, Korea, Great Britain, France, Germany, Spain and Russia...etc.

Iconbeauty promotes smart lifestyles for families by providing high quality personal care products, and committed to the philosophy of unremitting pursuits of excellence and continuously contributing to the wellness of people around the globe.

**主要展品 /Products**

声波电动牙刷、冲牙器(水牙线) 紫外线消毒器和牙齿美白仪等口腔护理产品

Sonic electric toothbrush, Water flosser, UV sterilizer and tooth whitening device

**圣戈班高性能塑料(上海)有限公司****Saint-Gobain Performance Plastics(Shanghai) Co., Ltd.**

地址: 上海市闵行区昆阳路 1476 号 (200245)

Add: 1476 Kunyang Road, Minhang District, Shanghai

电话 /Tel: 02154721568

传真 /Fax: 02154721568

网址 /Web: www.plastics.saint-gobain.com.cn

圣戈班高性能塑料公司设计和生产高性能聚合物工程产品,服务于全球几乎所有主要行业。我们的各项业务为客户提供具有先进技术的聚合物产品,满足苛刻的应用条件,为各大关键行业提供支持。圣戈班高性能塑料公司以根植于产品创新、技术专长的传统为豪,致力于与客户紧密合作,解决当前的

**E3-3C82****W1-1B43**



应用问题以及未来所面临的挑战。

主要展品 / Products

蠕动泵软管



**勝得榮**  
國際股份有限公司

**勝得榮國際股份有限公司**  
**Sandalphon International Inc.**

**N1-1B22**

地址: 台湾, 台南市东区庄敬路 136 巷 13 号 (701026)

电话 /Tel: 8866-2093126

网址 /Web: <https://sandalphon.com.tw/>

勝得榮名字源自于生命智慧的大天使 -Sandalphon 守护地球上丰饶、美丽、力量与生命。家 - 是社会根本, 勝得榮最呵护的种子, 博士团队在研发之初, 选择能为自己家人与更多家庭改变的方向, 从生物晶片、物质讯息波、低频磁场等技术, 开创属于频率科技的全新领域, 以科技处理现代科技产生的困扰, 协助人们恢复内外在平衡。截至今已协助上万个家庭透过睡眠改善, 大幅提升生活品质, 延续勝得榮的初衷“守护家人与家庭健康”。

主要展品 / Products

自然睡眠、原生科技、共同创造生命品质

睡眠扑满为全台湾首创 `独家 SFT 频率晶片+舒曼波原生频率`, 以高科技、零接触、零干扰, 协助改善睡眠困扰, 透过导引频率共振, 导正身体原本偏差的状态, 协助延长深睡期, 提升睡眠品质, 进而恢复内外在的平衡。



**胜业电气股份有限公司**  
**Sheng Ye Electric Co., Ltd**

**W3-3B26**

地址: 广东省佛山市顺德区伦教街道薰涌新薰四路北 4 号 (528309)

Add: NO.4, Xinxu 4th Road, Shun de Foshan City, Guang dong Province

电话 /Tel: 0757-27830196

传真 /Fax: 0757-27837097

网址 /Web: [www.shengye.com](http://www.shengye.com)

胜业电气始建于 1996 年, 属国家高新技术企业, 是一家大型专业薄膜电容及相关电子元件制造企业。建面 5 万平方米, 员工 8 百多人, 拥有 50 余项国家专利。公司先后通过了各类体系认证, 产品通过美国 UL、中国 CQC、德国 DVE、TUV 及加拿大 CSA 等质量认证。产品 70% 远销欧美, 年销售额达 4 亿多元。已与美国通用电气、美国惠而浦、美国雷诺士、意大利沃尔泰、新西兰 ABB 电气、艾默生电气等多家国际知名企业建立合作。

ShengYe Electrical Co.,Ltd was established in 1996, an ISO9001 approved enterprise, one of the National High Technology Enterprises, specialized in R&D, manufacture, sales and after-sale service of film capacitors and other electrical elements. The New factory covers more than 50 thousands square meters, with more than 800 skillful workers. Our products have got over 40

patents and international certificates of UL\ CQC\ VDE\ TUV\ CSA.

Our products are sold to North America, Europe, Southeast Asia, Australia and other oversea markets by 70%; annual turnover reaches USD 70 millions. Through years of hardworking, we have earned customers' trust and reputation. Now we have become strategic partners with GE\ WHIRLPOOL\ LENNOX\ VORTICE\ ABB (NEW ZEALAND)\ EMERSON, ETC.

主要展品 / Products

家用电器、工业电机、灯具补偿类电容器

## SEVERIN

**施威朗电器 (深圳) 有限公司**  
**Severin Electric Appliance (Shenzhen) Co., Ltd.**

**N3-3H76**

地址: 深圳市宝安区沙井街道步涌社区第八工业区蚝一股份合作公司工业园 4 栋二层

电话 /Tel: 0755-88215381

130 年来,

SEVERIN

施威朗,

一直是值得信赖与创新的代名词:

从产品设计与开发, 到材料选择与加工,

始终坚守真正的德国品质,

为每个追求设计感与高品质生活的现代家庭提供操作简单、性能卓越的电器。

主要展品 / Products

咖啡机, 烧烤机, 酸奶机, 冰淇淋机, 煮蛋器等



**仕达利恩 (惠州) 电子有限公司**  
**STARION (H.Z)ELECTRONICS CO.,LTD**

**W4-4B20**

地址: 惠州市惠阳区镇隆镇联溪村粉石坳村民小组地段 (二期) 厂房 F, G, 宿舍, 设备房, 值班室 (516227)

Add: LIANXI, ZHENLONG TOWN, HUIZHOU CITY, GUANGDONG PROVINCE, CHINA

电话 /Tel: 0752-3767720

传真 /Fax: 86-752-376-7730

网址 /Web: <http://switch.starion.co.kr>

STARION 是仕达利恩开发和生产的产品综合品牌, 具有不断努力创新的进取意识, 以先进的尖端技术生产与生活紧密相关的产品。销售量是全球最大的仕达利恩大微动开关, 源自韩国的技术, 开发生产 25 年的历史, 来自韩国全自动化设备 (全自动化生产全自动化检测) 完善的全球安规认证。仕达利恩将积极扩展销售渠道, 增加销售额, 并竭诚与顾客建立亲密友好关系。

STARION is a STARION's integrated brand name as well as the corporate name of its sales & marketing company. STARION is keen on developing customer-focused products. As new materials from space are close to be becoming a feasible alternative to earth-based materials, STARION (STAR+IRON) promises to be the launch pad for a better future.

STARION will strengthen the quality-focused management infrastructure by bolstering

professional service with its highly qualified staffs. Significantly reinforcing its marketing and advertising programs, STARION will become a globally friendly brand image.

#### 主要展品 /Products

大微动开关、小微动开关、干簧管开关、防倾倒开关。  
MicroSwitch、smallswitch、Reed Switch、Tilt Switch



#### 舒乐氏 SoleusAir

W2-2F61

地址：广东省佛山市顺德区大良街道北区社区绿田路12号A栋3层304号（仅作办公用途）  
电话 /Tel: 0757-22284301  
网址 /Web: <https://www.soleusair.net.cn/>

SoleusAir, 美国最受欢迎的高端家电品牌之一, 始创于1997年。SoleusAir 始终严格把控每个生产环节, 把匠心品质和服务推向全世界, 目前已覆盖16个国家地区, 服务超过1000万+家庭, 已成为全球性家电品牌。2019年SoleusAir 进入中国市场, 品牌中文名定位“舒乐氏”, 调研和分析中国市场用户需求, 陆续推出空气净化器、加湿器等明星产品, 如今已成为中国市场环境电器领军品牌之一。

#### 主要展品 /Products

SoleusAir 舒乐氏以守护家庭呼吸健康为核心, 聚焦都市品质家居, 产品基本覆盖家庭日常使用场景, 涵盖生活家电、清洁、衣护三大品类, 其中舒乐氏空气净化器、空气消毒机、加湿器、洗地机、衣物护理机等明星产品深受用户喜爱, 舒乐氏坚持打造兼具行业差异化与高端品质的创新产品, 全方位打造家居健康生态。



#### 思必驰科技股份有限公司 AI Speech Co., Ltd.

W3-3E71

地址：中国（江苏）自由贸易试验区苏州片区苏州工业园区新平街388号腾飞科技园14幢（215000）  
Add: No. 14 Building, Ascendas iHub Suzhou, No. 388 Xinping Street Suzhou, 215021 China  
电话 /Tel: 0512-62997990  
传真 /Fax: 0512-62997990  
网址 /Web: <http://www.aispeech.com>

思必驰通过自主研发全链路智能对话系统定制开发平台（DUI平台）和人工智能语音芯片, 在智能家电、智能汽车、消费电子等物联网领域, 以及以数字政企类客户为主的生产、生活和社会治理领域（涵盖金融服务、交通物流、地产酒店、政务民生、医疗健康等行业场景）, 提供智能人机交互软件产品、软硬一体化人工智能产品以及对对话式人工智能技术服务。

AI Speech is a professional speech technology and dialogue system technology provider in China. The company is committed to the mission that "communicate everything and manage everything". Based on the company's individually developed DUI and AI voice chip, the company lays out around the "cloud + chip", and provides services of AI technology and products combined by hardware and software. Moreover, it provides intelligent human-machine interaction software products, Software-hardware integrated product and dialogue system technology services to IoT such as intelligent home appliances, smart cars and consumer electronic devices, as well as to digital government and enterprise customers, including finance, transportation, property,

government affairs and healthcare.

#### 主要展品 /Products

思必驰智能家电解决方案, 打通80余家智能家居平台, 为黑电、白电、厨电及小家电等设备厂家提供全链路语音交互技术、语音交互模组、AI芯片等软硬一体化解决方案, 同时为家电厂家提供专业的声学结构评估及语音实验环境搭建等服务, 推动传统家电实现快速智能化落地, 实现全屋智能、互联互通。

AI Speech household electrical appliances solutions, get through more than 80 smart home platforms, providing full-chain voice interaction technologies, voice interaction modules, AI chips and other software and hardware integration solutions for equipment manufacturers such as brown goods, white goods, kitchen appliances and small appliances. Provide professional acoustic structure evaluation and voice experimental environment construction and other services, helps manufacturers intelligently home appliances quickly, and achieves smart home devices fully-connected.

#### STIEBEL ELTRON

#### 世创电能

#### 斯宝亚创（天津）电器有限公司

N4-4D71

#### STIEBEL ELTRON (Tianjin) Electric Appliance Co., Ltd.

地址：天津市西青经济开发区赛达国际工业城C3（300385）  
Add: C3, XEDA International Industry City, Xiqing District  
电话 /Tel: 83962077  
传真 /Fax: 83962077  
网址 /Web: <http://www.stiebeltron.cn/>

世创电能国际集团由菲尔德斯博士于1924年创办于德国柏林, 目前总部设在德国的霍尔茨明登, 是欧洲知名的舒适家居电器及暖通系统产品制造商。

在全球拥有8大生产基地, 26家销售公司, 并在120个国家和地区拥有合作伙伴和经销商, 2004年, 世创电能进入中国, 总部及工厂位于天津, 并在上海和广州设立分公司, 更好地服务全国客户。

STIEBEL ELTRON group, established by Dr. Theodor Stiebel in Berlin, Germany in 1924 is a renowned manufacturer of home electric appliance and HVAC system in Europe. Today with headquarter located in Holzminden, Germany, STIEBEL ELTRON has 8 production bases, 26 sales organizations around the world, plus partners and agencies in 120 countries, endeavoring to deliver electricity-based heating, cooling, ventilation and hot water solutions. In 2004, STIEBEL ELTRON started business in China. The headquarter is located in Tianjin and set up subsidiaries in Shanghai and Guangzhou to better serve the customers all around China.

#### 主要展品 /Products

世创电能致力于向全球客户提供基于电能的采暖、制冷、新风和热水产品及解决方案。凭借舒适、高效、节能等优势, 如今每15秒就增加一位世创电能新用户, 每年超过200多万台产品销往全球, 已成为德国乃至欧洲知名品牌。

STIEBEL ELTRON endeavors to deliver electricity-based heating, cooling, ventilation and hot water solutions. With advantages on comfort level, high efficiency and energy saving, every 15 seconds somewhere in the world, a device made by STIEBEL ELTRON is put into operation. More than 2 million products sold worldwide every year which makes STIEBEL ELTRON a renowned brand in Germany and Europe.

**四川丹甫环境科技有限公司**  
**Sichuan Danfu Environment Technology Co., Ltd**地址: 四川省眉山市青神县丹甫工业园  
电话 /Tel: 02838926386

W5-5E86

公司专业从事小型全封闭制冷压缩机设计、研发及生产制造,拥有近40年的制冷历史,引进具有世界先进水平的高精智能生产设备和软件,年生产能力1500万台。丹甫压缩机具有低电压启动、高效节能、可靠性高、噪声低、体积小等特点,广泛应用于冰箱、饮水机、除湿机、制冰机等制冷产品。

公司秉承“务实创新、追求卓越、诚信回报、永续经营”的经营理念,以互惠互利为宗旨,以诚实守信为根本,热忱地和中外客户共谋发展。

As the main domestic producer of the refrigerating compressor in China, Sichuan Danfu Environment Technology Co., Ltd specializes in the design, research and manufacturing of small hermetic refrigerating compressors and environment test equipment. Danfu introduced advanced high precision and high intelligence production and testing equipment from Italy, Germany, Japan and USA, the annual production capability is up to 15 million units. Danfu Compressor has the advantages of high efficiency, reliable performance, high stability, cost effectiveness, low noise, low volume, light-weight and so on, which can be widely used in refrigerator, freezer, water dispenser, dehumidifiers, ice machine and other refrigerating appliances. Our company adheres to such Business philosophy as “Practical Innovation, Pursuit of Excellence, Good Faith and Business Continuity”. We would like to pursue mutual development via actively cooperating with clients from home and abroad

**主要展品 /Products**

DFB系列高效环保R600a压缩机的研制吸收借鉴了国内外先进的高效压缩机技术,针对R600a制冷剂的特点,对壳体、电机、机体、气阀等关键零部件进行了优化设计,并通过了大量的严格测试和可靠性试验。公司首创的压缩机高工况启动技术、两步干燥法生产工艺技术,大幅提高了压缩机的稳定性。该系列汇集了丹甫自主创新研究和开发的12项国家专利,拥有自主知识产权和关键核心技术。

The research of the high efficiency compressor of DFB series R600a has adopted the advanced high efficiency compressor technology abroad and we have optimized the design on such key parts as shell, motor, engine body, gas valve etc. according to the R600a refrigerant's characteristics, and have passed a great number of strict test and reliability experiment. We greatly improved the stability of the compressor through the advanced start performance and two step desiccation of production technology invented by our company. This series is a collection of the twelve national patents, with core technologies and proprietary intellectual property rights.

**四川迈科隆真空新材料有限公司**  
**Sichuan Micolon Vacuum New Material Co., Ltd.**地址: 四川省达州市宣汉县普光微玻纤产业园 (636156)  
Add: Puguang Micro-fiberglass Industrial Zone, Xuanhan County, Dazhou City, Sichuan Prov., 636150, China  
电话 /Tel: 13983747559  
传真 /Fax: 0818-5619301

W2-2B06 2B05

网址 /Web: <http://www.micron-vip.com>

四川迈科隆真空新材料有限公司,是“四川省高新技术企业”、工业和信息化部“专精特新”企业;公司在保温绝热性能更高的新材料研发和新工艺的研制方面,取得了优异的成绩,以保温绝热性能最优的产品促进行业变革和低碳节能的实现。

公司开发生产的真空绝热板(VIP),以环保材料,超细纤维玻璃棉或气相二氧化硅为原料,具有重量轻、绝热性能高、无毒、无污染、不燃等优点,是目前全球性能最优的保温绝热材料。

Sichuan Micolon Vacuum New Material Co., Ltd is “High-Tech Enterprise of Sichuan Province” “Specialized and Sophisticated Enterprises” of MIIT; Micolon has made excellent achievements in the R&D of new materials and new processes with higher insulation performance. Micolon has promoted industrial reform and the realization of low-carbon&energy with products of best insulation performance.

The Vacuum Insulation Panel(VIP), developed and produced by our company, utilizes environment-protected material-micro glass fiber or fumed silica as raw material and has multi-advantages like light weight, low thermal conductivity, good elasticity, non-toxic, non-pollution, non-combustible and etc. All these advantages make it an ideal choice for thermal insulation and sound-absorbing material.

**主要展品 /Products**

真空绝热板(VIP),以环保材料,超细纤维玻璃棉或气相二氧化硅为原料,具有重量轻、绝热性能高、无毒、无污染、不燃等优点,是目前全球性能最优的保温绝热材料。

与传统保温材料比较, VIP 的主要优势为:

导热系数可低至 1.5mW/mK, 与传统绝热材料(如聚氨酯)相比,隔热性能提升 10 倍以上。厚度仅为传统保温材料的 1/5 ~ 1/10, 产品薄且轻量化,赋予了保温腔更薄的保温层、更大的空间及更轻的重量。

The Vacuum Insulation Panel(VIP), utilizes environment-protected material-micro glass fiber or fumed silica as raw material and has multi-advantages like light weight, low thermal conductivity, good elasticity, non-toxic, non-pollution, non-combustible and etc. All these advantages make it an ideal choice for thermal insulation and sound-absorbing material. VIP is superior to the traditional insulation materials:

1. Thermal conductivity can be as low as 1.5mw/mk which is improved by more than 10 times than traditional insulation materials (PU foam).
2. The thickness is only 1/5 ~ 1/10 of the traditional insulation material, the thin and lightweight of VIP make the insulation chamber lighter, insulation layer thinner to enlarge the use space.

**beoka 倍益康****四川千里倍益康医疗科技股份有限公司**

W3-3B41 3B42

地址: 成都市成华区东三环二段龙潭工业园  
电话 /Tel: 028-84215340

倍益康是一家以“康复科技·关爱生命”为使命,专注于健康产品创新研发的高新技术企业。公司拥有国内外专利 500 余项,产品覆盖电疗、力疗、热疗、氧疗、水疗等领域。凭借二十多年在康复医疗领域的研发、生产及营销经验,倍益康正着力打造国际领先的覆盖个人、家庭及医院的专业化、智能化的理疗康复、运动康复专业品牌。

**主要展品 /Products**

中频电疗仪、便携式深层肌肉按摩仪(筋膜枪)、空气波压力治疗仪、全自动恒温蜡疗机、随身式 MINI 制氧机、便携式气压按摩系统、熏蒸治疗仪、经皮神经电刺激仪、神经肌肉电刺激仪、关节按摩仪、颈部按摩仪、干式水疗床

**CHANGHONG 长虹****四川长虹电器股份有限公司**  
**Sichuan Changhong Electric Co., Ltd****W5-5C11 5B02**

地址: 四川省绵阳市高新区绵兴东路 35 号 (621000)

Add: 35, East Mianxing Road, High-Tech Park, Mianyang, Sichuan, China

电话 /Tel: 0816-2418378

传真 /Fax: 0816-2417371

网址 /Web: www.changhong.com.cn

长虹, 创建于 1958 年, 历经数十年的发展, 如今已发展成为集消费电子、核心器件研发与制造为一体的综合型跨国企业集团。

2022 年长虹品牌价值达 1876.85 亿元人民币, 居中国电子百强第 11 位, 居中国制造业 500 强第 78 位。

多年来, 公司坚持以用户为中心、以市场为导向, 持续为消费者与企业级用户提供卓越的产品与服务。未来, 公司将继续积极布局物联网, 逐步建设成为全球值得尊重的企业。

Changhong, founded in 1958, has developed into a comprehensive multinational enterprise group integrating consumer electronics, core device R&D and manufacturing after decades of development.

In 2022, the brand value of ChangHong has reached 187.685 billion yuan (RMB), ranking 11th among China's top 100 electronics industries and 78rd among China's top 500 manufacturing industries.

Changhong has established subsidiaries in Europe, Australia, Pakistan, Southeast Asia, Russia and Latin, liaison offices in more than 10 countries and regions such as the USA and India, provide products and services in more than 100 countries and regions in the world.

Over the years, the company has adhered to user-centered and market-oriented, and continued to provide consumers and enterprise-level users with excellent products and services. In the future, the company will continue to actively layout the Internet of Things and gradually build itself into a respected enterprise in the world.

**主要展品 /Products**

- 1、Q8K 系列电视拥有 8K 高亮屏幕、真核 8K 芯片、BEF+DBEF 双膜结合增亮技术、8K 影视生态专区、AI 社交娱乐、AI 智慧交互
  - 2、Q6G 系列富氧新风空调: 创新恒温新风系统、95m³/h 超大新风、24-33 分贝超低静音、二氧化碳浓度检测、HEPA 净化模块
  - 3、M 鲜生二代冰箱: 水分子激活保鲜技术、零冲击微微冻技术、F+ 环境新鲜度监测、MNC+ 长效净味杀菌技术、全面薄 GLS 集成技术
- 1、Q8K series TV has 8K highlight screen, eucore 8K chip, BEF+DBEF double film combination bright-up technology, 8K film ecological zone, AI intelligent interaction
- 2、Q6G Enriched Oxygen fresh air conditioner system: New constant tem

**四方光电****四方光电股份有限公司**  
**Cubic Sensor and Instrument Co., Ltd.****W2-2B33 2B34 2B35 2B36**

地址: 武汉市东湖新技术开发区凤凰产业园凤凰园三路 3 号 (430205)

Add: No. 3, Fenghuang Park Third Road, Fenghuang Industrial Park, East Lake New Technology Development Zone, Wuhan

电话 /Tel: 027-87405251

传真 /Fax: 027-87401159

网址 /Web: http://www.gassensor.com.cn/

四方光电股份有限公司是一家从事智能气体传感器和高端气体分析仪器的科创板上市企业 (股票代码 688665)。公司 2003 年成立于武汉“光谷”, 形成了包括光学 (红外、紫外、光散射、激光拉曼)、超声波、MEMS 金属氧化物半导体 (MOX)、电化学、陶瓷厚膜工艺高温固体电解质等原理的气体传感技术平台, 拥有 100 余项国内外专利, 产品广泛应用于空气质量、环境监测、工业过程、安全监测、健康医疗、智慧计量等领域。

Cubic Sensor and Instrument Co., Ltd. is a science and Innovation Board Listed enterprise engaged in intelligent gas sensors and high-end gas analysis instruments (stock code 688665). Founded in Wuhan "Optics Valley" in 2003, the company has formed a gas sensing technology platform based on the principles of Optics (infrared, ultraviolet, light scattering, laser Raman), ultrasound, MEMS metal oxide semiconductor (MOX), electrochemistry, ceramic thick film process, high temperature solid electrolyte, etc., with more than 100 domestic and foreign patents. Its products are widely used in air quality, environmental monitoring, industrial processes Safety monitoring, health care, intelligent measurement and other fields.

**主要展品 /Products**

二氧化碳传感器、室内粉尘传感器、甲醛 & VOC 传感器、集成空品传感器模组、粒子计数器、室外粉尘传感器 & 测试仪、油烟传感器、呼末二氧化碳模块、超声波氧气浓度传感器、超声波氧气流量计、激光氧气传感器、氧化锆氧气传感器、微型红外二氧化碳传感器、DLCO 气体传感器、可燃气体安全监测传感器、电化学 CO 传感器、制冷剂泄漏监测传感器、车用空气质量传感器、热失控监测气体传感器、高温传感器、超声波燃气表 & 模块。

Carbon dioxide sensor, Indoor dust sensor, Formaldehyde & VOC sensor, Integrated empty product sensor module, Particle counter, Outdoor dust sensor & tester, Oil fume sensor, End of call carbon dioxide module, Ultrasonic oxygen concentration sensor, Ultrasonic oxygen flowmeter, Laser oxygen sensor, Zirconia oxygen sensor, Micro infrared carbon dioxide sensor, DLCO gas sensor, Combustible gas safety monitoring sensor, Electrochemical CO sensor, Refrigerant leakage monitoring sensor, Vehicle air quality sensor, Thermal runaway monitoring gas sensor, High temperature sensor, Ultrasonic gas meter & module.





## Panasonic

### 松下电器

松下家电(中国)有限公司

**Panasonic Appliances (China) Co., Ltd**

**N4-4F11**

地址: 浙江省杭州市钱塘区松乔街6号(310018)

Add: No.6 Songqiao Road, Qiantang District, Hangzhou, China

电话 /Tel: 0571-81632789

网址 /Web: <https://panasonic.cn/>

松下集团是全球性电子厂商,从事各种电器产品的生产、销售、服务等事业活动。松下创造的是让生活丰富多彩的“创意”,向全世界的人们提供明天的生活方式提案,为地球的未来和社会的发展不断做出贡献。

Panasonic has put forward the brand slogan "A Better Life, A Better World" to embody its founding management philosophy "to contribute to the progress and development of society through its business activities." Guided by this slogan, the Company is endeavoring to offer "A Better Life, A Better World" to each and every customer around the world across its four core business areas: Consumer Electronics, Housing, Automotive, and B2B.

#### 主要展品 /Products

冰箱、洗衣机、空调,美容个护,厨房电器,生活电器,摄影摄像,视听影音等



苏州爱之爱清洁电器科技有限公司

**Suzhou AZA Clean Electric Technology Co., Ltd.**

**E1-1B36 1B37**

地址: 苏州市吴中区胥口镇浦庄大道3999号(215105)

Add: No. 3999, Puzhuang Avenue, Xukou Town, Wuzhou District, Suzhou 215105, China

电话 /Tel: 051266539481

传真 /Fax: 051266539481

网址 /Web: [www.azaclean.com](http://www.azaclean.com)

研发,生产,销售吸尘器及相关清洁类产品

vacuum cleaner

#### 主要展品 /Products

各类吸尘器

vacuum cleaner



苏州八爪鱼机器人有限公司

**W5-5A43**

电话 /Tel: 0512-57476881

网址 /Web: [www.octopus-robot.cn](http://www.octopus-robot.cn)

苏州八爪鱼机器人有限公司总部位于美丽的苏州金鸡湖畔,是一家深耕智能家用清洁领域,集研发、生产、销售于一体的科技公司,旗下品牌“懒猫同学”在国内外各大平台都享有盛名。

#### 主要展品 /Products

家用智能清洁产品

## Dibea

苏州地贝电器科技有限公司

**SUZHOU DIBEA ELECTRICAL TECHNOLOGY CO.,LTD**

**E1-1A01 1A02**

地址: 苏州吴中区光福镇福利路102-6号(215000)

Add: NO.102-6, FULI ROAD, WUZHONG DISTRICT, SUZHOU, CHINA.

电话 /Tel: 400-828-2055

传真 /Fax: 0512-88184080

网址 /Web: <https://www.dibea.com>

苏州地贝电器科技有限公司成立于2007年,是一家集研发、制造、营销为一体的国家高新技术企业,拥有全球注册品牌Dibea。

地贝坚持全球化品牌战略,不断开拓市场,形成了较为完备的国内外市场网络渠道,产品远销欧洲、美洲、亚洲等世界主要国家和地区。地贝不断强化渠道建设的全覆盖,现已成功入驻境内外主流电商平台,并与众多商家达成了战略合作关系。地贝在全球范围内继续拓展多元化服务体系,全面提升品牌价值。

Suzhou Dibea Electrical Technology CO.,LTD., established in 2007, is a national high-tech enterprise integrating R & D, manufacturing and marketing, with a global registered brand of dibea.

Dibea adheres to the global brand strategy and constantly develops the market, forming a relatively complete domestic and international market network channel. Its products are exported to Europe, America, Asia and other major countries and regions in the world. Dibea continues to strengthen the full coverage of channel construction, and has successfully entered into the mainstream e-commerce platforms at home and abroad, and has reached strategic cooperation with many businesses. At the same time, dibea will continue to expand its diversified service system around the world and comprehensively enhance its brand value.

#### 主要展品 /Products

家用吸尘器,扫地机,除螨仪

Wireless handheld vacuum cleaner, Sweeping robot, mite predators

AZURE WIND  
安泽汶环保

### 苏州工业园区安泽汶环保技术有限公司 Azurewind Cleantec (S.I.P.) Co., Ltd.

E2-2B47

地址: 江苏省苏州市工业园区胜浦镇银胜路 136 号 (215126)

Add: No.136 Yinsheng Road, Shengpu Town, Suzhou Industrial Park, Suzhou City,  
Jiangsu Province

电话 /Tel: 0512-62811966

传真 /Fax: 0512-62811900

网址 /Web: <https://www.azurewind.com>

苏州工业园区安泽汶环保技术有限公司是集空气净化材料研发、产品设计、生产、销售为一体的高新技术企业, 依托在环境及化工催化材料领域的前沿技术, 在空气污染物净化材料方面具有领先的技术优势, 已获得多项国家发明专利。

安泽汶环保专注技术创新, 不仅从各大高校引进精英人才, 构建了核心的自主研发团队, 成立了包括材料合成、材料与产品性能测评及产品开发三个实验室, 还与清华大学等众多高校和科研机构有着紧密的合作关系。

Azurewind Cleantec (S.I.P.) Co., Ltd. is a high-tech enterprise integrating research and development, product design, production and marketing of air purification materials. Relying on the cutting-edge technology in the field of environmental and chemical catalytic materials, Azurewind has a leading technical advantage in air pollutant purification materials, and has obtained a number of national invention patents.

Focusing on technological innovation, Azurewind has not only introduced elites from major universities, built a core independent R & D team, and established three laboratories including material synthesis, material and product performance evaluation and product development, but also has close cooperative relations with many universities and scientific research institutions such as Tsinghua University.

#### 主要展品 /Products

滤料、夹炭布滤网、HEPA 滤网、复合滤网、圆筒滤网

Filter Media, Non-woven Filter Filled with Activated Carbon, HEPA Filter, Composite Filter,  
Cylindrical Filter

### 苏州工业园区建维薄膜开关厂 Jianwei Membrane Switch

W2-2B43

地址: 江苏省苏州市工业园区娄葑创投工业坊 22 栋 (215000)

Add: Building 22, chuangtou Industrial Square, Loufeng, Suzhou, City, Jiangsu Province, China

电话 /Tel: 86-0512-67538836-800

传真 /Fax: 86-0512-67538839

网址 /Web: [www.china-membraneswitch.com](http://www.china-membraneswitch.com)

公司创立 20 年。

专业生产薄膜开关、薄膜面板, 柔性电路。

公司通过 ISO9001、ISO14001 国际管理体系认证。

Jianwei has been established for 20 years.

Specializing in the production of membrane switches, membrane panels, flexible circuits. The company has passed ISO9001, ISO14001 certification.

#### 主要展品 /Products

薄膜开关; 薄膜面板; 柔性线路板

Membrane Switch; Membrane Panel; Flexible Printed Circuit



### 苏州慧闻纳米科技有限公司 Suzhou Huiwen Nano S&T CO., Ltd.

W3-3B13

地址: 苏州工业园区金鸡湖大道 99 号纳米城西北区 17 幢 302 室 (215000)

Add: Room 302, Building 17, Nanopolis, 99 Jinji Lake Ave., Suzhou Industrial Park,  
Suzhou, Jiangsu, China.

电话 /Tel: 0512-62749655

网址 /Web: <http://www.idmsensor.com/>

慧闻科技是一家从事智能传感器研发、生产和销售, 同时提供人工嗅觉解决方案的国家级高新技术企业。公司于 2014 年由来自前 NASA 的科学家团队在苏州成立, 目前已研发出针对多种有毒有害气体 (如甲醛、酒精、氨气、一氧化碳、氮氧化物、硫化氢、甲烷、TVOC 等) 的传感器芯片及相应的检测模块, 在昆山建成了 MEMS 气体传感器、热电堆温度传感器、柔性压力传感器、红外 CO2 传感器模组、激光 PM2.5 传感器生产线。

Huiwen Technology Co. Ltd is a high-tech company that focuses on the development and production of advanced MEMS based intelligent gas sensors and provides a comprehensive solution for gas detection. The multi-channel gas sensor array chips and systems developed by the company have many advantages such as low power consumption, small size, high sensitivity, good selectivity, intelligence and easy integration. At present, the company has developed the sensor chips and sensor modules for a variety of toxic or harmful gases (e.g. formaldehyde, alcohol, ammonia, carbon monoxide, nitrogen oxides, hydrogen sulfide, methane, TVOC, etc.), and a MEMS gas sensor mass production line with 10 million sensor chips annually has been constructed.

#### 主要展品 /Products

MEMS 气体传感器、热电堆温度传感器、柔性压力传感器、红外 CO2 传感器模组、激光 PM 2.5 传感器  
MEMS gas sensors、热电堆温度传感器、Flexible pressure sensor、Infrared CO2 sensor module、Laser  
PM2.5 sensor



### 苏州稼祥新材料科技有限公司

N4-4A31 4A32

#### SUZHOU JIAXIANG NEW MATERIALS TECHNOLOGY CO.,LTD

地址：苏州市相城区春兴路 45 号平谦国际二期 J 栋 (215000)

Add: Building J, Pingqian International(Suxiang) Science Industrial park, Suzhou

电话 /Tel: 051283989235

传真 /Fax: 0512-83987098

网址 /Web: www.jiexiangsteel.com

苏州稼祥新材料科技有限公司将全球首创 3D 数码印刷的金属材料 (DPM) 运用于家电及建筑领域,并结合运用工业 4.0 制造技术, 常温加工低碳环保, 材料可循环。针对全球合作伙伴实现设计, 生产, 流通和售后服务为一体的全方位供给。

革命性的 DPM 材料给金属表面带来了生命力, 并且具有防火阻燃, 抗菌防霉, 防水防潮, 高硬抗划痕, 可折弯, 可充压成型等特性。现有家电合作品牌包括松下、能率、惠而浦、澳柯玛等, 并出口日本。

Jiexiang New Material Technology brings world's leading 3D Digital Printing Material(DPM) into the home appliance and construction. Combined with industrial 4.0 manufacturing technology, low-carbon environmental protection and recyclable materials, we provide integrated solution of design, production, logistic and after sales services for our global partners.

The revolutionary DPM material not only brings vitality to the metal surface, but also has the characteristics of fire retardant, antibacterial and mildew resistant, waterproof, high hardness and scratch resistance, bendable and pressure forming. The existing cooperative brands of household appliances include Panasonic, Noritz, Whirlpool, Aucma, etc., and exported to Japan.

#### 主要展品 /Products

产品技术方面, 稼祥科技通过 5 年的自主研发金属材料表面的 3D 数码印刷技术, 不断实现技术突破, 采用环保 UV 涂料和传统聚酯涂料有效结合, 设计具有个性图案的金属材料并实现工业化生产, 既能保持聚酯类金属材料的强柔韧性, 又能突出 UV 类涂料表面硬度高和抗污染性强的特性, 实现阻燃, 抗菌防霉, 防水防潮, 高硬抗划, 可折弯, 可充压成型等特性, 可完全替代现有覆膜、转印和丝网印刷传统材料, 并大大提高生产使用效率, 降低成本。

In terms of product technology, Jiexiang has continuously invest in research and development of 3D digital printing technology on metal materials and achieved constant breakthroughs over 5 years. Adopts a combination of environmental UV and polyester coating to design metal materials with personalized patterns and realize industrial production, which can maintain the strong flexibility of polyester metal materials, and still highlight the characteristics of high surface hardness and strong antifouling UV coatings, realize the characteristics of fire retardant, antibacterial and mildew resistant, waterproof, high hardness and scratch resistance, bendable and pressure forming, completely replace the traditional film covering, transfer printing and screen printing, greatly improve the production, usage efficiency and reduce the cost.

## KENVOR

### 苏州洁易电器有限公司

#### Suzhou Easyclean Electric Appliance Co., Ltd

E1-1B15

地址: 苏州相城区阳澄湖镇岸山工业区西横港街 6 号 (215138)

Add: No.6,Xihenggang RD.,Yangchenghu Town,Xiangcheng District,Suzhou

电话 /Tel: 0512-66185586

传真 /Fax: 0512-66185589

网址 /Web: www.easyclean.com.cn

苏州洁易电器有限公司位于江苏省苏州市, 距上海约 120 公里。

我公司主要生产家庭用吸尘器, 所有产品均符合 3C、GS、CE、PSE、KC、FCC、EMC、RoHS、Reach 标准; 我们承诺给客户id提供高品质的产品, 并致力于和客户保持长久的合作关系。

Suzhou Easyclean Electric Appliance Co.,Ltd. is located in Suzhou City,Jiangsu Province,which is about 120KM to Shanghai.

Our main products are vacuum cleaner,all our products have obtained 3C、GS、CE、PSE、KC、FCC、EMC、RoHS、Reach approval and proved to be high quality and focus on long standing cooperation with our cusotmers.In order to keep product quality,all the parts we used for our products are from the best supplier in this field.

Though we are not very big manufacturer,but we are reliable and awalys provide you with the best service,best products and best price.

Looking forward to establishing long-term relationship with you and benefit mutually.

#### 主要展品 /Products

家用吸尘器和扫地机  
vacuum cleaner

## 精工开物

设计 | 创新 | 科研 | 服务

### 苏州睿梵工业设计有限公司

#### suzhou redefine industrial design Co., Ltd.

E1-1A31

地址: 江苏省苏州市高新区竹园路 209 号苏州创业园 (215000)

Add: Suzhou Entrepreneurship Park, No. 209 Zhuyuan Road, High-tech Zone, Suzhou City, Jiangsu Province

电话 /Tel: 0512-68799367

传真 /Fax: 0512-68799367

网址 /Web: http://www.redefinedesign.cn/

睿梵设计服务集设计研究、产品设计、品牌策略及后端产业化服务于一体, 涉及家电、智能家居、工业设备、医疗器械、智能机器人、UI 设计等领域。涵盖交互设计, 服务设计, 以及从品牌战略、产品战略、产品线规划、产品定义到产品设计的系统服务; 整合行业研究、用户体验、人机交互、品牌规划以及先进技术工艺方面的资源优势, 为企业发展提供产品策略规划和完整的解决方案, 为客户提供以品牌和产品竞争力为核心的综合解决方案。

**GB-Tech****苏州聚邦电器有限公司****Suzhou GB-Tech Cleaning Appliance Co., Ltd.****E1-1H76**

地址: 江苏省苏州市相城区春申湖中路 128 号

Add: 128 Chunshenhu Road, Xiangcheng District, Suzhou City, Jiangsu Province

电话 /Tel: 13814874457

网址 /Web: <http://www.gbcleantech.com/>

苏州聚邦电器有限公司是苏州双荣企业股东于 2019 年投资的清洁电器类产品的研发与生产企业, 公司位于苏州市相城区双荣工业园内, 公司占地 6 万 5 千平方米, 拥有设计、研发、模具、住宿、橡胶 HEPA 过滤器、喷涂印刷、组装等完整的配套产业链, 目前主要清洁电器配套客户有: 飞利浦、牧田、力奇、白得、伊莱克斯、小米生态链产业企业等。

Suzhou Jubang Electric Co., Ltd. is a research and development and production enterprise of cleaning electrical products invested by the shareholders of Suzhou Shuangrong Enterprise in 2019. The company is located in Shuangrong Industrial Park, Xiangcheng District, Suzhou City. The company covers an area of 65,000 square meters and has design, R&D, mold, accommodation, rubber HEPA filter, spray printing, assembly and other complete supporting industrial chain. At present, the main supporting customers of clean electrical appliances are: Philips, Makita, Nixi, Baide, Electrolux, Xiaomi ecological chain industrial enterprises Wait.

**主要展品 /Products**

GB-P40, GB-P30, GB-P10

**苏州朗高智能科技有限公司****N1-1B30**

地址: 江苏省张家港市经开区振兴路 18 号 (215600)

电话 /Tel: 0512-58983880

传真 /Fax: 0512-58983880

网址 /Web: <http://www.lage-tech.com>

苏州朗高智能科技有限公司是一家专业从事智能家居核心零部件研发、生产、销售的高科技企业。

- 朗高在科技人才大量投入, 目前博士硕士以及多年资深经验的高级工程师;
- 朗高产品拥有 100% 的自主知识产权和多项认证;
- 朗高产品取得了安规、EMC、UL 多项证书。公司是《智能坐便器加热器》和《电坐便器用喷淋加热组件》的起草单位;
- 朗高科技的产品不断完善, 第五代 5.0 加热器已成为翘楚, 倍深受客户青睐。

**主要展品 /Products**

加热器:

多重保护, 防干烧、过温、漏电; 抗冷冻结构

品牌元器件保障能力好; 一致性强

流量温升电压变化, 温控稳定性强

满足 90% 以上客户

电解水

采用独特的电路控制, 不形成水垢

双面电极, 效果增加一倍; 效率 ≥99.9%

结构紧凑, 有固定支架

UVC 杀菌

抗 UV 材料, 防老化; 无需药剂, 无副作用; 抗冷冻结构

光源为 LED 灯珠, 符合《水俣公约》

单灯珠 20mW, 光色纯; 效率 ≥99.99%

**LINKSENSE****苏州灵思实业有限公司****Suzhou Link Sense Industry Co., Ltd****E3-3A47**

地址: 江苏省苏州市吴中区临湖镇和安路 339 号 (215100)

Add: No.339 he'an Road Wuzhong District Suzhou City Jiangsu Province

电话 /Tel: 86-18860925515

传真 /Fax: 86-18860925515

网址 /Web: <https://link-sense.en.alibaba.com/>

苏州灵思实业有限公司, 从 2015 年创立以来, 主要经营家用电器的研发与生产制造, 我们拥有先进的机械设备, 雄厚的技术力量, 经验丰富的员工和完善的质量控制系统, 产品质量是我们重要的经营标准, 设计、研发、营销、质量保证和售后服务于一体。我们专注于创新设计, 秉承创新的理念, 专业的销售团队, 优质的产品和良好服务的理念, 为我们的客户服务, 现有客户已覆盖欧美、日韩等国家。

Suzhou Lingsi Industrial Co., Ltd., since its establishment in 2015, is mainly engaged in the R&D and production of household appliances. We have advanced machinery and equipment, strong technical force, experienced staff and a perfect quality control system. Product quality is our important business standards, design, research and development, marketing, quality assurance and after-sales service in one. We focus on innovative design, adhering to the concept of innovation, professional sales team, high-quality products and good service concept, to serve our customers, the existing customers have covered Europe, America, Japan and South Korea and other countries.

**主要展品 /Products**

手持推杆吸尘器, 手持吸尘器, 车载吸尘器, 干湿两用吸尘器 (洗地机), 桌面吸尘器, 布艺清洗机, 带尘袋的吸尘器, 宠物吸尘器。

Hand stick vacuum cleaner, handheld vacuum cleaner, car vacuum cleaner, wet and dry vacuum cleaner (floor washer vacuum cleaner), desk top vacuum cleaner, spot vacuum cleaner, bagged vacuum cleaner, pet vacuum cleaner.



**苏州迈皓电器有限公司**  
**Suzhou Maihao Electric Co., Ltd****E2-2A31**

地址: 苏州市吴中经济开发区天鹤荡路 2588 号 2 幢 2 层 (215103)  
Add: Floor 2, building 2, No. 2588, tianedang Road, Wuzhong Economic  
Development Zone, Suzhou  
电话 /Tel: 18550841996  
传真 /Fax: 0512-66173540

本公司成立于 2015 年, 生产吸尘器、电动拖把、电动擦窗器、生活日用小家电产品系列的研究、设计、生产与销售的专业制造企业。现有研发与管理人员约 20 人, 生产员工约 70 人, 目前有 5 条生产线。我厂覆盖了自动化流水线的管理, 进一步提高了产值的效率, 更大程度上节约了人工成本。可提供外观与结构设计及 OEM/ODM 服务。公司已通过 ISO9001、BSCI 验厂认证和欧盟环保等权威认证。目前, 已经申请了 20 多项专利。

Suzhou Maihao Electric Co., Ltd. was founded in 2015, located in the young and dynamic coastal city of Suzhou. It is a professional enterprise engaged in the research, development, production and sales of vacuum cleaners, electric mops, electric window cleaners and household appliances. The company has about 20 R & D management personnel and 70 production staff. The company currently has 5 production lines. Our factory covers the management of automated assembly lines, which has further improved the efficiency of output value and saved labor costs to a greater extent. Can provide appearance, structure of design and OEM / ODM services to meet the different needs of customers. The company has passed ISO9001, BSCI and EU environmental protection and other authoritative certifications. At present, we have applied for more than 20 patents.

**主要展品 /Products**

吸尘器、电动拖把、电动擦窗器、生活日用小家电  
Vacuum cleaner, electric mop, electric window cleaner and household appliances

**苏州平云机电科技有限公司**  
**PBM Motor and Fan (Suzhou) Co., Ltd****W1-1C66**

地址: 苏州市苏州工业园唯亭镇朱街 8 号 (215121)  
Add: No.8 Zhuji, Weiting Town, Suzhou Industrial Park, China.215121  
电话 /Tel: 18351639633  
传真 /Fax: 0512-68581674  
网址 /Web: www.pbmmf.com

PBM 主要生产和销售 DC、EC、AC 风扇, 广泛应用于通风、电子制冷、空调等领域, PBM 的产品范围包括轴流风机、离心风机、鼓风机和贯流风机等。

PBM are mainly product and sell DC, EC, AC fans to many countries in the world, which are widely used in ventilation, electronic refrigeration, air conditioning and other fields. PBM product range includes axial fans, centrifugal fans, blowers and cross-flow fan, etc.

**主要展品 /Products**

DC、EC、AC 轴流风机、后向离心风机、前向离心风机、单进风鼓风机, 双进风鼓风机和贯流风机。  
Axial fans, Backward curved centrifugal fans, Forward curved centrifugal fans, Single inlet  
blowers, Double inlet blowers, Cross-flow fans

**苏州荣采创新科技有限公司**  
**Suzhou Glorion Innovation Co., Ltd.****E1-1A03 1A04**

地址: 江苏省苏州市虎丘区玉山路 65 号信达产业园 E 栋 - 荣采创新  
电话 /Tel: 18118106030  
网址 /Web: www.groupgli.com

苏州荣采创新有限公司成立于 2019 年, 是全球重要的家电生产商。荣采创新是一家以人为本的企业。人才是公司最好的资产, 对人才的投资是最有价值的投资。我们拥有完善的培训和发展体系。目前, 我们的员工都是行业的精英, 拥有 10 年以上行业经验。员工股权激励计划正在进行中。我们共同努力, 共同发展。

**主要展品 /Products**

洗地机、吸尘器、宠物护理机等家用清洁电器

**RongXuan****苏州荣炫电器有限公司**  
**Suzhou Rongxuan Electric Co., Ltd.****E1-1B25**

地址: 江苏省苏州市高新区泰山路 288 号 7 栋 (215126)  
Add: No.288, Taishan Road, Suzhou New District, China  
电话 /Tel: 0512-68788318  
传真 /Fax: 0512-68788328

苏州荣炫电器有限公司成立于 2007 年 5 月, 高新技术企业, 科技型企业。致力成为国内一流的吸尘器电动地刷及附件的制造供应商。

公司现有专利 30 余项, 坚持以创新为发展动力, 解决市场痛点为目的。具有研发设计、模具制造、零件生产和装配为一体的整体化能力。有跟日本多家企业合作十多年的研发能力和管理理念, 增强了产品质保能力。

Suzhou Rongxuan Electric Appliance Co., Ltd. was established in May 2007, high-tech enterprises, science and technology enterprises. Is committed to becoming the domestic first-class vacuum cleaner electric floor brush and accessories manufacturing supplier. The company has more than 30 patents, adhere to innovation as the driving force for development, to solve the market pain points for the purpose. With R & D design, mold manufacturing, parts production and assembly as one of the integrated capabilities. With more than 10 years of cooperation with a number of Japanese enterprises research and development capabilities and management concepts, enhanced product quality assurance ability.

**主要展品 /Products**

吸尘器电动地刷, 导电管, 干湿分离器, 吸尘器附件  
Vacuum cleaner electric floor brush, conductive tube, wet and dry separator, vacuum cleaner accessories

## meedo 米多

「我来」

### 苏州瑞久智能科技有限公司

E2-2C81

地址: 苏州虎丘区邓尉路9号润捷广场北楼501室

电话 /Tel: 0512-62817900

网址 /Web: www.meedo.com

瑞久智能科技有限公司为苏州市工业园区高新技术企业, 拥有多项发明专利, 注册资本5000万元, 企业资质良好, 现金流量充足。米多品牌为瑞久公司在家居清洁类电器打造的新品牌, 瑞久米多依靠自身对洗地机及吸尘器产品的研发制造检测多年经营经验, 规划在家居清洁类目打造一个全新品牌。

#### 主要展品 /Products

家用洗地机、扫地机、蒸汽拖把、智能除螨仪

## RETEK 瑞泰克

### 苏州瑞泰克散热科技有限公司

W2-2A11

JINAN RETEK INDUSTRIES INC

地址: 苏州市相城区黄埭镇康阳路368号(215143)

电话 /Tel: 0512-65716583

传真 /Fax: 0512-65715583

公司主要致力于研发和生产冰箱, 冷柜, 饮水机, 展示柜用丝管式冷藏器, 百叶窗式冷凝器, 丝管蒸发器, 吹胀蒸发器和干燥过滤器产品。5G基站散热模具的高效散热板, 电动汽车的液冷板。

公司一直致力于制冷业新技术的创新与发展, 坚持走科技创新之路, 率先使用丝管冷凝器新设计, 来代替高成本的铜管冷凝器, 在低碳环保新形式下, 公司又研发了最紧凑型, 最高效, 产品耐盐雾性能最高的, 二氧化碳介质用丝管冷凝器, 引领行业发展趋势。

#### 主要展品 /Products

冷凝器, 吹胀蒸发器, 干燥过滤器, 太阳能蒸发器, 5G基站散热板, 电动汽车冷板。

## Vacs

### 苏州市伟克斯电器有限公司

N4-4A43

Suzhou Vacs Electrical Co., Ltd.

地址: 苏州市相城区太平工业园顺乐路18号(215137)

Add: No.18 Shunle Road, Taiping Industrial Park, Xiangcheng District, Suzhou, China

电话 /Tel: 0512-65992561

传真 /Fax: 0512-65992562

网址 /Web: www.vacs.cn.com

苏州市伟克斯电器有限公司专业设计制造超静音充电式吸尘器以及配件, 包括宠物梳、除螨刷、电动地刷, 风动地刷等等。同时还拥有丰富的注塑, 模具, 整机组装等研发和生产经验。

除了清洁地板和床上的宠物毛发, 我们的吸尘器还是一个优秀的宠物梳理工具, 梳理宠物身上松散的浮毛, 然后自动吸进吸尘器。对于常见的家庭灰尘, 无论是在低处还是高处, 我们的吸尘器清洁得非常彻底。

Suzhou VACS Electrical Co.Ltd.is specialized and has strong capabilities in the research, design, mould, injection,and assembly of super-silent rechargeable vacuum cleaners, pet grooming combs,mite-removing brushheads,electric and non-electric floor nozzles,storage racks for vacuum cleaner, etc .

Apart from cleaning pet hair from floors and beds,our vacuum cleaner is a great tool for pet grooming by combing down the loose hair from pet body then be sucked into the vacuum cleaner automatically. Not to mention the common dust,whether on the low or high places, our vacuum cleaner can easily get rid of them.

We will continue to launch new products in the near future to do better in the pet grooming market. We sincerely hope to cooperate extensively with domestic and foreign merchants and users.

Looking forwarder to your inquiries.

#### 主要展品 /Products

家用吸尘器, 充电式吸尘器, 宠物吸尘器, 除螨刷, 电动地刷, 宠物毛发梳  
household vacuum cleaner, cordless rechargeable vacuum cleaner, pet vacuum cleaner, mattress cleaner, motorised floor brush, pet grooming tool



沃旗电器  
WOQI ELECTRICS

### 苏州市沃旗电器有限公司

W1-1D99

Suzhou Woqi Electric Appliance Co., Ltd

地址: 苏州市吴江区桃源镇桃乌路1888号

Add: No.1888, Taowu Road, Taoyuan Town, Wujiang District, Suzhou City, Jiangsu, China

电话 /Tel: 13706250040

苏州沃旗电器有限公司, 成立于2021年, 总部位于中国苏州吴江区, 毗邻国际化大都市上海, 风景优美, 交通便利。公司专业从事吸尘器及相关智能清洁健康电器的研发、生产和销售服务, 秉承“科技创造灵动生活”的产品理念, 将创新、品质与服务作为产品制造的核心基因, 专注于为用户提供高品质、高标准、高智慧的 OEM 和 ODM 项目服务。

Suzhou Woqi Electric Co., Ltd. established in 2012, is headquartered in Wujiang, Suzhou, China, near by Shanghai, Our company is a high-tech enterprise engaged in the R & D, production and sales of household appliances such as household vacuum cleaners, mite eliminators and 3-in-1 self-cleaning mop wet dry vacuum cleaner . Our aim is to supply high quality OEM&ODM service.

#### 主要展品 /Products

洗地机、吸尘器、随手吸

**苏州苏大维格科技股份有限公司**  
**SVG tech Group**

W5-5B21

地址: 江苏省苏州市工业园区新昌路 68 号

Add: No.68 Xinchang Road, Suzhou IndustrialPark, Jiangsu, China

电话 /Tel: 0512-62868882

网址 /Web: www.svgoptronics.com

苏州苏大维格科技股份有限公司 2001 年 10 月注册, 2012 年在深交所上市, 是一家以自主研发的三维光刻设备为核心驱动力, 面向信息光子和新型显示领域, 进行光电子材料器件研究和产业化的股份制民营企业。目前公司已发展成为 1 总部 +1 创新中心 +12 个控股子公司, 拥有近 20 万平米厂房, 占地 600 余亩的集团企业。

Registered in October 2001 and listed on the Shenzhen Stock Exchange in 2012, SVG Tech Group is a joint-stock private company that engages in research and industrial operations of optoelectronic materials and devices in the fields of information photonics and advanced display, with self-developed 3D lithography equipment as the core driving force. So far, we have developed into a corporate group consisting of 1 headquarters, 1 innovation center, and 12 subsidiaries, covering an area of more than 600 mu with nearly 200,000 square meters of plants.

**主要展品 /Products**

纳米 3D 印刷材料

交通反光材料

光刻直写装备、智能装备

超薄导光器件

柔性触控模组

Nano 3D printing materials

Traffic reflective materials

Optical direct writing equipment, smart equipment

Ultra-thin light guide devices

Flexible touch module

**苏州索图智能物流设备有限公司**

W3-3D61

地址: 江苏省太仓市城区工业园鞍山西路 129 号 (215400)

电话 /Tel: 0512-53103161

传真 /Fax: 0512-53103161

网址 /Web: www.soto-cn.com

苏州索图智能物流设备有限公司是一家核心设备自主研发和生产的高新技术企业: 创始人周丽女士带领的创业团队, 有 22 年制造业运营管理经验的高管人员、有精益生产管理、智能物流行业人员、有软件开发、电气自动化非标行业、货架技术行业资深人员、更有 20 年管理经验的项目人员。

**主要展品 /Products**

智能物流设备

**苏州威摩尔智能科技有限公司**  
**Suzhou Womow Intelligent Technology Co., Ltd.**

E2-2B10 2B11

地址: 江苏省苏州市相城区高铁新城南天成路 28 号 高清传媒大厦 4 层 (215000)

Add: 4 / F, HD media building, No. 28, nantiancheng Road, high speed rail new town,  
Xiangcheng District, Suzhou City, Jiangsu Province

电话 /Tel: 18914045186

传真 /Fax: 051265907055

网址 /Web: www.womow.net

苏州威摩尔智能科技有限公司, 依托于工厂 10 多年专业外贸设计研发经验, 致力于打造高品质智能化的清洁小家电。工厂拥有高水品的研发设计队伍, 多年来获得国内外专利 200 多项和专业化的实验室, 可完成测试项目 180 多项。Womow/ 万摩尔品牌目前主要在国内外电商平台销售, 并获得客户的高度认可。秉持更好的产品才能使生活更轻松, 我们不断推动产品优化设计, 变得更聪明、更灵敏、更快乐。

Relying on the factory's more than 10 years of professional foreign trade design and R & D experience, Suzhou Weimo Intelligent Technology Co., Ltd. is committed to building high-quality intelligent clean small household appliances. The factory has a R & D and design team of high water products. Over the years, it has obtained more than 200 domestic and foreign patents and specialized laboratories, and can complete more than 180 test projects. Womow / Wanmo brand is mainly sold on e-commerce platforms at home and abroad, and has been highly recognized by customers. Adhering to better products can make life easier. We continue to promote product optimization design to become smarter, more sensitive and happier.

**主要展品 /Products**

万摩尔智能洗地机, 告别传统繁琐的扫、拖、洗, 居家清洁一步到位, 智能变频清洁, 面对不同情况智能调节, 低噪音黑科技, 让生活回归平静, 滚刷脏污及时回收, 净水替换清洁地面, 深度自清洁加强效风干系统, 无盖地刷设计, 全屋清洁无难题, 实时智能语音提示, 告诉你清洁状态, 35 分钟持久续航, 轻松覆盖 200 平大户型。

Wanmo intelligent floor washer bid farewell to the traditional cumbersome sweeping, dragging and washing, home cleaning in one step, intelligent frequency conversion cleaning, intelligent adjustment in the face of different situations, low noise and black technology, so that life can return to calm, roll brush dirt can be recovered in time, clean water can replace the clean ground, deep self-cleaning, enhanced efficiency air drying system, uncovered floor brush design, and the whole house can be cleaned without problems, Real time intelligent voice prompt, tell you the cleaning status, 35 minutes of long-lasting endurance, and easily cover 200 square meters of large houses.



## 苏州雪雁科技有限公司

W3-3H95 3H96

### Suzhou SnomGoose Technology Co., Ltd

地址: 苏州市相城区聚金路 98 号阳澄湖节能环保产业园一幢 403 室 (215100)

电话 /Tel: 18862233997

传真 /Fax: 0512-67593331

苏州雪雁科技有限公司位于中国江苏省苏州市相城区美丽的阳澄湖边上。

公司成立于 2020 年 5 月, 紧跟智能高科技化, 清洁产业链飞速发展的脉搏, 雪雁也萌芽而生, 期待展示更多创新产品。把“持续不断的改善, 追求完美的品质, 完全满足客户需求”作为品质理念, 希望在清洁领域得到广泛的客户群及良好的口碑。

目前主要销售市场有国内、东南亚、台湾、欧洲及北美市场;

#### 主要展品 /Products

主要设计, 研发, 制造洗地机, 吸尘器等业务。



## 苏州伊富斯电器有限公司

N3-3A41

### Suzhou YFS Electrical Appliance Co., Ltd

地址: 江苏省苏州市相城区望亭镇项路村富项路 3-4 号

Add: No.3-4, Fuxiang Road, Xianglu Village, Wangting Town, Xiangcheng District,

Suzhou City, Jiangsu Province

电话 /Tel: 0512-68184013

传真 /Fax: 0512-68184013

苏州伊富斯电器成立于 2014 年, 是一家从事家用吸尘器, 除螨仪等功能性家居清洁产品研发, 生产和销售的高科技企业, 工厂设立于具有“世界吸尘器工厂”美誉的中国江苏省苏州市。

伊富斯以时尚简约的设计著称, 秉承“智享科技, 洁净生活”的品牌理念, 坚持生产完美品质的生活电器, 树立鲜明的品牌风格。并已突破性的技术进行产品革新。采用高品质原材料, 经过多道精细的生产工序和专业品质测试, 不断缔造出高品质的生活电器。

Suzhou YFS electric appliance co., LTD., founded in 2014, is a high-tech enterprise engaged in the research, development, production and sales of functional household cleaning products such as household vacuum cleaner and mite remover.

YFS is famous for its fashionable and simple design, adhering to the brand concept of "enjoy science and technology, clean life", adhering to the production of perfect quality household appliances, and setting up a distinct brand style. And has breakthrough technology for product innovation. Using high quality raw materials, through a number of fine production processes and professional quality testing, continue to create a high quality appliances.

#### 主要展品 /Products

真空吸尘器, 杀菌除螨吸尘器, 洗地机

Vacuum Cleaner, Mite Vacuum Cleaner, Wet and dry vacuum cleaner

## ELEGRP

### 苏州益而益电器制造有限公司 ELEGRP

W5-5D86

地址: 江苏省苏州市工业园区创苑路 158 号

电话 /Tel: 0512-82116666

网址 /Web: <https://www.elegrp.cn/>

益而益集团 (ELEGRP) 创立于 2000 年, 集漏电保护器、接线装置、智能家居、电线电缆与家用水泵为一体的全球领先的智能化电气与机电设备制造商。产品广泛应用于家用电器、个人护理电器、智能卫浴、动力设备及建筑电气。公司业务遍及中国、北美、欧洲等 40 多个国家和地区, 在中国和北美设立仓储配送基地和客户服务中心。与众多全球家电巨头、动力设备领先制造商、智能产品集成商以及国际连锁商超均建立了战略合作伙伴关系。

#### 主要展品 /Products

漏电保护装置 (ALCI、PRCD、LCDI、GFCI 等)

接线装置 (涵盖开关、调光器、感应开关、普通插座、USB 插座、GFCI 插座、直插连接器、自锁连接器、大功率插头等)

智能家居产品 (智能感应开关、智能调光器等)

电线电缆 (电源线插头、线束、线缆等)

家用水泵

## INNOCAC

### 苏州英诺克电器有限公司 Suzhou Innovac Electric Co., Ltd

E2-2B46

地址: 江苏省苏州市相城区阳澄湖镇石田路 7 号

Add: No. 7 Shitian Road, Yangchenghu Town, Xiangcheng District, Suzhou,

Jiangsu Province, China

电话 /Tel: 051285662053

苏州英诺克电器有限公司, 位于江苏省苏州市相城区阳澄湖镇, 是一家专业从事家用清洁产品开发, 制造和销售的公司, 主营产品为吸尘器, 覆盖多个吸尘器产品品类。公司拥有专业的吸尘器测试实验室, 独立的制造车间, 始终为客户提供优质的产品和服务, 产品已远销欧洲, 日韩, 东南亚等几十个国家和地区, 受到客户一致好评。

Suzhou Innovac Electric Co., Ltd which was founded in Nov. 2011, is located in Xiangcheng District, Suzhou of China, which is close to Shanghai. We enjoy convenient transportation on land, water and air. We are a manufacturer for vacuum cleaners, we have ISO9001 and BSCI certificates.

Our factory has 8,000 SQ meters with 5 assembly lines. Annual production capacity can reach 1.5 million pieces of vacuum cleaners.

We have about 130 employees, all our engineers, technicians and QC have been working in vacuum cleaner industry for many years with rich experience.

Our vacuum cleaner covers from canister type to handheld, to stick type and multi cyclone type, all our models obtain certifications including GS, CE, EMC, EMF, ROHS, ERP etc.

Whatever changes, we, Suzhou Innovac Electric Co., Ltd, will always be here to support you. Thank you!

#### 主要展品 /Products

真空吸尘器

vacuum cleaner



**zeka**  
志佳

苏州志佳电子科技有限公司

E2-2A30

SUZHOU ZEKA ELECTRONIC TECHNOLOGY CO.LTD

地址: 江苏省苏州市相城区黄埭镇春申路 995 号 (215000)

Add: 995 Chunshen Road, Huangdai Town, Xiangcheng District, Suzhou City, Jiangsu Province

电话 /Tel: 18013292320

传真 /Fax: 400-8230-830

网址 /Web: www.zekachina.com

为了行业更好发展, 2014 年成立苏州志佳电子科技有限公司, 注册资金 2000 万。ZEKA 如守护者般, 打造森林一般的健康生态环境, 以捍卫家人的健康为使命

Zeka(志佳) 荣获“高新技术企业证书”、“江苏省质量服务诚信AAAAA级单位”、“江苏省优秀民营企业”

Zeka(志佳) 志在创造优质佳品, 志佳的诞生源于一种深刻的体验, 源于一种对家人本能的关爱! 志佳为捍卫孩子的蓝天而生, 以捍卫家人的健康为使命

In order to develop the industry better, Suzhou Zhijia Electronic Technology Co., Ltd. was established in 2014 with a registered capital of 20 million yuan. ZEKA, like a guardian, creates a healthy ecological environment like a forest and takes protecting the health of family members as its mission

Zeka(Zhijia) won the high-tech enterprise certificate, Jiangsu Province Quality service integrity AAAAA level unit, Jiangsu Province excellent Private enterprise

Zeka aims to create high-quality products. The birth of Zeka originates from a profound experience and an instinctive love for family members! Zhijia was born to protect the children's blue sky, to protect the health of the family as a mission

**主要展品 /Products**

本公司专注于空气净化器、空气消毒机的研发设计、生产制造及销售运营, 为家庭、办公、医院等场所提供一流的空气清洁、消毒解决方案, 改善人们因环境因素造成的亚健康生活状态, 以优质的性能和贴心的服务全方位呵护您的健康。

The company focuses on the research and development, design, manufacturing and sales operation of air purifier and air disinfection machine, providing first-class air cleaning and air disinfection solutions for home, office, hospital and other places, to improve people's sub-health living conditions caused by environmental factors, with high quality performance and intimate service to protect your health.

**SONY**

索尼(中国有限公司)

W4-4E31

Sony (China) Ltd

地址: 上海市浦东新区居里路 361 号 (201203)

Add: No.361, Juli Road, Pudong District, Shanghai

电话 /Tel: 61216121

传真 /Fax: 86-21-61216127

网址 /Web: https://www.sony.com.cn

索尼集团公司是世界上民用及专业视听产品、游戏产品、通信产品、核心部件和信息技术等领域的先导之一。它在音乐、影视、互动娱乐以及在线业务方面的成就也使其成为全球领先的创意娱乐公司。

Sony Corporation is responsible for the Electronics Products & Solutions (EP&S) business in the Sony Group. With the vision of "continuing to deliver Kando and Anshin to people and society across the world through the pursuit of technology and new challenges," Sony will create products and services in areas such as home entertainment & sound, imaging, and mobile communications

**主要展品 /Products**

依托深厚的研发实力和先进的影像处理技术, 索尼显示产品与技术的优势覆盖家庭娱乐及商用领域。BRAVIA 全系电视新品, 产品阵容丰富、音画质优异、智能应用便捷, 可满足消费者的多元需求, 提供沉浸式家庭娱乐体验。多款新品搭载新 XR 认知芯片, 充分发挥各类显示技术的潜能, 再度提升音画表现。大型显示产品涵盖黑彩晶、商显和投影机等专业产品解决方案, 具有高画质、出色的系统兼容性、专业的售前到售后服务, 可支持多种场景。

With deep R&D strength and advanced image processing technology, Sony display products and solutions have advantages in the field of home entertainment and also business.

The new TV series of BRAVIA products with a rich product lineup, excellent sound and picture quality, and convenient intelligent application, can meet the diverse needs of consumers and provide an immersive home entertainment experience. Part of new products are equipped with new XR cognitive chips, giving full play to the potential of various display technologies, and improving the performance of sound and picture once again.

Large display products cover Crystal LED, commercial display, projectors and other product solutions, with outstanding picture quality, unified color management, rich products, and professional services to support a variety of application scenarios.

**MAJADE**

台州市铭佳电器有限公司

N1-1B44

Taizhou MAJADE Electric Appliance Co., Ltd.

地址: 浙江省台州市路桥区桐屿街道坝头工业园区

Add: Batou Industrial park, Tongyu subdistrict, Luqiao district, Taizhou City, Zhejiang Province, China.

电话 /Tel: 057682652690

网址 /Web: https://www.cnminjia.com/

公司成立于 2003 年, 专业生产突跳式双金属温控器、热水器温控器、液体膨胀式温控器、旋转开关、万能转换开关和船形开关六大系列产品。产品已通过 CE, TUV, UL, CUL, CQC 等多国安全认证产品, 已销往国外。质量稳定可靠, 已充分得到了客户的认可与信任。本公司目前已拥有自主知识产权的标准厂房, 稳定的管理团队, 培训有素的员工队伍, 完整和先进的生产设备和检测手段。期待与您的合作!

Taizhou MAJADE Electric Appliance Co., Ltd. founded in 2003, specializes in the production of six sets of products, including bimetal thermostats, thermostats for water, liquid expansion thermostats, rotary switches, universal changeover switches and rocker switches. Our company have obtained TUV, CE, UL, CUL and CQC certification, also have been selling our products to many European and American countries, such as the United States, Britain, France, Mexico, Canada, Australia, Italy, South America, etc. Our company now owns standard workshops of

independent property rights, stable management team, well-trained staff, complete and advanced production equipment, and testing means. Look forward to cooperating with you.

#### 主要展品 /Products

突跳式双金属温控器、热水器温控器、液体膨胀式温控器、旋转开关、万能转换开关和船形开关  
Bimetal thermostats, Thermostats for water, Liquid expansion thermostats, Rotary switches, Universal changeover switches and Rocker switches.



#### 台州威锦贸易有限公司 Taizhou Weijin Trade Co.,Ltd

W3-3A24

地址: 浙江省台州市椒江区海龙路 370 号 302 (318000)

Add: 320#370, Hailong Rd. Jiaojiang, Zhejiang, China

电话 /Tel: 0576-88833112

传真 /Fax: 0576-88833112

三森公司自 98 年成立后, 一直致力于各类传感器的研发与销售。所从事的领域非常广泛。

台州威锦作为三森 3 个海外事业部之一, 受三森公司的直接领导。对外负责产品负责三森产品的销售与客户维护, 对内参与报告行业动向和预研项目的立项, 直接对接三森社长。目前在国内外只要向电器类制造商提供各类液位, 着座感应器和微动传感器, 如科勒, AO 斯密斯等。

#### 主要展品 /Products

触控传感器



#### 天长市泽创电子科技有限公司 TIANCHANG TRUMPSXP ELECTRONIC TECHNOLOGY CO LTD

W3-3B12

地址: 天长市经济开发区纬一路南侧经四路西侧

Add: South Weiyi Road and west Jingsi Road, Economic Development Zone,

Tianchang city, Anhui, China (Mainland)

电话 /Tel: 18018654701

网址 /Web: www.trumpsxp.com

泽创(创普)电子科技有限公司利用自身多年产品的技术优势开发研制的空气净化器产品系列, 新颖的功能设计, 国际化的外观风格, 广受客户喜爱和好评, 成为众多客户 OEM、ODM 产品优选方案。在未来, 泽创(创普)电子科技有限公司不断重视新技术新产品的开发和生产自动化水平的提高及检测设备仪器的完善, 并以高品质的管理, 使产品不断推陈出新, 来满足客户的需求。

Trumpsxp uses the technical advantages of its products for many years to develop the air purifier product series, novel functional design, international appearance style, widely loved and praised by customers, become many customers OEM, ODM product preferred solution. In the future, zechang will continue to pay attention to the development of new technology and new products, the improvement of production automation level and the improvement of testing equipment and instruments, and with high-quality management, make products continue to bring forth the new, to meet the needs of different customers.

#### 主要展品 /Products

主要生产负离子发生器, 臭氧发生器等 应用于空气净化及水处理, 如空气净化器、美容美发护理、空调、吸尘器、灯具、冰箱、洗衣机等。创普电子全面采用严格的国际质量管理体系进行生产管理和质量控制并通过了 ISO9001 质量体系认证 ISO14001 环境管理体系认证, 同时也先后获得 CCC、CQC、CE、UL、TUV、SGS、REACH、CB 等国内外认证。积极准备通过 IATF16949 体系。

Products are mainly used in air purification and water treatment, such as air purifier, beauty care, air conditioning, vacuum cleaner, lamps, refrigerators, washing machines, kitchen bathrooms, drinking water equipment, etc. TRUMPSXP fully adopts strict international quality management system for production management and quality control, and has passed ISO9001 quality system certification and ISO14001 environmental management system certification. At the same time, it has also obtained CCC, CQC, CE, UL, TUV, SGS, REACH, CB and other certifications at home and abroad. Actively prepare for the adoption of the IATF16949 system, so that more and more automotive brands use trumpsxp's automotive air purification solutions.



生活白科技 | 居家小确幸

#### 添可电器有限公司 TINECO

N3-3F31

地址: 中国·苏州市吴中区友翔路 18 号 (215104)

电话 /Tel: 13136767933

传真 /Fax: 13136767933

网址 /Web: www.tineco.com

TINECO 添可是一家专注智能科技的创新公司, 倡导“生活白科技, 居家小确幸”, 以智能科技创造梦想生活。

20 多年来, 从发明第一台卧式中心过滤吸尘器, 到发明会思考的智能吸尘器飘万、智能洗地机芙万, 在智能家居清洁生活电器领域不断探索升级, 并延伸至个人护理、烹饪料理和健康生活品类, 发明智能吹风机、智能眼部美容仪、智能美发梳、智能料理机和智能空气净化器, 强势崛起, 打造高端智能产品家族。

Founded in 1998, Tineco is a hi-tech company and a wholly-owned subsidiary of ECOVACS Group (SHA: 603486) dedicated to the R&D of innovative technologies and the engineering of premium smart household electronics.

In 2019, Tineco disrupted the vacuum cleaner industry with the launch of its first smart vacuum cleaner “Pure One”, which redefines home cleaning with intelligent dust sensing technology. Later, Tineco introduced a revolutionary smart wet dry vacuum cleaner “Floor One” which soon harvested worldwide recognition.

Moving forward, Tineco is going to make full of its 20-year heritage, reshape it for a better future, and keep creating exciting products that are helpful, easy to use, and smart.

#### 主要展品 /Products

会思考的智能吸尘器飘万 PURE ONE LIGHT、智能洗地机芙万 FLOOR ONE 2.0 LCD、智能洗地机芙万 FLOOR ONE 2.0slim; 智能吹风机摩万 MODA ONE、智能眼部美容仪娇万、智能美发梳秀万 1.5、智能美发梳秀万 2.0、智能料理机食万 2.0、智能料理机食万 3.0 和智能空气净化器芳万

FLOOR ONE S5 PRO、FLOOR ONE S5 COMBO、FLOOR ONE S3、PURE ONE S12、MODA ONE、ZIVA ONE



专业制造: NTC 温度热敏电阻 NTC 温度传感器

### 通城县大鑫智能传感科技有限公司

W4-4B21

#### Tongcheng Daxin Intelligent Sensor Technology Co., Ltd.

地址: 湖北省通城县经济开发区孵化园 (437499)

Add: Incubation park city county, hubei province economic development zone

电话 /Tel: 0715-4839939

传真 /Fax: 0715-4839939

网址 /Web: www.dgdaxin-sensor.com

通城县大鑫智能传感科技有限公司, 东莞市大鑫传感器科技有限公司专业从事高精度 NTC 热敏电阻, NTC 温度传感器的研发、生产、销售。产品广泛用于家用电器, 办公电器, 移动通讯, 新能源, 医疗, 安防等其它工业控制领域。

Tongcheng Daxin Intelligent Sensor Technology Co., Ltd., dongguan Daxin technology co., LTD. Specializes in high precision NTC thermistor sensor, NTC temperature sensor research, development, production and sales. Products are widely used in household appliances, office appliances, mobile communications, new energy, medical, security and other industrial control field.

#### 主要展品 /Products

高精度 NTC 热敏电阻, NTC 温度传感器

High precision NTC thermistors and NTC temperature sensors



德国威能. 舒适你的世界

### 威能 (中国) 供热制冷环境技术有限公司

N1-1F81

#### Vaillant Group (China) Heating, Cooling and Environmental Technology Co., Ltd.

地址: 上海市黄浦区鲁班路 558 号经纬国际大厦 12-15 层 (200023)

Add: 12-15F Jingwei International Plazat, No.558 Luban Road, Huangpu District, Shanghai

电话 /Tel: 021-60287900

传真 /Fax: 021-60287900

网址 /Web: www.vaillant.cn

Vaillant, 德国威能创立于 1874 年, 拥有 140 多年的发展历史, 是欧洲供热 / 生活热水 / 通风及空调设备制造商, 专注于为舒适家居生活的舒适性提供智能化解决方案。作为供热、生活热水领域的市场先行者, 除了常规能源供热设备, 德国威能还致力于使用可再生能源的系统解决方案。截至 2021 年, 德国威能在中国已销售超过 200 万台壁挂炉, 在全球 60 多个国家拥有 3 千万顾客, 以其品质和优质的服务赢得了全球用户的尊重。

Founded in Remscheid in 1874, the Vaillant Group today supplies innovative hot water, room heating and cooling solutions to countries all over the world. As a global market and technology leader in the fields of heating, ventilation and air-conditioning technology. Vaillant develops high-efficiency products that save energy, conserve resources and enhance people's quality of living. In 1995, Vaillant officially entered the Chinese market. In 2015, Vaillant moved its functional headquarters and core business units in China to Shanghai as regional headquarters. In 2021,

Vaillant has sold more than 2,000,000 wall-hung boilers in China.

China is one of the main sales markets of Vaillant, we provide wall-hung boilers, commercial boilers, water boilers, air conditioners, ventilation system, water treatment series, heat pump and other product renewable energy sources to meet the diverse needs of Chinese consumers for a healthy and comfortable life.

#### 主要展品 /Products

全套采暖及系统解决方案 (燃气壁挂炉、电壁挂炉、地暖或散热片等系统组件), 新风系统, 燃气热水器, 电热水器, 热泵和空调, 水处理系统 (反渗透净水机、中央净水机、软水机、前置过滤器), 商用锅炉

Heating system ( Gas wall-hung boilers, Electric wall-hung boilers, System components ), Ventilation System, Gas water boilers, Electric water boilers, Heat pump and Air conditioners, Water treatment, Commercial boilers



### 伟视得电子贸易 (上海) 有限公司 VESTEL GROUP

N4-4F01

地址: 上海黄浦区淮海中路 93 号大上海时代广场六楼

电话 /Tel: 021-63847922

网址 /Web: www.vestel.com

伟视得 VESTEL 集团是一家以家用电器为主集研发, 设计, 生产为一体的生产企业。伟视得集团拥有强大的生产基地在欧洲土耳其的梅利萨。公司主要产品有: 冰箱, 洗衣机, 彩电, 洗碗机, 烤箱, 电灶等。公司年生产 3500 万件家用电器产品, 出口到全球 155 个国家, 与 1500 多个客户有着良好的业务往来。公司在土耳其梅利萨拥有一百多万平方米的生产, 研发基地, 和 16000 多名制造研发工作人员。

#### 主要展品 /Products

Vestel 每年生产 3500 件家电产品。这次 AWE 展会主要展出了白电产品: 大冰箱, 大容量滚筒洗衣机, 大容量干衣机, 各类洗碗机, 厨房电器, 烤箱, 电灶等。在白电, 厨电方面品类全, 型号多, 功能齐全。



### 温州高巨标牌有限公司 Wenzhou Gaoju Sign Co., Ltd.

W1-1A57

地址: 浙江省温州市苍南县金乡镇上乾头村康发路 188-6 号

电话 /Tel: 0577-68100650

传真 /Fax: 0577-68100650

温州高巨标牌有限公司, 位于浙江省温州市苍南县金乡镇, 现有员工 50 人, 公司拥有行业内完整的产业链。主要产品: 标牌铭牌, 各种材质 LOGO 标志定制、电镀铜镍分体标、等各类标牌铭牌。并且以中国知名品牌企业合作、如安徽美的 广州奥马、欢迎各界朋友莅临参观、指导和业务洽谈。

#### 主要展品 /Products

拥有行业内完整的产业链 ( 模具从自由设计无形到有形、抛光、拉丝、涂布、晒版、曝光、显影、电镀、脱模、上胶、组合、模切、激光上色 UV 印刷、丝印移印, 组装、检查包装)。主要产品: 标牌铭牌, 各种材质 LOGO 标志定制、电镀铜镍分体标、镍片金属 LOGO、PET 电镀金属分体 LOGO、车标车贴、彩色感压水晶分体标 ( 万能贴) 等各类标牌铭牌。

**KEXN® 科信**

健康产品 health product

**温州科信健康产品有限公司****Wenzhou Kexin Health Product Co., Ltd.****E2-2B26**

地址: 浙江省温州市飞云新区孙敖公路 A-888 号

电话 /Tel: 17858390251

网址 /Web: www.kexinchina.com

温州科信健康产品有限公司创办于 2005 年 6 月, 是一家专门从事研发、生产及销售按摩健康用品的企业。公司专业生产和销售各种按摩棒、按摩靠垫、颈肩按摩器、脚底按摩器、迷你按摩器等系列健康产品。产品行销全国各地, 并远销至、东南亚、日本、土耳其、欧盟等地, 深受广大消费者信赖和喜爱。

**主要展品 /Products**

公司专业生产和销售各种按摩棒、按摩靠垫、颈肩按摩器、脚底按摩器、迷你按摩器等系列健康产品。

**AIBATE 艾芭特®****温州美仕贸易有限公司****Wenzhou Meishi Trading Co., Ltd****N1-1B21**

地址: 浙江省温州市永嘉县乌牛街道祥池社区 (乌牛镇白草园培训中心内) (325000)

电话 /Tel: 13706672482

温州美仕贸易有限公司成立于 2014 年 06 月 18 日, 注册地位于浙江省温州市永嘉县乌牛街道祥池社区 (乌牛镇白草园培训中心内), 法定代表人为闫三保。经营范围包括一般项目: 家用电器销售; 日用百货销售; 五金产品批发; 五金产品零售; 日用品销售; 金属工具销售; 日用电器零售; 厨具用具及日用杂品零售; 厨具用具及日用杂品批发; 电气机械设备销售; 家用电器安装服务 (除依法须经批准的项目外, 凭营业执照依法自主开展经营活动)

Wenzhou Meishi Trade Co., Ltd. was founded on June 18, 2014, and its registered office is located in Xiangchi Community, Wuniu Street, Yongjia County, Wenzhou City, Zhejiang Province (in the training center of Baicao Yuan, Wuniu Town). Its legal representative is Yan Sanbao. Business scope includes general items: sales of household appliances; General merchandise sales; Wholesale of hardware products; Retail of hardware products; Commodity sales; Sales of metal tools; Retail of household appliances; Retail of kitchenware, sanitary ware and daily necessities; Wholesale of kitchenware, sanitary ware and daily necessities; Sales of electrical machinery and equipment; Home appliance installation services (in addition to the projects that need to be approved according to law, carry out business activities independently according to law with the business license)

**主要展品 /Products**

水槽 保险柜 移动空调

**PRI  
TECH****温州匹奇电器有限公司****WENZHOU PRITECH ELECTRIC CO., LTD****E3-3B01**

地址: 浙江省温州市龙湾区玉苍西路 29 号 (325000)

Add: No 29 Yucang Road West, Wenzhou, Zhejiang, China

电话 /Tel: 13968858070

传真 /Fax: 0577-88155670

网址 /Web: www.pritech.cn

PRITECH 匹奇, 起源于香港, 创建于 2004 年, 现已发展成为一家专注于个人美容护理领域的技术研发与创新设计企业。公司以经营美容美体类电器和美发剃须类电器等个人护理电器产品为主。企业历经多年发展, 产品远销世界各地, 累计超过 100 多个国家及地区。

**主要展品 /Products**

电动磨脚器、电动洗澡、卷发棒、电推剪、剃须刀等

**爱哈  
标牌****温州市爱哈标牌有限公司****Wenzhou AiHan sign Co., LTD.****W4-4B57**

地址: 浙江省温州市苍南县金乡镇下泽汤路 205 号 (325805)

Add: Wenzhou cangnan county of zhejiang province gold villages and towns under the soup road no. 205

电话 /Tel: 18858791825

传真 /Fax: 18858791825

温州爱哈标牌有限公司成立于 2018 年, 工厂位于标牌之乡浙江省温州市苍南县, 专业制造各种金属标牌。做标牌, 我们是专业的! 欢迎新老客户前来洽谈合作!

Wenzhou AiHan sign co., LTD. Was established in 2018, the factory is located in the sign of the township wenzhou cangnan county, zhejiang province, specialized in manufacturing all kinds of metal signs. Do sign, we are professional! Welcome new and old customers came to discuss cooperation!

**主要展品 /Products**

金属标牌

Metal sign





### 铭源标牌

#### 温州市铭源标牌有限公司

W4-4B23 4B24

#### Wenzhou City Mingyuan Sign Co., Ltd

地址: 浙江省温州市苍南县金乡镇工业一街 238 号 (312805)

Add: 238 First Industrial Street, Jinxiang town, Cangnan County, Wenzhou city

电话 /Tel: 0577-64577660

传真 /Fax: 0577-64577660

温州铭源标牌有限公司一家集开发、设计、制作为一体的现代化企业。

专业为汽车、摩托车、电动车、家用电器、地名标志牌、交通标识牌、车船、路门牌及二维码标识牌等行业的标牌印刷配套。

目前合作客户有: BOSH、中国中车、海信电器、三菱冰箱、TCL 家用电器、创维冰洗家电等。企业配套 各类标牌, 40% 左右的产品出口到欧洲、美洲等国家, 受到各地区客户广泛好评。

Wenzhou Mingyuan Signs Co., Ltd. is a development, design, production as one of the modern enterprise. Professional for cars, motorcycles, electric vehicles, household appliances, place signs, traffic signs, vehicles, road signs and two-dimensional code signs, such as the industry's sign printing supporting. At present, the cooperative customers are: Bosh, China Zhongche, Hisense Electric Appliance, Meiling refrigerator, TCL household appliances, chuang-wei ice-cleaning appliances. Supporting enterprises, all kinds of signs, about 40% of the products exported to Europe, the Americas and other countries, by the region's customers widely praised.

#### 主要展品 /Products

公司拥有全套的表面处理设备, 先进的检测手段和完善的服务, 为汽车、摩托车、电动车、家用电器、地名标志牌、交通标识牌、车船、路门牌及二维码标识牌等行业的标牌印刷配套。

目前合作客户有: BOSH、中国中车、海信电器、三菱冰箱、TCL 家用电器、创维冰洗家电等。企业配套 各类标牌, 40% 左右的产品出口到欧洲、美洲等国家, 受到各地区客户广泛好评。

our company has a full range of surface treatment equipment, advanced detection means and perfect service, and has imported all self screen printing machine, Haitian injection molding machine, CNC engraving machine, hydraulic press and other equipment i



#### 温州太科电子有限公司

N2-2B23

#### Tecoo Electronics Co., Ltd

地址: 浙江省温州市鹿城区仰义街道沿繁路 37 号

Add: No.37, Yanfan Road, Yangyi Town, Lucheng District, Wenzhou, Zhejiang

电话 /Tel: 13738373516

传真 /Fax: +86-577-89776016

网址 /Web: <https://www.elecontro.com/>

Elecontro® 是专业的家用电器控制器公司。我们专注于家用电器控制器的研发和制造, 提供具有极致设计质量和完美用户体验的优质控制器, 在欧洲、美洲、中东和世界各地均有销售。

我们秉承“致力于设计完美产品, 让终端用户享受卓越体验”的愿景, 不断追求完美设计、优质用户体验、一体化供应链体系、精益制造和以客户为中心。我们坚持不懈地打造价格实惠的优质产品, 让世界人民通过创新技术享受快乐美好的生活。

Elecontro® is one of the world's leading household Appliances electronic controllers companies. Elecontro® expertises in R&D and Manufacturing of Household Appliances electronic controllers. We deliver premium controllers with extreme design quality and perfect user experience. Elecontro® products are available in Europe, America, Middle East and all over the world. Embracing our vision of “Committed to design perfect products, let end user enjoy excellent experience”, Elecontro® continuously pursues perfect design, high-quality user experience, integrated supply chain system, lean manufacturing and customer-centric. We relentlessly builds premium products with affordable prices to let people in the world enjoy a joyous and wonderful life through innovative technology.

#### 主要展品 /Products

嵌入式烤箱控制器, 迷你烤箱控制器, 烤箱计时器, 油烟机控制器, 洗衣机控制器

Built-in oven controller, Mini oven controller, Oven timer, Range hood controller, Washing machine controller



#### 温州智荣健康科技有限公司

E1-1D86

#### Wenzhou Zhirong Health&Science Technology Co., Ltd

地址: 浙江省温州市平阳县昆阳镇服饰园区联东北路 129 号 (325400)

Add: No. 129, North Liandong Road, Clothing Garden, Kunyang, Pingyang

电话 /Tel: 0577-63636111

传真 /Fax: 0577-63636111

网址 /Web: [www.cozymate.cn](http://www.cozymate.cn)

温州智荣健康科技有限公司位于浙江省温州市平阳县; 企业建筑面积 18811.86m<sup>2</sup>, 现有职工 230 人, 公司是一家集研发、生产、和销售为一体的专业智能按摩椅、按摩器具制造商。在行业顶尖团队带领下, 公司生产的智能按摩椅、按摩器具远销海内外 39 个国家和地区。得到广泛好评!

Wenzhou Zhirong Health&Science Technology Co., Ltd is located in Pingyang, Wenzhou. Factory building area 18811.86 square meters, total employees 230. Our company is professional massage chair and massager manufacturer focusing in R&D, production and sales. Under senior industry pioneers' leading, our massage chairs and massagers are sold to 39 countries and gain customers' satisfactions.

#### 主要展品 /Products

按摩椅型号: Z100, Z200, Z150, Z160, Z17, Z18, Z19, Z02, Z200G 等

Massage chair model: Z100, Z200, Z150, Z160, Z17, Z18, Z19, Z02, Z200G

## VULKAN LOKING

无锡伏尔康科技有限公司

WUXI VULKAN Technologies Co., Ltd.

W2-2A40

地址: 江苏省无锡新区新洲路科技产业园 93D-3 号 (214028)

Add: Xinzhou Road | Lot 93D-3 in Wuxi Science & Technology Industrial Park Jiangsu Prov

电话 /Tel: 051085342222

传真 /Fax: 051085342345

德国 VULKAN 集团成立于 1889 年, 是联轴器、离合器、管路连接件等产品的国际著名跨国公司, 总部位于德国北威州鲁尔工业区 Herne。集团在全球设有 20 个独资子公司和 30 余家代表处。

无锡伏尔康科技有限公司是德国 VULKAN 集团的在华全资子公司, 亚洲的技术、生产中心和基地, 中国的售后服务中心和基地。

VULKAN group, founded in 1889, is an internationally renowned multinational company with headquarters in Herne, Ruhr, Germany, for coupling, clutch, pipe fittings and other products. The group has 20 wholly-owned subsidiaries and more than 30 representative offices around the world. Wuxi Vulcan Technology Co., Ltd. is a wholly owned subsidiary of VULKAN group in China, a technology and production center and base in Asia, and a service center and base in China.

### 主要展品 /Products

生产弹性联轴器, 传动装置, 减震装置, 管路接头, 弹丸, 过滤器, 橡胶及其他非金属制品模具, 轴承; 并提供上述产品的技术服务和咨询, 上述产品的批发及进出口业务

Production of elastic couplings, transmission, shock absorbers, pipe joints, pellets, filters, rubber and other non-metallic products mold, bearing; and to provide technical services and advice on the above products, the above products wholesale and import and export business



好手HAOLI力

无锡好力泵业有限公司

WUXI HAOLI PUMPS INDUSTRIAL CO., LTD.

N4-4A18

地址: 无锡市惠山区阳山镇人民西路

电话 /Tel: 18861789888

无锡好力泵业有限公司成立于 1998 年, 是一家专业以研发、生产和销售排水泵的高新技术企业, 经过 20 多年的发展, 公司建筑面积近 8 万平方米, 现有员工 380 余人, 其中专业工程师 42 名, 目前年产能达 2500 万台。产品先后通过了 CCC、VDE、UL 等一系列认证。产品广泛应用于洗衣机、干衣机、洗碗机等领域。目前已成为三星、松下、倍科、美的等品牌主力供应商, 2022 年全球市场份额名列前三。

Established in 1998, Wuxi Haoli Pumps Industrial Co., Ltd. is located in Yangshan Town named peach hometown, by developing, producing and selling drain pump series. The factory covers over 80,000 square meters. There are 380 employees, including 44 specialized engineers. The annual capacity are 25,000,000 pieces drain pumps. Our products have been approved with authentication of CCC, VDE, CQC, CE, CB and UL, etc. They are intensively applying to washing machine, dish-washer, dryer machine, ice machine, industrial air conditioning and various kinds of medical machines.

### 主要展品 /Products

洗衣机排水泵, 干衣机排水泵, 洗碗机排水泵

DRAIN PUMP



无锡市万力粘合材料股份有限公司

W3-3A43

地址: 江苏省无锡市新吴区长江南路 17-17 号

电话 /Tel: 0510-85344823

传真 /Fax: 0510-85347822

网址 /Web: wlnh.net

无锡市万力粘合材料股份有限公司成立于 1995 年, 是一家从事胶粘剂, 功能涂料产品研发、生产、销售为一体的多元化企业, 是国内首家汇集 PUR 热熔胶、双组份 PU 胶、EVA 热熔胶、热熔压敏胶、聚烯烃热熔胶、功能涂料等产品的研发和生产型企业, 为客户提供全套的热熔胶应用和涂层的解决方案。产品全部通过了环境标志产品认证、ISO9001-2015、ISO14001-2015、IATF 16949-2016 体系认证。

### 主要展品 /Products

聚氨酯热熔胶是以聚氨酯树脂或预聚物为主体材料, 配以各种助剂而制得的一类热熔胶。因含有极性很强、化学活性很高的异氰酸酯基 (-NCO) 和氨基 (-NHCOO-), 与各种材料都有优良的化学粘接力, 且聚氨酯与被粘接材料之间产生的氢键作用会使高分子内聚力增加, 从而粘接更加牢固。1、9860 系列冰箱玻璃门板用胶; 2、3006 系列洗衣机顶盖用胶; 3、9867 系列烟机用胶; 4、EVA 发泡热熔胶。



无锡芯感智半导体有限公司

Wuxi Sencoch Semiconductor Co., Ltd

W3-3A13

地址: 江苏省无锡市滨湖区滴翠路 100 号无锡 (国家) 工业设计园 17 栋 (214000)

Add: Building 17, Wuxi (National) Industrial Design Park, 100 Tricui Road, Binhu District,

Wuxi City, Jiangsu Province

电话 /Tel: 0510-85511607

传真 /Fax: 86-510-85510272

网址 /Web: <http://www.sencoch.com>

公司创立于 2010 年, 下设无锡芯灵微电子、芜湖传方智能、芜湖芯硅智电子三个子公司, 形成从研发设计、封装测试到模组标定的较为完整 MEMS 产业链。

公司已获得 MEMS 专利授权 40 余项, 核心产品涵盖压力、温度、流量、气体四大类传感器, 大多产品处于国内先进水平, 广泛应用于家用电器、医疗电子、汽车电子、消费电子、工业控制、物联网等领域。芯感智不仅在国内拥有众多客户, 产品出口到全球 100 多个国家和地区。

Founded in 2010, the company has three subsidiaries: Wuxi Xinling Microelectronics, Wuhu Chuanfang Intelligent and Wuhu Silicon Smart Electronics, forming a relatively complete MEMS industry chain from R & D, packaging and testing to module calibration. At present, the company has obtained more than 40 MEMS patents, and its core products cover four categories of sensors including pressure, temperature, flow and gas. Most of the products are at the advanced level in China and are widely used in household appliances, medical electronics, automotive electronics, consumer electronics, industrial control, Internet of Things and other fields. We not only have many customers in China, but also export our products to more than 100 countries and regions around the world.

### 主要展品 /Products

公司核心产品涵盖压力传感器、温度传感器、流量传感器、气体传感器。大多产品处于国内先进水平，广泛应用于家用电器、医疗电子、汽车电子、消费电子、工业控制、物联网等领域。

The company's core products cover pressure sensors, temperature sensors, flow sensors, gas sensors. Most of the products are in the domestic advanced level, widely used in household appliances, medical electronics, automotive electronics, consumer electronics, industrial control, Internet of things and other fields.



无锡中微爱芯电子有限公司

WUXI I-CORE ELECTRONICS CO., LTD

W2-2A20 2A21

地址：江苏省无锡市滨湖区建筑西路 777 号无锡国家集成电路设计中心 B4 栋

电话 /Tel: 0510-85572706

网址 /Web: www.i-core.cn

无锡中微爱芯电子有限公司成立于 2004 年，是一家以集成电路设计、测试、应用、方案、销售和服务为主的高新技术企业。中微爱芯拥有完善的 IC 设计系统，拥有 CMOS、BICMOS、BIPOLAR 设计能力。产品已形成 MCU、LCD 显示、LED 显示、通用逻辑、驱动、运放、电源、音响、遥控器、通信、配套等多个系列几百个品种，覆盖消费电子、网通产品、工业设备、新能源、汽车电子等多个领域。

WUXI i-CORE Electronics Co., Ltd. was established in 2004. It is a new high-tech enterprise which focuses on integrated circuit design, testing, application, scheme, sales and service. It is also an integrated circuit design enterprise certified by the Ministry of Industry and Information Technology and within the national planning layout.

i-Core has an experienced team with professional knowledge in IC design. It has a complete IC design system, which is capable in CMOS, BICMOS, and BIPOLAR design. Its products include hundreds of varieties and several series such as MCU, LCD display driver, LED display driver, general purpose logic, driver, amplifier, power supply, audio, remote control, communication, etc., which covers household appliances, Internet of Things, audio and video electronics, automobiles, industrial control, communications and other fields.

### 主要展品 /Products

芯片：MCU、LCD 显示、LED 显示、通用逻辑、驱动、运放、电源、音响、遥控器、通信、配套  
IC: MCU, LCD display driver, LED display driver, general purpose logic, driver, amplifier, power supply, audio, remote control, communication, etc.



芜湖艾尔达科技有限责任公司

Wuhu Aldoc Technology Co., Ltd

N3-3A33 3A34

地址：安徽省芜湖市弋江区花津南路 103 号三花工业园 (241000)

Add: 103huajin South Road, Yijiang District, WUHU City, CHINA

电话 /Tel: 86-0553-2715093-846

传真 /Fax: 86-0553-2715093-835

网址 /Web: www.aldoctech.com

芜湖艾尔达科技有限责任公司是一家从事节能、极速、纳米薄膜、面状电加热技术的创新科技企业。公司专注研究、开发和生产高能效的极速节能电热膜元件、加热模组及电器产品，致力于传统电器产品的加热系统，在电热转换效能、即时快速、方便和节能方面的提升和创新，为国内外家电、个人护理、水加热电器，半导体等企业提供技术和产品解决方案。

Wuhu Aldoc Technology Co., Ltd. is specialized in energy efficient nano-deposited thin-film instant heating technology and its application in instant-on appliances. We provide proprietary standard & customized heater/module in collaboration with client to develop new generation instant-on energy-saving application in household, Semiconductor and water heating appliance.

### 主要展品 /Products

极速电热模组、家用电器

Instant Heating Module, Household Electric Appliances



武汉高德智感科技有限公司

Wuhan Guide Sensmart Tech Co., Ltd

W3-3D113 3D114

地址：湖北省武汉市洪山区光谷大道黄龙山南路 6 号

电话 /Tel: 027-81298779

武汉高德智感科技有限公司成立于 2016 年 11 月，注册资本 6000 万元，是上市公司武汉高德红外股份有限公司 (SZ.002414) 旗下全资子公司，专注于红外热成像技术在民用和新兴领域的应用开发。

高德智感旨在运用开放式的战略思维打造红外“芯”平台，提供人人都能用上的红外应用解决方案，让智能感知提升我们的工作效率和生活品质，让红外科技惠及大众。

### 主要展品 /Products

魔热 MobIR 2 系列红外热成像手机配件

魔热 MobIR 2 系列是高德智感推出的新一代红外热成像手机配件，内置全球首款自动对焦晶圆级红外模组，分辨率更高，性能可媲美专业热像仪。该产品可以让您瞬间拥有肉眼不具备的“超能力”，通过手机 APP 可实现实时测温、夜视、拍照、录像等功能，是您日常工作、家居生活和探险旅行的全能助手。

应用领域：  
家居检测、隐私保护、户外夜视、体温筛查、测评工具、科学研究



武汉灵途传感科技有限公司

WUHAN LINGTU SENSOR TECHNOLOGY CO.LTD

W3-3D119

地址：武汉东湖新技术开发区关东科技工业园七号地块 7-5 幢 4148

电话 /Tel: 027-65525992

灵途科技是一家专注于泛自动驾驶领域光电感知技术的国高新企业，成立于 2017 年，总部位于武汉·中国光谷，在宜昌、苏州、深圳等地设有分支机构，具备从芯片到器件到模组到传感器到行业解决方案的全栈产品研发能力，以光电技术为基础、光电传感器为核心，为行业客户提供器件封装、模组装配、整机设计、解决方案等全方位服务。产品及解决方案已经与智能家居、智慧城市、自动驾驶等领域头部

企业达成合作, 实现应用落地和批量出货。

#### 主要展品 /Products

线激光传感器, TOF 激光雷达, 固态激光雷达, 液态监测传感器, 杀菌传感器, 平层传感器, 互动盒子, 1550nm 光纤激光器, 1550nm 半导体激光器, DTS 光源等光电子器件

## YiliJet

### 武汉亿力电子科技有限公司 Wuhan Yili Electronic Co., Ltd

N2-2A45 2A44

地址: 武汉市东湖高新技术开发区流芳园横路光谷电子工业园 6 栋  
电话 /Tel: 4000278600  
网址 /Web: www.yilijet.com

亿力电子成立于 2007 年, 总部位于有“中国·光谷”之称的武汉东湖高新技术开发区, 是一家专注于数码喷墨控制系统及数码喷墨打印设备的研发、生产与销售的国家高新技术企业。武汉骏图推出了膜片数码彩印机。突破了传统印刷技术瓶颈, 实现了真正意义上的一张起印、无须制版、全彩图像一次完成。数码化的生产方式更环保, 色彩丰富, 效果提升, 是对传统印刷的最好补充, 是传统印刷机的换代产品。

#### 主要展品 /Products

武汉骏图数码膜片卷材 / 片材打印机是一款专门针对家电面板彩色膜片行业所研发的数码喷墨彩色打印机, 可适用于 PC、PET、亚克力, 注塑件、玻璃, 金属铭牌等产品生产。骏图膜片数码彩印机在薄膜开关, 面贴, 注塑等领域均已拥有丰富的工艺方案, 可直接生产加工成型, 也可直接接入 CCD 全自动丝网机配合生产, 可以获得鲜艳的色彩和更平滑的色彩渐变, 降低画面颗粒感, 可满足各种工艺及市场需求。



### 武汉优炜芯科技有限公司 WUHAN UVLEDTEK CO., LTD

W3-3E111

地址: 武汉市东湖新技术开发区华工科技园现代服务业基地 1 号研发楼 B 座 (430068)  
Add: B08, East Lake high tech creative city, Phoenix Road, 9, Wu Tong Hu, Ezhou, Hubei  
电话 /Tel: 15623097174  
传真 /Fax: 027-87971689  
网址 /Web: https://www.uvledtek.com

武汉优炜芯科技有限公司, 专业的紫外 LED 芯片、器件、模组、光源系统及应用方案供应商, 面向全球紫外 LED 方案商和应用公司, 提供高性能近紫外 LED 固化光源系统与装备、高质量深紫外 LED 芯片 / 灯珠 / 模组与服务, 以卓越的科技创新能力打造丰富的紫外行业解决方案, 构建开放共赢的产品生态, 推动产业规范建设, 助力胶水、涂料、油墨紫外固化及医疗美容、植物工厂照明、空气、水、表面杀菌等各行各业实现产业化升级。

Wuhan Youweixin Technology Co., Ltd., a professional supplier of ultraviolet LED chips, devices, modules, light source systems and application solutions, provides high-performance near-ultraviolet LED curing light source systems and equipment, high-quality deep ultraviolet LED chips/lamp beads/modules and services for global ultraviolet LED solution providers and application companies, creates rich ultraviolet industry solutions with excellent scientific and

technological innovation capabilities, builds an open and win-win product ecology, promotes the construction of industrial norms, and helps glue, coating, ink ultraviolet curing and medical cosmetology, plant factory lighting, air, water, surface sterilization and other industries to achieve industrial upgrading.

#### 主要展品 /Products

深紫外 UVC-LED 光源及模组  
Deep ultraviolet UVC-LED module



### 西屋电气公司 Westinghouse Electric Corporation

W3-3F11

地址: 浙江省宁波市海曙区众创空间 6 号楼 3-1 (315000)  
电话 /Tel: 057487623026  
传真 /Fax: 057487623026  
网址 /Web: www.westinghouse.cn

1886 年, 西屋电气公司 (Westinghouse Electric Corporation), 由乔治·威斯汀豪斯在美国宾夕法尼亚州创立。130 余年来, 西屋始终专注于家电、核电、电机、环境保护等领域, 有着丰富的专业研发和制造经验。现今, 西屋积极拓展智能化家电领域, 以技术为底蕴、创新为利刃、品质为保障, 成为消费者眼中“创新产品引领优质生活”的代名词。

#### 主要展品 /Products

冰箱 洗衣机 空调 嵌入式厨电 整体卫浴 会议平板 厨房小家电 热水器 中央净水 中央新风 生活电器 个人防护 中低压工业电气 运动器材



### 夏普科技 (深圳) 有限公司 Sharp Tech (Shenzhen) Co., Ltd

W4-4E21

地址: 广东省深圳市龙华区东环二路二号富士康科技园 A2 栋  
电话 /Tel: 18688892351

中国夏普已能为顾客提供包括液晶电视产品、健康家电产品 (包括冰箱、洗衣机、空气净化器以及小家电等)、办公设备 (数码复合机、传真机、商用净化器等)、商业解决方案 (专业液晶显示器、商用液晶电视、投影机、微生物监测仪等) 以及电子零部件等品种丰富的产品。

#### 主要展品 /Products

电视、显示器、投影机、空气净化器、冰箱、洗衣机、空气净化器、厨房用品等产品



BRI  
呼博士

厦门呼博士智能健康科技股份有限公司  
Xiamen BRI Environmental Industry Co., Ltd.

W2-2C61

地址: 福建省厦门市同安区马垵路 30 号

电话 /Tel: 400-100-5582

网址 /Web: www.bri.com.cn

呼博士成立于 2000 年, 隶属于上市公司大健康品牌企业奥佳华集团 (股票代码: 002614.SZ)。作为一家专业提供室内新风系统及空气净化解决方案的高新技术企业, 呼博士秉承“引领呼吸健康”的企业使命, 现已拥有近百项杀毒检测认证和 40 余项新风专利技术, 主导参编多项国家及地方新风行业标准制定、产品出口全球 60+ 国家、拥有 1500+ 经销商服务网点, 致力为用户的每一个空间场景带来专属的空气健康解决方案。

## 主要展品 /Products

呼博士通过“让科技创造多元, 用舒适升级体验, 以健康焕新生活”的品牌理念, 联合全球顶尖科研机构, 让科研成果为产品聚势赋能。企业所生产的产品包含杀毒新风系列、空净消杀系列等, 拥有卫健委颁发的“消字号认证”。运用 BRI iHunter 杀毒技术做到空气高效消毒净化, 细菌病毒灭杀率 >99.9%, 为用户带来更智能、健康、舒适的全新呼吸体验。

## PUMTEK

金升泵电子科技

厦门金升泵电子科技有限公司  
Xiamen Pumtek Electronics Technology Co., Ltd.

E1-1A20 1A21

地址: 中国福建省厦门市集美区日新路 2 号之 1 第 2 栋 (361022)

Add: Building #2.1-2 Rixin Rd, Xinglin, Jimei, Xiamen, Fujian, China

电话 /Tel: 0592-7612795

传真 /Fax: 0592-7621976

网址 /Web: http://www.pumtek.cn

厦门金升泵电子科技有限公司成立于 2011 年, 是一家致力于精密泵浦和精密电磁阀的国家级高新技术企业, 专业研发和生产各类精密微型气泵、微型真空泵、微型水泵、微型电磁泵、微型电磁阀、线圈部品等产品。产品主要应用于电子血压计、监护仪、咖啡机、吸奶器、按摩器、飘香机、分析仪、饮水机医疗器材、按摩器械、美容美体器材、家用电器、汽车电子、自动化设备等领域产品。

Xiamen Pumtek Electronic Technology Co., Ltd was founded in 2011, we are a precision pump and precision solenoid valve manufacturer which has already gotten China National Hi-tech certification. We professionally develop mini-size air pump, vacuum pump, water pump, electromagnetic pump, mini solenoid valve, coils etc. which application in electro sphygmomanometer, medical monitor, coffee machine, breast pump, massage machine, Analyzer, drink machine, automotive electronic and automation equipment etc.

## 主要展品 /Products

微型气泵、微型真空泵、微型水泵、微型电磁阀等产品。

mini-size air pump, vacuum pump, water pump, mini solenoid valve etc.



厦门科际精密器材有限公司  
Xiamen Koge Micro Tech Co., Ltd

E1-1A43 1A44

地址: 厦门海沧区新阳工业区后祥南路 89 号 (361026)

Add: No.89 South HouXiang Road, HaiCang XinYang Industrial Zone, Xiamen City, China

电话 /Tel: 13459222632

网址 /Web: www.koge.com

公司于 1978 年创立于台湾台北并在厦门市海沧设立工厂, 为全球最大微型隔膜泵生产制造商之一产品广泛应用于检测分析、医疗美容器材、智能卫浴、汽车与家电用品等产业。

除了以 KOGE 自有品牌营销全球, 科际亦提供 OEM/ODM 服务。

已取得多国专利并通过 ISO9001、ISO14001 及 IATF16949 合格认证, 产品营销国际。

在台湾总公司和厦门生产基地拥有近 800 名员工。

KOGE MICRO TECH. located in Taipei, Taiwan, was found in 1978. On the side, Koge build up its owned factory in Haicang, Xiamen City, Fujian province.

Products are widely used in fuel cell, energy environmental protection, environmental monitoring, detection analysis, health care, medical devices, automotive parts and household devices etc.

Koge does not only sell with its own brand but also supply OEM/ODM service.

Certificates we have are ISO9001, ISO14001, and IATF16949.

Nearly 800 staff in Taiwan headquarters and mainland factory.

## 主要展品 /Products

主要生产各种微型精密泵如: 气泵、真空泵、水泵及电磁泵等, 阀类如: 单通阀、二通阀、并联阀、线性阀及电磁阀等

For products, Koge is specialized in mini pump and valve, including air pump, vacuum pump, water pump, electromagnetic pump and kinds of solenoid valve. Those are widely used in fuel cell, energy environmental protection, environmental monitoring, detection analysis, health care, medical devices, automotive parts and household devices etc.

## CASTEC

厦门科司特电子工业有限公司  
Xiamen Castec Electronic Industry Co., Ltd.

W5-5A26

地址: 福建省厦门市同安区西柯街道美溪道思明工业园 46 号

电话 /Tel: 05923569888

网址 /Web: www.xmcastec.com

厦门科司特是一家集研发、制造及销售为一体的国家高新技术电源系统制造企业, 注册资本 1.6 亿元, 专业专业提供开关电源管理方案及电子产品制造服务。主营产品有智能控制板、雷达传感器、高/低功率电源、储能电源等系列产品。拥有 3 家控股子公司, 建立厦门、深圳、惠州三大研发中心及厦门、贵州、甘肃三大生产基地。

科司特通过持续创新和对高品质的不懈追求, 获得了客户的一致认可和充分信任, 是电源行业极具实力的供应商。

## 主要展品 /Products

智能控制板、雷达模块、敲击模块、无线供电、电动牙刷、电源适配器、PD 电源、不间断电源



厦门坤锦电子科技有限公司

**Xiamen Conjoin Electronics Technology Co., Ltd.**

地址: 福建省厦门市集美区灌口后山头路 28 号

Add: No.28, Houshantou Road, Guankou, Jimei District, Xiamen, Fujian

电话 /Tel: 0592-6216677

传真 /Fax: 0592-6219977

网址 /Web: www.conjoin.com.cn

厦门坤锦电子科技有限公司是一家集研发、制造、销售和服务为一体的外资高新技术企业, 主营产品涵盖压力泵、真空泵、液泵、电磁阀等各类精密流体控制产品, 广泛应用于汽车座椅、医疗、家电、环境监测、工业能源等领域。占地 18000 平方米的现代智能化厂区, 拥有完善的开发系统以及先进的制造和检测设备; 制造流程严格依照 ISO9001、ISO14001、TS16949 管理体系进行。

Xiamen Conjoin Electronics Technology Co., Ltd (Conjoin for short) is a high-tech enterprise with invention patent and utility patent, integrating R&D, manufacturing, marketing and service. Conjoin specializes in various precision fluid-control products, such as mini pump and valve, which are widely applied to medical equipments, healthcare equipments, automobile massage seat, household electric appliances, energy, environmental protection, etc. Since its establishment, Conjoin sets up a clear self-positioning, that is, to be a respectable expert and key player in the industry. And Conjoin is always striving for that by means of scientific research, R&D innovation, management system, professional operation and attentive service. Indeed, Conjoin is making progress to win more and more recognition.

#### 主要展品 /Products

旋转隔膜压力泵, 旋转隔膜真空泵, 旋转隔膜水泵, 蠕动泵, 电磁阀

Rolling diaphragm pressure pump, rolling diaphragm vacuum pump, rolling diaphragm water pump, peristaltic pump, solenoid valve

**SET safe | SET fuse**

厦门赛尔特电子有限公司

**Xiamen SET Electronics Co., Ltd.**

地址: 福建省厦门市翔安火炬高新区翔安西路 8001、8067 号 (361100)

电话 /Tel: 0592-5715838

传真 /Fax: 0592-5715839

网址 /Web: http://www.setfuse.com

赛尔特制造过温、过压、过流保护元器件厂家。拥有 22 年创新的历史, 产品取得 CCC、UL、cUL、VDE、TUV、PSE、KC 认证, 符合 RoHS、REACH。主要应用于通信领域、防雷领域、照明领域、光通讯领域、工业、民用电源、家用电器、电机。

赛尔特拥有美国 UL 授权的 UL 1449, UL 60691 标准目击测试实验室 (WTDP), 产品销往 40 多个国家和地区, 与世界 500 强的部分企业有深远的合作。

SETsafe | SETfuse was established in 2000 in Xiamen, China. We have a presence in more than 40 countries recognising our products. Some of the world's 500 fortune companies are our valuable customers. We have pioneered, innovated & developed several products exclusively. Products are compliance with CCC, UL, cUL, VDE, TUV, PSE, KC, IATF 16949, ISO 9001, ISO

14001, ISO 45001, RoHS, REACH certificates. We are in one of the core participating teams for revising and setting several national & international standards in the field of Circuit Protection.

#### 主要展品 /Products

温度保险丝、压敏电阻、电流保险丝、热保护型压敏电阻、温控器、NTC、GDT 等电子元器件

**拙雅**  
JOYADESIGN

厦门市拙雅工业设计有限公司

**Xia Men Joyatech Co., Ltd.**

地址: 厦门市思明区软件园二期观日路 28 号 304

电话 /Tel: 0592-2950100

厦门市拙雅科技有限公司创立于 2003 年, 是工信部认定的国家级工业设计中心。公司运用设计思维、方法论, 提供服务、策略、资源与中国和全球客户合作; 以人的需求为本, 帮助客户实现产品创新、品牌重塑和商业价值提升; 以科技为手段, 将加速发展的技术进步与人的需求对接, 应用于产品创新、提升用户体验; 以商业成功为目的, 将商业策划与品牌策划、视觉传达和产品设计相结合, 帮助初创企业起步、小型企业发展、大型企业创新。

#### 主要展品 /Products

设计研究: 用户调研、趋势分析等; 设计策划: 产品定位、产品线策划等; 设计传达: 产品造型、结构设计等; 设计实现: POC 样机开发、供应链资源整合

**VORK**

厦门唯科健康产业有限公司

**Xiamen Vork Health Industry Co., Ltd.**

Add: No.16, Xianghong Road, Xiang'an (361101)

电话 /Tel: 15359211530

网址 /Web: http://www.vorktech.com/

唯科健康产业是国内一流模具制造企业唯科科技集团旗下子公司, 注册资本 5500 万元人民币。主要从事健康家电产品创新研发、生产、销售、服务一体化的高科技企业。公司致力于以创新、节能、环保和质量为理念, 提供高品质产品。公司主要产品包括空气净化器、净水器、即热饮水机、咖啡机、加湿器、厨房小家电、医疗产品和其他健康产品, 致力于为消费者带来高品质的健康产品和改善生活体验, 共同创造优质生活。

VORK Health is a high-tech enterprise that is mainly engaged in the integration of innovative R&D, production, sales, and service of health products. The corporate is dedicated to providing high quality products for better living experiences with philosophy of innovation, energy saving, environmental protection and quality. The company is backup on the strong financial support of VORK Group, first-class R&D capability, German-standard production and manufacturing platforms, and multi-disciplinary technical team support. It has standardized water quality monitoring and analysis laboratories, filter production lines, and clean workshops. Our main product range is including water filters, air purifiers, humidifiers, medical products and other health products and services, is committed to bring consumers the high quality of health products and improve living experience, together to create a good quality life.

**主要展品 / Products**

家用电器制造商和解决方案提供商

环境家电、空气净化器、加湿器、吸尘器、风扇、个护家电、美容仪、头梳、美容镜、吹风机、厨房家电、咖啡机、即热饮水机、烤箱、垃圾处理器、电磁炉、净水器、净水壶

Environment Appliance

Airpurifier, Fans, Humidifier, Vacuum Cleaner, Electric mop, Kitchen Products, Coffee Maker, Heat Induction cooker, Food disposal Processor, Steam Oven, Quick Heater, Beauty care, Skin treatment, LED Mirror, Shaver, Anion Comb, Water filter system, Pitcher, RO/UF filter, Outdoor fit

**CHIPSUN**

芯阳科技

厦门芯阳科技股份有限公司

**E1-1A25 1A26**

Xiamen Chipsun Science &amp; Technology Co., Ltd.

地址: 厦门市同安区同安工业集中区思明园 46 号 (361100)

电话 /Tel: 0592-6535166

传真 /Fax: 0592-5827803

网址 /Web: <http://www.chipsun.com/>

厦门芯阳 2003 年 4 月创建于福建省厦门市, 公司以集成电路设计为核心, 以智能控制器方案开发为依托, 以现代化生产制造为基础, 是集设计开发、应用、生产和销售为一体的高新技术企业。

以“领航控制产业, 改善民众生活”为企业使命, 发扬“敬天爱人, 追求卓越, 令人尊重”的经营理念, 用智慧把握未来, 用科技铸造辉煌, 用产品服务全球, 实现行业共同进步、客户共同成功的双赢前景, 永做令人尊敬的企业。

Chipsun is a company:

Takes IC design as the core, Dedicates to development of Smart Controller PCBA solutions, Relies on modernized production, Integrates design, development, manufacturing and sales together, National level Hi-Tech corporation.

**JOYE 越一**

厦门越一电子科技有限公司

**E2-2D61**

地址: 厦门市集美区灌口镇三社路 518 号

电话 /Tel: 0592-5784949

厦门越一电子科技有限公司成立于 2009 年, 注册资金: 1000 万, 是一家集设计、研发、制造、销售、服务为一体的智能健康电器制造企业。

公司前身专注于生产出口欧盟的商用大功率电器二十余年, 在电器制造上积累了强大的研发、制造能力与高标准的质量控制和管理水平。越一凭借优良品质与先进技术, 已获 100 余项国家发明专利和实用新型专利授权; 已获得国家 ISO9001 质量管理体系认证与“国家高新技术企业认证”等荣誉称号

**主要展品 / Products**

越一致力于在烧水电器行业持续研发和创新, 以用户体验与健康生活为核心, 将烧水电器融入茶室、家居、办公等场景。在当下智能时代, 研发出互联网 + 烧水系列、全智能烧水系列、开盖除氯烧水系列等智能烧水壶。

ShowSee  
小适**小适****E3-3E11****showsee**

地址: 浙江省宁波市慈溪市白沙路街道 515 号浪木大厦 21F (315300)

电话 /Tel: 4008922882

传真 /Fax: 0574-63028173

网址 /Web: [www.showsee.com](http://www.showsee.com)

小适 (showsee) 成立于 2019 年 10 月, 月立集团孵化的综合个护小家电品牌, 主营个人护理消费电子产品的研发、生产、销售一体化服务。小适, 寓意小而精致、美而舒适, 依托总部月立集团 26 年供应链大牌智造实力, 拥有 606 项专利的研发团队, 与年轻消费者适新共创。旗下产品包含美发护理类的电吹风、卷直发器; 口腔护理类的电动牙刷、冲牙器; 仪容护理类的电动剃须刀、鼻毛修剪器、理发器、修足器、磨甲器及相关配件。

SHOWSEE, founded in October 2019, is an integrated personal care and consumer electronics brand, specializing in the development, production and sales of personal care products. Xiaoshi, small and delicate, beautiful and comfortable, relying on the headquarters of Yueli Group 26 years of supply chain, with 606 Patents R & D team, and young consumers to create new. Our products include hair dryer, hair straightener, oral care electric toothbrush, tooth Washer, facial care electric shaver, nose hair trimmer, hair trimmer, foot trimmer, nail polisher and related accessories.

**主要展品 / Products**

美发护理类的电吹风、卷直发器;

口腔护理类的电动牙刷、电动冲牙器;

仪容护理类的电动剃须刀 (旋转式三刀头)、鼻毛修剪器、理发器、修足器、磨甲器及相关配件。

Hair care type hair dryer, curly hair straightener;

oral care type of Electric Toothbrush, electric toothbrush;

Facial Care Electric Shaver (rotary three-blade), nose hair trimmer, hairdresser, foot trimmer, nail polisher and related accessories.

**小卫 SIMPLEWAY****小卫****E3-3E83****simpleway**

地址: 上海市宝山区滬星路 1933 号 1 幢 1 号

电话 /Tel: 021-61641108

小卫科技拥有 3000+ 平米研发中心及核心供应链园区, 专注于【日用消费品 + 智能硬件】的跨界创新, 将先进的智能科技完美融入传统的日化产品, 重新定义智能时代下的生活方式。未来小卫科技将持续探索在互联网时代, 传统日化产品与智能硬件、IoT、传感技术、大数据等结合的机会, 推出更多行业领先的新概念日化产品。10000m<sup>2</sup> 生产车间, 10 + 供应链, 打造核心供应链, 提升效率。

**主要展品 / Products**

智能感应洗手液, 香氛机, 香氛杯, 自动泡沫洁面机



## 小熊电器股份有限公司

### The Bear Electric Appliance Co., Ltd.

E2-2F11

地址: 广东省佛山市顺德区勒流街道富安工业区富兴路 3 号小熊智能园 (528322)

Add: The Bear Intelligent Park, No. 3, Fuxing Road, Fu'an Industrial Zone, Leliu street, Shunde

District, Foshan City, Guangdong Province

电话 /Tel: 4006622580

传真 /Fax: 0757-23663265

网址 /Web: <https://www.bears.com.cn/>

小熊电器成立于 2006 年 3 月, 是一家以自主品牌“小熊”为核心, 运用互联网大数据进行创意小家电研发、设计、生产和销售的实业型企业。多年来, 凭借个性化的产品设计、丰富的产品线及卓越的营销模式, 小熊电器一直保持快速、稳健的发展, 2019 年正式在深交所挂牌上市 (股票代码: 002959), 并获得“中国驰名商标”、“国家级工业设计中心”等多项荣誉, 收获亿万年轻用户的信赖, 成为年轻人喜欢的小家电品牌。

Bear Electric Appliance was founded in March 2006. Independent brand “Bear” is its core and main brand. Based on Internet big data, Bear Electric Appliance is an enterprise committed to researching & development, design, manufacture and sales of innovative small home appliance. Bear Electric Appliance has maintained rapid and steady development for years due to personalized product design, various product lines and excellent marketing mode. It was officially listed on the Shenzhen Stock Exchange in 2019 (stock code: 002959), and has won the support and trust of hundreds of millions of young users. “Bear” is a famous brand of small home appliance loved by young people.

#### 主要展品 /Products

目前公司拥有 60 多个产品品类, 超过 500 款型号产品, 涵盖厨房电器、家用电器、家居产品、个人护理、户外产品、母婴用品等。

At present, the company has more than 60 product categories and more than 500 models of products which covers kitchen appliances, household appliances, home products, personal care, Outdoor products, maternal and child products, etc.

## 肖特玻璃科技 (苏州) 有限公司

### SCHOTT Glass Technologies (Suzhou) Co., Ltd.

N1-1E21

地址: 江苏省苏州市高新区火炬路 79 号 (215009)

Add: No.79 Huoju Road, Suzhou New District China

电话 /Tel: 0512-68095989

传真 /Fax: 0512-66902225

网址 /Web: [www.schott-ceran.com](http://www.schott-ceran.com)

肖特赛兰® 是德国肖特集团公司的注册品牌。1971 年, 肖特赛兰® 推出了第一款黑色微晶玻璃灶具面板, 从而开启了全新的烹饪时代。肖特赛兰® 是全球最畅销的灶具面板品牌之一。肖特赛兰® 微晶玻璃灶具面板书写了一个成功的故事, 代表了历史传承、优异质量和不断创新。肖特赛兰® 为我们的厨房带来了高端技术和精致设计。除了众多的知名奖项以外, 肖特赛兰® 还获得了第三方检验机

构的官方认证, 这无疑证明了产品的高品质。

SCHOTT CERAN® is a registered brand of SCHOTT AG.

In 1971, SCHOTT CERAN® introduced the first black glass-ceramic cooktop panels and a new global era in cooking has begun. Over 180 million Originals sold make SCHOTT CERAN® the world's best-selling cooktop panel brand.

SCHOTT CERAN® glass-ceramic cooktop panels are writing a success story that stands for tradition, quality and innovation. SCHOTT CERAN® brings high-end technology and sophisticated design to any kitchen.

Besides the many renowned awards, SCHOTT CERAN® has received the official seals and certificates from neutral inspection agencies clearly prove the high quality of the

#### 主要展品 /Products

无论是辐热炉、电磁炉还是燃气灶, 肖特赛兰® 都能提供恰当的解决方案。

肖特赛兰® 提供黑色、透明和白色三种微晶玻璃材料, 以及几千种装饰图案和颜色组合。全球 600 多位科学家的不断探索创造了 160 多组专利。肖特的新型微晶玻璃 CERAN Luminor™ 让灶台更明亮、更直观和更多彩。该材料透白光的性能是常规黑色微晶玻璃的 5 倍, 属行业首创也是迄今的唯一。

regardless of whether you use radiant, induction or gas – SCHOTT CERAN® offers just the right solution for every cooking technology and a variety of design possibilities.

SCHOTT CERAN® glass-ceramic is available in black, transparent and white. Today, 1,000 different decorative variations and around 5,000 different color combinations are possible.

Fascinated by glass, over 600 scientists worldwide do research on it and constantly discover new sides to this truly unique material. This insight has resulted in more than 160 additional patent families.

The new SCHOTT CERAN Luminor™ glass-ceramic product brings bright, clear and true-color lighting solutions to cooktops.

The material is the first and only material of its kind.

It lets white light shine through 5 times brighter than standard black glass-ceramic.

## 肖特集团平板玻璃事业部

### SCHOTT AG Flat Glass

N1-1C31

地址: 苏州新区科技工业园, 火炬路 79 号 (215009)

Add: No. 79, Huoju Road, Suzhou New District Suzhou, 215009 China

电话 /Tel: 051268095989

网址 /Web: <https://www.schott.com/en-gb/flat-glass>

肖特平板玻璃是家电用深加工玻璃的市场领导者和技术专家, 隶属于肖特集团。而肖特集团拥有特种玻璃领域超过 130 年的专业经验, 总部位于德国。

我们致力于研发, 制造和销售用于烤箱, 燃气灶, 烟机, 洗碗机, 冰箱, 洗衣机及其他家用电器产品的深加工玻璃, 并通过位于全球 6 个国家的工厂和研发基地, 为家电行业源源不断地提供专业技术和产品创新。

SCHOTT Flat Glass, the market leader and worldwide expert for processed glasses for home appliance applications, is part of SCHOTT AG, the global technology group with over 130 years in specialty glass and headquarter in Germany.



We develop, produce and market processed glasses for baking ovens, gas cooktops, extractor hoods, refrigerators, washing machines, dishwashers and other applications in the home. We work with a production and R&D network in 6 countries and provide longstanding technical expertise and innovation to the Home Appliance industry.

#### 主要展品 /Products

- 烹饪: 灶具和烟机面板
- 烘焙: 烤箱门体玻璃和控制面板
- 洗碗机: 门体玻璃和控制面板
- 热水器 / 采暖炉: 装饰面板
- 洗衣机: 玻璃盖板
- 厨房电器用全套系玻璃面板
- Cooking: cooker top and hood glasses
- Baking: outer and inner oven door glasses and control panels
- Dishwashing: door glasses and control panels
- Water heaters/boiler: front glasses
- Washing machine: glass lids
- Matching designs for product family lines across all kitchen appliances
- Various innovations design & function wise



#### 新乡市杰达精密电子器件有限公司 Xinxiang Jieda Precision Electronics Co., Ltd.

E2-2B14

地址: 新乡市新飞大道 1789 号高新区火炬园  
电话 /Tel: 18603734708

新乡市杰达精密电子器件有限公司坐落于国家级卫生城市新乡市新飞大道南段高新区火炬园, 交通便利。公司以不锈钢厚膜加热技术为主导, 是一家集产品研发、生产制造、销售服务为一体的技术企业。杰达率先在国内研发出“不锈钢厚膜加热管”, 该技术国内首创, 世界领先, 可广泛应用于家用电器(即热式电热水龙头、即热式电热水器、开水机、咖啡机等)、工业蒸汽发生器、流体管道保温等领域。目前客户主要为欧美及国内知名大公司。

#### 主要展品 /Products

不锈钢厚膜加热管, 厚膜加热体, 厚膜加热板, 蒸汽加热体, 净水加热模组。



#### 星辉电业(东莞)有限公司

N4-4B12-4

地址: 广东省东莞市长安镇乌沙社区步步高大道 213-2 号  
电话 /Tel: 0769-85543987

星辉电业(东莞)有限公司专业生产各类滑动开关、翘板开关、微动开关、旋转开关、拨动开关和汽车开关。产品均通过 UL、C-UL、ENEC、CQC 认证。应用于家电、厨具、医疗仪器和汽车行业, 热销国内外大品牌产品。

Sing Fai Electric (Dongguan) Co. Ltd. specializes in the manufacture of appliances switches as: Slide Switch, Micro Switch, Push Button Switch, Rotary Switch, Rocker Switch and Automotive Switch. The company has been committed in providing high quality reliable switches for home appliances, kitchenware products, medical devices and automobiles. Switches were approved in UL, C-UL, ENEC & CQC safety standards, severing worldwide well known big brand products.

#### 主要展品 /Products

滑动开关、翘板开关、微动开关、旋转开关、拨动开关和汽车开关



正民磁电集团  
ZHENGMIN GROUP CO., LTD

#### 徐州通用高新磁电有限公司 Xuzhou general hi tech magnetolectric Co., Ltd

W1-1A41

地址: 江苏省徐州市贾汪区青山泉工业园  
电话 /Tel: 17312855598

是国内第一家研制生产永磁电机转子的公司。广泛应用于洗衣机、空调、洗碗机、厨电、厨卫、冰箱、小家电、汽车、水族用品等领域。

已成为全球规模最大的永磁转子制造商, 在江苏、广东、安徽布局五大生产基地  
建有国家级磁性材料联合研究中心, 江苏省永磁电机转子工程技术研究中心, 拥有永磁电机转子核心专利 30 余件  
型号有 1300 多种, 年产永磁转子 2 亿多件  
获得 GE、伊莱克斯、三星、西门子、LG、惠而浦、博世企业的认可



#### 渲美美健(深圳)科技股份有限公司

E3-3C81

地址: 广东省深圳市南山区海德三道 195 号 天利中央商务广场 B 座 29 楼 (518000)  
电话 /Tel: 0755-33662222  
传真 /Fax: 0755-33662222  
网址 /Web: www.touchbeauty.com.cn

TOUCHBeauty 渲美诞生于 1999 年, 专注并致力于个人护理美容仪产品的创意、设计、研发、销售及全球品牌运营。渲美以优秀的产品, 卓越的品质, 励精图治 24 年, 开创了个人护理美容仪行业的先河。目前渲美品牌及产品遍及全球 80 多个发达国家及发展中国家和地区, 形成线下航空免税店、品牌店、百货店、电器店、药妆店、时尚用品连锁店, 线上第三方平台品牌店、加盟店、连锁店及官方独立店等全面发展的立体营销网络。

#### 主要展品 /Products

渲美致力于自然美的探索和研究, 研发出满足消费者从早到晚、从头到脚、丰富多样的个人护理美容仪全品类, 包含美容仪器、理容工具、健发工具、美体工具、手足工具、男士理容 6 大产品系列, 实现消费者由身及心的美与自信。优秀的产品质量使渲美摘得了日本企业颁发的产品不良率低于 0.2% 的认证桂冠; 时尚的产品工业设计荣获多项世界领域大奖。有一种美, 由表及里; 有一种爱, 由内而外。爱懂美, 用渲美!

**XUNDA**  **迅达厨电**  
品质厨房科技厨电

**迅达科技集团股份有限公司**

**Xunda Science & Technology Group Co., Ltd.,**

地址: 湖南省湘潭市高新区通达大道迅达工业园 (411101)

电话 /Tel: 0731-55188858

传真 /Fax: 0731-55188858

网址 /Web: <http://www.xundaco.com/>

#### 一、公司基本情况

迅达科技集团股份有限公司始创于1984年,是一家专注燃气具产品研发生产销售的股份制企业,建立有迅达湖南科技园、湖北可再生能源产业园二大产业园区,现拥有员工近1600人,是中国燃气用具行业十强企业、中国燃气灶具十强企业。

公司主要产品有燃气灶具、燃气热水器、吸油烟机、电热水器、消毒柜、蒸烤一体机、洗碗机、烤箱、集成灶等。迅达产品销往欧美、中东、非洲等80多个国家和地区。

Xunda Science & Technology Group Co., Ltd., established in 1984, is a joint stock enterprise focusing on production of gas appliances. Now, it has such two industrial parks as Xunda Hunan Scientific Park and Hubei Renewable Energy Industrial Park, covering an area of 720 acre. Now, Xunda, which has 2,100 employees, is a top 10 gas appliance company in China.

Its products can be divided into four series – gas appliances, kitchen and bathroom electric appliances, integrated kitchens and new energy application products. The company has the following main products: gas stoves, gas water heaters, range hoods, electric water heaters, disinfection cabinets, ovens, integrated kitchens, biomass boilers, biomass stoves, methane stoves, methane water heaters, methane purification regulators and auxiliary methane pipe fittings, etc.

"Xunda" brand is registered in 44 countries and "Xunda" products have been sold to over 80 countries and regions in West Countries, Middle East and Africa.

#### 主要展品 /Products

公司主要产品有燃气灶具、燃气热水器、吸油烟机、电热水器、消毒柜、蒸烤一体机、洗碗机、烤箱、集成灶等。

Its products can be divided into four series – gas appliances, kitchen and bathroom electric appliances, integrated kitchens and new energy application products. The company has the following main products: gas stoves, gas water heaters, range hoods, electric water heaters, disinfection cabinets, ovens, integrated kitchens, biomass boilers, biomass stoves, methane stoves, methane water heaters, methane purification regulators and auxiliary methane pipe fittings, etc.

#### JACOB JENSEN DESIGN

#### 雅各布延森设计

**Jacob Jensen Design**

地址: 上海市长宁区平武路80号304、305室 (200052)

Add: Pingwu Road 80, 304 & 305, Changning District, Shanghai, PRC 200052

电话 /Tel: 18200895346

网址 /Web: [www.jacobjensen.cn](http://www.jacobjensen.cn)

**N1-1C71**

## 参展商名录 (按字母排序) / Alphabetical List of Exhibitors

雅各布延森设计于1958年由工业设计大师-雅各布·延森在丹麦创立,是斯堪的纳维亚地区最早成立的设计咨询公司之一。六十多年来,通过不断深化与完善设计准则,我们创造出了众多意义非凡和具有突破性的设计,独树一帜、引领潮流。我们在欧洲、中国和泰国均设有办事处,是一支致力于将调研、策略、设计、洞察力、科技、工程与以人为本的需求有机融合的专家团队。

JACOB JENSEN DESIGN

At Jacob Jensen Design, we support companies in their journey to adapt, evolve and succeed in their own field.

We are one of Scandinavia's first design consultancies, established in Denmark in 1958 by one of the great Danish design masters, Jacob Jensen. For more than six decades we have perfected our design methodology to deliver meaningful and groundbreaking designs with exceptional enduring appeal.

With offices in Europe, China and Thailand, we are a team of experts specialised in combining research, strategy, design, insights, technology and engineering with human centric needs.

#### 主要展品 /Products

科沃斯邀请雅各布延森设计共同定义了行业第一台全能的扫拖机器人,为地宝X1家族带来了真正的北欧极简主义设计。地宝X1家族以“未来自动驾驶电动汽车设计”为灵感,参考符合空气动力学的出风口,顶部隆起的“肌肉棱线”暗示其强大功能;金属质感的机身充满着未来科技感的同时,完美融入高端家居氛围;整体采用经典银+黑对比配色,赋予了产品极致的科技感与神秘感。雅各布延森设计的极简简约设计赋予地宝X1家居艺术品之名。



扬州爱斯派电器有限公司  
ASPRIANT

**扬州爱斯派电器有限公司**

**Yangzhou Aspriant Electric Appliance Co.,Ltd**

地址: 江苏省宝应县城南集中工业区淮江大道2号 (225800)

Add: 2 Huaijiang Road, Southern Industrial Park, Baoying county, Jiangsu province China

电话 /Tel: 18796687918

传真 /Fax: 0514-88987501

网址 /Web: [www.engfee.com](http://www.engfee.com)

**N1-1B46**

扬州爱斯派电器有限公司是集研发、设计、生产、销售一体的专业 PTC 器件制造厂商,优秀团队,先进技术,精良设备,严格的管理使公司不断发展。产品主要应用智能小家电、暖风机,浴霸、新能源汽车等电加热领域。已同国内外多家企业建立长期合作关系,如:美的电器,华帝集团,欧普集团,雷士集团等。公司严格执行 ISO9001: 2015 质量管理体系,坚持以“质量和信誉是利润的源泉”为发展方针,为客户提供更好的产品和服务。

YangZhou Aisipai Electric Co.,Ltd. is a professional PTC device manufacturer integrating R&D, design, production and sales. Excellent team, advanced technology, sophisticated equipment and strict management make the company continue to grow and develop. Products in the market have won the trust of the majority of users. The products are mainly used in the field of electric heating such as smart small household appliances, heaters, Yuba new energy vehicles. The company has established long-term and stable cooperative relations with many well-known enterprises both at home and abroad, such as: Midea Electric, Vantage Group, OUPU Group, NVC Group and so on. The company strictly implements ISO9001: 2015 quality management system, adheres to the development policy of "quality and reputation are the source of profit", and provides customers

with better products and better services. The company aims to "develop domestically and create a world brand" and build a well-known brand that users trust.

#### 主要展品 /Products

产品主要应用于智能小家电、暖风机、浴霸、新能源汽车等电加热领域。

The products are mainly used in the field of electric heating such as smart smallhousehold appliances, heaters, Yuba new energy vehicles.



**BAOZHU**

#### 扬州宝珠电器有限公司

#### Yangzhou Baozhu Electric Appliance Co. LTD

**N1-1B18**

地址：江苏省扬州市宝应县曹坝宝珠工业园 (225800)

Add: Baozhu Industrial Park, Caoba Industrial Zone, Baoying County, Yangzhou, Jiangsu

电话 /Tel: 0514-88360999

传真 /Fax: 0514-88369666

网址 /Web: www.bzdq.cn

宝珠集团拥有三家分公司，占地 100 多亩，年产值 4 亿多元。公司荣获高新技术企业和江苏省民营科技企业，并取得 UL, VDE, CB, CQC, KC, TUV, IATF 16949, 14000, ISO 9001-2015 等相关认证。产品广泛应用于军工、飞机工业、电机、家用电器、锂电池、照明、医疗、汽车、通讯、智能家居等领域。

Baozhu Group has three branches, covering an area of more than 100 mu. Its annual output value is more than 400 million yuan. The company has won the national high-tech enterprises and private science and technology enterprises in Jiangsu Province, and obtained UL, VDE, CB, CQC, KC, TUV, IATF 16949, 14000, ISO 9001-2015 and other related certifications. The products are widely used in military industry, aircraft industry, electrical machinery, household appliances, lithium batteries, lighting, medical, automotive, communications, intelligent home and other fields.

#### 主要展品 /Products

热保护器、温控器、传感器、保险丝

Thermal protectors, Thermostats, Sensors, Fuses



#### 一微半导体

#### Amicro

**W3-3C106**

地址：珠海市横琴新区 ICC 横琴国际商务中心 2 座 27 楼 (519000)

Add: Room 2706, 3000 Huandao East Road, Hengqin New District, Zhuhai City

电话 /Tel: 07562666456

传真 /Fax: 0756-2666456

网址 /Web: http://amicro.com.cn

珠海一微半导体股份有限公司 2014 年成立于横琴，是一家以机器人技术及大规模高集成度数模混合芯片设计为主的国家高新技术企业，拥有数模混合集成电路 (SoC) 设计、机器人算法、机器人开

发平台等多项前沿技术及大规模芯片量产经验，致力于成为全球移动机器人领域核心芯片、核心算法以及系统解决方案的主流技术平台，是移动机器人专用芯片领域的领航者。2022 年，公司成功入选第四批国家级专精特新“小巨人”企业。

Amicro Semiconductor is an innovative high-tech enterprise focusing on robot technology and large scale, high integration, and digital-analog hybrid chip design. Amicro was also rated as a high-tech R&D company, a national high-tech enterprise, an integrated circuit design company, a member unit of the China Service Robot Standards and Technology Industry Alliance. The company is committed to becoming a platform provider for core chips, core algorithms, and system solutions in the global robotics field. Mainly positioned in robotics motion control and positioning navigation (SLAM) dedicated SoC chip design, core algorithm and complete product solutions. The main application areas include cleaning, consumer appliances, service, industry, logistics, etc.

#### 主要展品 /Products

公司致力于成为全球机器人领域核心芯片、核心算法以及系统解决方案的平台供应商。

主要定位在机器人运动控制和定位导航 (SLAM) 专用 SoC 芯片设计、核心算法及完整产品解决方案，主要应用于清洁类、消费类、服务类、工业、物流等多领域。



#### 一芯家科技 (常州) 有限公司

**E1-1H11**

地址：常州市 新北区龙锦路 1590 号现代传媒中心 1 号楼 1801 室

电话 /Tel: 13917061770

网址 /Web: http://www.onepillar.cn/

2021 年，格力博 Greenworks 将全球领先的锂电池技术和无线生态带回中国，创立了全新品牌“一芯家”，深入洞察国内消费者需求，始终把为消费者创造真正的价值作为最核心的内驱力，打造锂电共享产品生态链，和中国家庭共同创造美好生活。一芯家是扎根于家用清洁领域，致力于以新能源创新，打造革命性家电产品的科技公司，围绕核心产品“超级芯”，搭建完整的产品生态矩阵，在家用、车载、户外等多个领域取得技术突破。

#### 主要展品 /Products

超级芯 Core one、吸拖洗烘四合一洗地机 Glam one、无线随手吸尘器 Modern one、大流量无线高压洗车枪 Power one、全自动拖地机器人 Smart one



**伊莱克斯 (中国) 电器有限公司**  
**Electrolux (China) Home Appliance Co., Ltd.**

**N4-4F31**

地址: 上海市静安区共和新路 1968 号大宁国际商业广场 8 座 5 楼 (200072)  
电话 /Tel: 31781000  
传真 /Fax: Electrolux  
网址 /Web: <https://www.electrolux.com.cn/>

伊莱克斯 (Electrolux) 是一家全球领先的家用电器公司, 在 100 多年来, 伊莱克斯一直致力于让生活更美好。我们为数百万消费者重塑美味, 呵护和宜居体验, 并通过我们的解决方案和运营始终努力站在社会可持续发展的前沿。

有关更多信息  
请访问

[www.electroluxgroup.com](http://www.electroluxgroup.com)

Electrolux is a leading global appliance company that has shaped living for the better for more than 100 years.

We reinvent taste, care and wellbeing experiences for millions of people, always striving to be at the forefront of sustainability in society through our solutions and operations.

In 2020 Electrolux had sales of SEK 116 billion and employed 48,000 people around the world. Our headquarters are located in Stockholm, Sweden, and the Electrolux share (ELUXb) is listed on Nasdaq OMX Stockholm.

Under our brands, including Electrolux, AEG and Frigidaire, we sell approximately 60 million household products in over 120 markets every year.

**主要展品 /Products**

白色大家电产品, 嵌入式厨房家电, 独立式厨房电器, 洗护类产品 (洗衣机、干衣机、洗干一体机等), 生活电器, 厨房小家电, 空气净化类产品, 厨房独立电器等



**依哥智能家居有限公司**

**W2-2G71**

地址: 江苏省苏州市吴中区友翔路 34 号 1 幢 (215200)  
电话 /Tel: 19962190357  
传真 /Fax: 0512-65980118  
网址 /Web: [www.yigehome.com.cn](http://www.yigehome.com.cn)

苏州依哥智能家居有限公司, 成立于 2018 年 2 月, 坐落在美丽的苏州湾北岸。我司专注于智能家居的研发与生产, 研发费用占比超公司总投入的 50%, 公司的整体面积超过了 2 万平方米。是一家专业从事智能家居研发 \ 生产 \ 销售的高科技公司。

依哥自主研发的智能柜式干衣机, 是一款全新的科技产品, 本产品利用空气能冷热转换原理, 在常温下实现干衣, 并且通过紫外线杀菌, 臭氧杀菌, 全方位对衣物进行呵护。

**主要展品 /Products**

智能鞋柜, 干衣机



云趣新芽

**依云智酷 (北京) 科技有限公司**

**W3-3B21**

地址: 北京市大兴区亦庄经济技术开发区西环南路 26 号院 22 号楼 1 栋  
电话 /Tel: 18611559137

依云智酷 (北京) 科技有限公司成立于 2016 年 7 月, 位于北京经济技术开发区, 中关村高新技术企业, 国家高新技术企业。公司专注儿童智慧教育领域, 以一台双终端的形式为智慧教育和健康教育提供综合解决方案。

**主要展品 /Products**

云趣新芽触控投影是国内首款具有任意平面可触控、高清投影、AI 语音智能、成人儿童双系统四大功能, 个人商务办公、娱乐观影、亲子陪伴、儿童学习娱乐为一体, 成为新时代领先的家庭娱乐终端。

**EdenPURE**

**宜盾普 (广东) 智能科技有限公司**

**N3-3C41**

**Yidunpu (Guangdong) Intelligent Technology Co., Ltd**

地址: 广东省佛山市顺德区大良街道绿田路顺德创客中心 B 栋一楼 (528300)  
电话 /Tel: 0757-22226648  
传真 /Fax: 0757-22226648  
网址 /Web: <http://www.edenpure.net.cn/>

宜盾普于 1962 年在美国正式成立, 注册商标 “EdenPURE”, 意为 “帮助全球用户打造舒适纯净的居家乐园”, 旗下拥有高端净水产品—EdenPEER。在追求舒适, 提升幸福的人类进化史中, EdenPURE 充分发扬发明者的角色, 深耕电热、净水等方向的研发专利。早在上世纪 80 年代, EdenPURE 明星产品蒸烤箱、取暖器、净水器等就已经风靡全球, 在室内环境改善和居家饮食健康层面, 帮助消费者达成生活理想。

**主要展品 /Products**

即热式净饮机、茶吧机、气泡水机、破壁机、微蒸烤、蒸烤箱、咖啡机、破壁机、空气炸锅、多功能锅、电陶炉等

**EIWEI 亦为**

**亦为超声技术 (深圳) 有限公司**

**E1-1B41**

**ultrasonic technology (Shenzhen) Co., Ltd**

地址: 深圳市宝安区西乡街道盐田社区银田工业区 37 栋 608 (518102)  
Address: 608, building 37, Yintian Industrial Zone, Yantian community, Xixiang street, Bao'an District, Shenzhen  
电话 /Tel: 13923737278  
网址 /Web: [www.eiwei.com.cn](http://www.eiwei.com.cn)

EIWEI 亦为是超声波技术研发、生产制造、销售服务为一体的高科技企业, 公司以技术先行, 不断探索超声波技术在家庭及行业的解决方案和产品应用。公司立足深圳广州无锡三地, 服务全球客户, 以技术先行驱动产品研发制造, 目前已形成超声波清洗换能器, 超声波焊接振子的技术研究开发生产



服务, 超声波家庭电器系列、实验室仪器系列、医用清洗消毒系列、工业精密清洗系列, 同时向国内外客户提供超声领域的解决方案及技术配套。

Eiwei is also a high-tech enterprise integrating ultrasonic technology application research and development, production, manufacturing and sales service. The company takes technology first, deeply develops and constantly explores the solutions and product applications of ultrasonic technology in families and industries. Based in Shenzhen, Guangzhou and Wuxi, the company serves global customers and drives product R & D and manufacturing with technology. At present, the company has formed technical research, development and production services for ultrasonic cleaning transducer and ultrasonic welding vibrator, ultrasonic household appliances series, laboratory instruments series, medical cleaning and disinfection series and industrial precision cleaning series, At the same time, we provide solutions and technical support in the field of ultrasound to customers at home and abroad.

#### 主要展品 /Products

超声波清洗机

Ultrasonic cleaning machine

## récolte®

易思得(北京)品牌管理有限公司  
E&W Co.,Ltd

E2-2C01

地址: 北京市朝阳区望京悠乐汇 E 座 1503 (100102)

Add: 1503, Tower E, ULO PARK, 601# Wangjingyuan, Chaoyang District, Beijing, China

电话 /Tel: 13725355512

传真 /Fax: 010-00000000

我司是日本 recolte(丽克特)品牌在中国的营销公司, 负责全系产品在华的品牌建设、产品推广、渠道开拓与维护、产品批发及零售等全链路业务。

recolte(丽克特), 日本知名料理家电品牌。始创于 2009 年, 十二年来本着对日式匠心的坚持和美学灵感的探索, 成为年轻人新式厨房的明星产品, 经常被推荐为礼物。法语中 recolte 意为“收获”, 希望可以治愈你的胃也温暖你的心, 为每一天生活带来新的收获!

As the marketing company of brand 「recolte」 in China, we responsible for full-link business ,including brand building, product promotion, channel development and sales.

“recolte,” meaning “harvest” in French , is a line of compact, colorful, simple and stylish consumer kitchen appliances. Our collection of personal-size items, feel “just right” for couples and small households. Pleasant to use and featuring high-quality design, our products suggest a new kind of lifestyle, and make great gifts as well. 「recolte」 since 2009. Encouraging your sense of creating a collection, recolte brings you a daily “harvest.”

#### 主要展品 /Products

厚夹三明治机、格子三明治机、迷你松饼机、多功能料理锅、迷你电饭煲、雨滴自动手冲咖啡机、咖啡机(迷你茶咖机)、空气炸锅、多功能食物料理机、电动开瓶器、真空记忆红酒瓶塞、多功能电火锅、电烤箱、迷你面包机、迷你豆浆机

Press Sand Maker Plaid, Press Sand Maker Quilt, Smile Baker Mini, Multi Functional Hotplate, Compact Rice Cooker, Rain Drip Coffee Maker, Solo Kaffe Plus, Air Oven, Capsule Cutter Bonne, ez Wine Opener, ez Wine keeper, POT DUO carré, Slide Rack Oven Delicat, Compact Bakery, Auto Cooking Pot

## IKIDG

易开得净水器  
IKIDE

N2-2E91

地址: 江苏省南通市崇川区通盛大道 188 号易开得大厦

电话 /Tel: 051385651088

易开得是集研发、生产、服务于一体的创新型净水品牌, 主要领域涉及家用生活用水及直饮水系统、商务饮水系统、超纯水技术生产等, 并自主研发净水控制系统与净水核心过滤元件。从研发、生产到营销, 易开得集合业内人才, 构建净水产业链闭环, 掌握科技核心, 专注于将净水科技推向新的高度。

#### 主要展品 /Products

中央净水机、中央软水机、反渗透净水机、全屋净水机、前置过滤器、净热一体机、管线机、商务直饮机

## KEMFLO 溢泰

溢泰(南京)环保科技有限公司  
Kemflo (Nanjing) Environmental Technology Co.,Ltd

N3-3C61

地址: 江苏省南京市江宁经济技术开发区爱涛路 19 号 (211106)

电话 /Tel: 86-025-52781358

网址 /Web: www.kemflo.net

溢泰公司 1978 年创立于台湾屏东, 集研发设计和生产制造于一体, 产品涵盖各类家用 / 商用净水系统及各式滤芯、滤瓶、压力桶和马达等零部件。为了保证产品质量及性能的优越, 我司花费巨资引进先进的生产设备和检验设备, 对所生产的产品在整体结构、安全性、功能性上做精准的检测, 务求让客户产品能够满足客户的高标准要求。

KEMFLO was established in 1978 in Pingtung, Taiwan. The company started with OEM business, producing plastic products for foreign well-known brands all over the world. As a highly integrated company, KEMFLO is excelled in research, design and manufacturing. With professional ability and continuous investment, KEMFLO provides our customers with high-quality products at the most competitive price and prompt service. Nowadays, KEMFLO products have been distributed and promoted into the global market.

To ensure the superior quality of KEMFLO products, we invest a lot in the most advanced production equipment and testing equipment for accurate tests on the product performance. KEMFLO is also applying the latest software, hardware and technology to develop new products, so as to allow KEMFLO to be in the forefront of the industry, and to meet the highest standards.

#### 主要展品 /Products

饮用水净化系统、全屋净化系统、商用净化系统、滤瓶组件、滤芯组件等  
Drinking Water Filtration System, POE Filtration System, Commercial Water Purification System, Housings, Cartridges.etc



## MINTEL

### 英敏特信息咨询(上海)有限公司

N3-3A45

#### Mintel Group Ltd

地址: 上海静安区武宁南路1号越商大厦23楼(200042)

电话 /Tel: 021-53205918

网址 /Web: <https://china.mintel.com/>

英敏特洞悉消费者需求, 解读深层原因。作为全球知名的市场研究咨询公司, 我们分析消费者、市场、产品创新和竞争格局, 提供对全球和地方经济的独特视角。自1972年成立以来, 我们的预测型分析和专业推荐已经帮助很多客户更迅速地制定更明智的商业决策。英敏特的愿景是助力客户业务增长, 为员工成长加码。敬请关注 [china.mintel.com](http://china.mintel.com) 或关注微信公众号了解更多。

Mintel is the expert in what consumers want and why. As the world's leading market intelligence agency, our analysis of consumers, markets, product innovation and competitive landscapes provides a unique perspective on global and local economies. Since 1972, our predictive analytics and expert recommendations have enabled our clients to make better business decisions faster. Our purpose is to help businesses and people grow.

#### 主要展品 /Products

英敏特中国报告——深入洞悉了解中国消费市场您的明智之选。全年更新涵盖16大品类的135篇报告, 融合独立消费者调研、可信市场数据与专家分析, 解读市场表现的深层原因, 精准判断市场的未来走势, 为企业和品牌的下一步行动提供切实可行的建议。

Mintel Reports China - The smartest way to understand global trends and what they mean to China. The 2023 Mintel China Report continues to plunge deeper into the market with 135 reports covering 16 categories, exploring consumer trends in more segmented categories. In the reports, we interpret market dynamics for brands, provide inspiration for product innovation, and tap into consumer demand.



### 永康市超锐电器有限公司

N3-3B28

#### YONGKANG SIPPON ELECTRIC CO., LTD

地址: 浙江省永康市西城街道四方路75号(321300)

Add: 75th Sifang Road, Xicheng Street, Yongkang City, Zhejiang Province

电话 /Tel: 18767885081

传真 /Fax: +86-579-87232350

网址 /Web: [www.sippon.com](http://www.sippon.com)

永康市超锐电器有限公司, 致力于吸尘器行业的发展, 以塑造和发扬民族品牌“SIPPON 思博”为己任, 我公司已获得 CE,GS,ROHS,CB,SAA,ETL, ISO9001 等国际认证。致力于吸尘器行业的发展, 倾全力打造一支最专业的吸尘器生产、销售、研发和技术团队。思博的产品目标是“研发和制造更美观、更耐用、更节能、更低噪、更高效的专业吸尘器”。

WE ONLY FOCUS ON VACUUM CLEANER

About sippon:

\* Started from March, 2013

\* Initial Investment: 2 million USD

\* keep developing 2-4 new models per year

\* National High-tech Enterprise

\* China Technology Enterprise

\* National patent demonstration enterprise

\* Aimed to produce the best vacuum cleaner

Our exports have grown from \$2 million to \$15 million, our workers have grown from 20 to 130, also our production equipment has increased from 4 to 18. Our company is developing better and better, stronger and stronger.

We have Wet and Dry/ Ash/ Dry/ Industrial/ Battery/ Steam also Handhold vacuum cleaners.

We purchase the motors from Cinderson, which is TOP3 in Chinese market.

Many Cooperative brands:

\* Hyundai \* Daewoo \* Lowe's \* TSC \* Casino \* Qlima \* Jula \* Sealey \* Bimar \* Sellnet \* Powerplus

#### 主要展品 /Products

手持 / 吸灰 / 干湿 / 干式 / 工业 / 蒸汽 / 智能垃圾桶

Handheld/ Ash/ Dry/ Wet& dry/ Industrial/ Steam/ Trash Can vacuum cleaners



### 永康市乐事智能科技有限公司

E2-2A35

地址: 浙江省金华市永康市城西新区月桂南路110号

电话 /Tel: 0579-87172323

永康市乐事智能科技有限公司, 是一家集设计、研发、生产、销售于一体的专业型生产供应服务商。具备智能机器人的研发、电机及控制器系统研发; 家用电器研发; 五金产品制造及销售。

#### 主要展品 /Products

智能自动清洗洗地机, 除菌双贴边洗脱一体。对厨房污渍、宠物毛发、地毯上的藏污纳垢, 都能有效的清除。



### 永林电子股份有限公司

W5-5C51

#### Y.LIN ELECTRONICS., LTD.

地址: 广东省东莞市樟木头镇金河工业区新光路6号(523620)

Add: No.6, Xinguang Road, Jinhe Industrial Zone, Zhangmutou Town, Dongguan City,

Guangdong Province

电话 /Tel: 076987181888

传真 /Fax: 076987181888

网址 /Web: [www.yong-lin.net](http://www.yong-lin.net)

永林电子股份有限公司成立于2005年, 是一家集研发、生产、销售为一体的高科技民营企业, 广东省高新技术企业; 主营 LED 发光二极管、数码管、红外线产品、UVC、大健康光电等 LED 产品, 可为客户提供优质的产品定制服务; 永林秉承“客户至上、以人为本、变革创新、合作共赢”的经营理念,

多年来专注 LED 产品制造, 目前永林的产品已衍生至“消费性电子、智能厨电、智能家居、网通、玩具、美容保健、医疗器械”等众多领域;

Y.LIN Electronics Co., LTD. founded in 2005, is a high-tech private enterprise integrating R&D, production and sales. It is a high-tech enterprise in Guangdong Province. Main LED LED LED, digital tube, infrared products, UVC, big health photoelectric and other LED products, can provide customers with quality product customization services; Yonglin adhering to the "customer first, people-oriented, innovation, win-win cooperation" business philosophy, over the years to focus on LED products manufacturing, yonglin products have been derived from "consumer electronics, intelligent kitchen appliances, smart home, netcom, toys, beauty and health care, medical equipment" and many other fields;

#### 主要展品 / Products

直插灯珠、SMD 灯珠、小贴片灯珠、数码管  
IR 系列 / PT 光敏三极管 / 光电开关 / IRM 系列 灯珠  
智能穿戴与心率监测灯、UVC 杀菌灯

LAMP LED, PLCC LED, CHIP LED, DISPLAY LED, INFRARED PRODUCT,  
SMART WEAR, UVC LED



#### 悠伴

**Ningbo Upany Intelligent Technology Co., Ltd**

地址: 浙江省宁波市慈溪市人和路 555 号天鸿大厦 11 楼

电话 / Tel: 15067431583

网址 / Web: www.upany.com

悠伴成立于 2019 年, 是宁波嘉乐智能科技股份有限公司旗下新消费厨电品牌。以“我的悠智厨房”为品牌定位, 通过高颜值厨电产品和智能化用户体验, 为追求健康生活、乐于分享的人物享受到“悠闲、乐趣、智能”的悠智厨房生活方式。悠伴从创立之初就组建自己的核心科研团队, 并已突破多项创新技术, 相继推出空气炸锅、空气烤箱、果蔬净化机、冰激凌机、多功能料理锅、低糖饭煲等创新小家电。

#### 主要展品 / Products

空气炸锅、果蔬净化器、多功能料理锅、低糖饭煲等创新小家电



**友贸电机(深圳)有限公司**

**Nichibo Motor(Shenzhen) Co., Ltd**

地址: 深圳市光明区马田街道薯田埔社区科杰二路 268 号 (518106)

Add: No. 268, Kejie 2nd Road, Shutianpu Community, Matian Street,  
Guangming District, Shenzhen

电话 / Tel: 0755-29697722

传真 / Fax: 0755-29697710

**N3-3F51**

**W1-1D86**

网址 / Web: www.nichibo-motor.cn

友贸电机创立于 1976 年, 位于深圳市光明新区, 总使用面积达到 60,000 m<sup>2</sup>, 每月产能 10,000,000 个; 专业研发及生产制造直流马达, 拥有一贯化的制程管理, 从转子芯片、马达外壳、塑胶盖、转子、盖子、定子到马达成品组合, 均自行制造, 品质全程监控。产品规格种类繁多, 应用在家电用品、汽车机件、电动玩具、电动工具等领域, 更可专为客户产品量身订作马达, 提供技术服务, 产品行销海内外深获世界知名厂商的肯定。

Nichibo-motor was established in 1976 and located in Guangming New District, Shenzhen. With a total area of 60,000 square meters, a maximum monthly production capacity is expected to reach of 10,000,000 units. It specializes in R&D and manufacturing of DC motors. It has a consistent process management, from rotor chips, motor housing, plastic cover, rotor, cover, stator to finished motor combination are all manufactured by ourselves, and the quality is monitored throughout the process. There are a wide range of product specifications, mainly used in household appliances, auto parts, personal belongings, electric toys, power tools and other fields. We can also customize motors for customers' products and provide technical services. The product was well sold by home and abroad and has won the affirmation of world well known manufactures.

#### 主要展品 / Products

扫地机器人马达、手持吸尘器马达、拖地机器人马达、咖啡机马达、电动窗帘马达、汽车马达、电动工具马达、医疗办公马达、通讯及机械马达

Electric tool motor, Automotive equipment motor, Smart home appliance motor, Medical apparatus motor, Communication & machinery motor



**余姚市富达电子有限公司**

**YUYAO CITY FUDA ELECTRONIC CO., LTD**

地址: 余姚市凤仪路 78 号 (315400)

Add: No.78 fengyi Road, Yuyao City, Zhejiang Province, P.R.China

电话 / Tel: 0574-62833527

传真 / Fax: 0574-62814752

网址 / Web: www.fudae.com

**N3-3F91**

余姚市富达电子有限公司成立于 1996 年。本公司是一家以生产电水壶、烤面包机、咖啡机、煮蛋机等小家电为主。公司建筑面积 100000 平方米, 员工 1300 余人, 年生产小家电 1000 万台, 是全球主要电热水壶制造商之一。

工厂通过了 ISO9001:2008、ISO14001: 2004 和 OHSAS18001:2007 质量管理体系认证。我们将竭诚为您提供优质的产品, 合理的价格, 准时的交货和最好的服务!

**DEWEI****余姚市德威电器电机有限公司****Yuyao Dewei Electric Appliance Co., Ltd****E3-3B35**

地址: 浙江省余姚市小曹娥镇工业园区 (315475)

Add: Industrial Zone ,Xiaocao'e,Yuyao,Zhejiang

电话 /Tel: 0574-62080359

传真 /Fax: 0574-62082399

网址 /Web: www.dewei-elec.com

德威电器电机有限公司成立于 2003 年, 是一家专业生产电吹风、直发器、卷发器等小家电产品的企业。目前产值近 1.5 亿人民币。

产品销售涵盖国内和出口到世界各地, 主要销往欧洲、美国、南美等 50 多个国家。

公司现有员工 380 余人, 生产线 7 条, 月生产能力 30 万件以上, 拥有从产品设计、CNC 模具加工、直流电机生产、注塑、发热丝加工、喷涂、装配组装等完整的生产加工流程。

我们拥有开展 OEM 和 ODM 的能力。

Yuyao Dewei Electrical Appliance Co., Ltd. is a specializing in the production of personal care appliances. The Company products are exported to all parts of the world. Dewei Company aspired to provide high-quality R&D, design and production services in the field of personal care products to global leading brands. After nearly 15 years of development, the Company has gradually formed an enterprise with the whole process of design, research and development, mold development, and manufacturing.

The Company's current production plant is nearly 35,000 m<sup>2</sup> with 380 employees; The Company's assembly workshop has 7 assembly lines, which can provide a capacity of 300,000pcs to 350,000pcs per month.

The Company has more than 60 kinds of hair care products, such as, hair dryer, hair straightener, hair curler, etc. which are exported to more than 50 countries and regions in Europe, North America and South America.

In 2021, estimate the sales amounted increased to nearly RMB150 million yuan.

**主要展品 /Products**

电吹风, 直发器, 卷发器, 拉发器等个人护理类电器产品

hair care appliance products ,hair dryer, hair straightener, hair curling irons,hot air styler,etc

**余姚市佳永士电器有限公司****E3-3A36**

地址: 绍兴市上虞区永和镇三桥村永安南路 1 号

Add: No.1,Yong'an South Road , Shixiqiao , Sanqiao Village , Yonghe Town , Shangyu District ,

Shaoxing City , Zhejiang Province(Beside YongFeng Highway)

电话 /Tel: 13566572157

网址 /Web: http://www.jys-electric.com

余姚市佳永士电器有限公司(老公司), 绍兴市邦硕电器有限公司(新公司) 位于余姚西附近, 交通便利, 经济发达的绍兴地区。本公司创建于 2009 年是一家专业生产小家电系列的厂家, 月生产量 20 万台, 生产的产品有热风梳, 吹风机, 卷发器, 果蔬面膜机, 直发器和负离子梳等。主要产品已取得“GS”,“CE”,“CB”证书, 产品销往世界各地, 深受客户的青睐和好评。

YUYAO JOYS ELECTRICAL APPLIANCE CO.,LTD(old factory) , SHAOXING BANGSHUO ELECTRICAL APPLIANCE CO.,LTD(new factory) near the east of yuyao, located in 2009, is a professional production of small appliance manufactures with years of experience, the monthly output 20 hundred thousand sets , the product are hot air brush , hair dryer , hair curler , fruit and vegetable mask machine , hair straightener , ionic hair brush etc . Main products already have the "GS","CE","CB"certificate , the products are sold to all over the world , and they had the favored customers and praise.

**主要展品 /Products**

热风梳, 吹风机, 卷发器, 果蔬面膜机, 直发器和负离子梳。

hot air brush , hair dryer , hair curler , fruit and vegetable mask machine , hair straightener , ionic hair brush .

**余姚市斯博瑞净水设备有限公司****N1-1B47****YUYAO SPRING WATER FILTER EQUIPMENT COMPANY**

地址: 中国浙江省宁波市余姚市三七市镇旷世工业园 (315413)

Add: Kuangshi industrial park, san qishi town,yuyao city,ningbo ,zhejiang province ,china

电话 /Tel: 15900543839

网址 /Web: www.yyspring.net

余姚市斯博瑞净水设备有限公司, 坐落于全国著名的塑料王国——余姚, 占地面积 6000 平方米, 是一家以微型泵、电磁阀产品及相关技术为核心, 集产品设计、研发、制造、营销为一体的高新技术企业。

公司通过 ISO9001 质量体系认证, 拥有数十项泵阀技术专利, 产品通过 CQC/ROHS/CE/ 卫生涉水批件等认证, 产品远销美国, 欧洲, 非洲, 韩国, 东南亚等国内外几十个国家和地区。

YUYAO SPRING WATER FILTER EQUIPMENT CO.,LTD, located in Yuyao city--the famous plastic product kingdom of China, covers an area of 6000 m<sup>2</sup>, our main product is Micro pump and solenoid valve .we are high tech enterprises with product design, development,manufacturing,and sales together.

With ISO9001 quality control system certificate, more than 10 patents of pump and valve, our products has passed the test of CQC/ROHS/CE and approval document of drinking water .Our products were exported to dozens of countries and regions include :American/Europe/Africa/korea/Southeast Asiannand so on.

**主要展品 /Products**

我们的主要产品是微型泵、电磁阀, 滤芯。主要以产品及相关技术为核心, 集产品设计、研发、制造、营销为一体的高新技术企业。公司通过 ISO9001 质量体系认证, 拥有数十项泵阀技术专利, 产品通过 CQC/ROHS/CE/ 卫生涉水批件等认证

Our main product is Micro pump and solenoid valve and filter cartridge .We are high tech enterprises with product design, development,manufacturing,and sales together. With ISO9001 quality control system certificate, more than 10 patents of pump and valve, our products has passed the test of CQC/ROHS/CE.



## 爱仕达 挂烫机

余姚市天猫电器有限公司

W4-4A52

地址: 浙江省宁波余姚郑巷村

电话 /Tel: 13454749189

公司专业生产 15 年立式挂烫机和手持式挂烫机 ~

主要展品 /Products

公司专业生产 15 年立式挂烫机和手持式挂烫机 ~



余姚市中建电器有限公司

E1-1B46

Yuyao Zhongjian Electrical Appliance Co., Ltd

地址: 余姚市泗门镇 329 国道复线 29 号 (315472)

Add: Simen Town, Yuyao City, Zhejiang Province, China

电话 /Tel: 13615885388

传真 /Fax: 86-0574-62162279

网址 /Web: www.zhongjiandianqi.com

余姚市中建电器有限公司创建于 2006 年,坐落于浙江省余姚市,公司专业生产电源线、插头、插座、电线组件、漏电保护插头等。公司占地面积 3 万平方米,建筑面积 2 万平方米,现有固定资产 3000 万元,员工 360 余人,中高级专业技术人员 30 余人。公司已获取 CCC、VDE、UL、KTL、SAA、BSI、PSE、IMQ、UC 等世界各国认证。竭诚欢迎海内外新老客户前来公司考察、洽谈业务、期待与您携手共创辉煌!

Established in 2006, Yuyao Zhongjian Electrical Appliance Co., Ltd. It is located in Zhejiang province, which is within the core economic area of Yangtze River delta. Our company is specializing in manufacturing cable, plugs, sockets, power cords, power bars and extension cords. There are over 260 staffs and more than 30 professional technicians. There are 30 million RMB fixed assets in our company, covering an area of 30 thousand square meters with the construction area of 20 thousand square meters. Our products have already passed the CCC VDE UL SAA BSI UC KTL PSE and so on; With Establishing a fine environment for mutual progress idea, and To win market with high quality, and customers trust as our guiding quality policy, we make progress day by day. We are looking forward to establishing long term cooperation with you. Welcome you friends to come and strive for win-win goal together with us.

主要展品 /Products

电源线、插头、漏电保护插头

## OECHSLER

Driving Ideas into polymer-based solutions – creatively, rapidly, globally.

裕克施乐塑料制品 (太仓) 有限公司

W2-2B13

地址: 江苏省太仓市广州东路 9 号 (215400)

电话 /Tel: 051253593687

传真 /Fax: 051253593615

网址 /Web: www.oechsler.com

公司于 1864 年由 Matthias Oechsler 成立, 经过 150 多年的历练, 已发展成为具有国际领先地位的塑料技术供应商。在欧洲、亚洲和美洲公司驻地。大约 3,100 名工作者积极投入的员工的帮助下, 我们制造出让生活更便捷、更安全以及更舒适的产品。对产品开发的独特敏锐度, 我们的销售额已保持多年增长, 并在 2018 年达到约 4.3 亿欧元。将开辟新的业务领域, 通过创新进一步拓展现有的领域延续公司的辉煌历史。

Founded in 1864 by Matthias Oechsler, the company has developed into a leading international supplier of plastic technology after more than 150 years of experience. Through corporate locations in Europe, Asia and the Americas, we are close to our customers. With the help of approximately 3,100 engaged employees, we make products that make life easier, safer and more comfortable.

Thanks to our strengths and our unique acumen for product development, our sales have been growing for many years and reached about 430 million euros in 2018. We will open up new business areas, further expand existing areas through innovation, and continue the glorious history of the company.

主要展品 /Products

推杆执行器、旋转执行器;

push actuator; rotation actuator;

## MicRadar

云帆瑞达科技 (深圳) 有限公司

W4-4B43

Micradar Technology (Shenzhen) Co., LTD

地址: 广东省深圳市福田区天安数码城创新科技广场二期西座 501A (518000)

Add: 501A, West Block, Phase II, Innovation Technology Plaza, Tian 'an Digital City, Futian District, Shenzhen city, Guangdong Province

电话 /Tel: 0755-88602663

传真 /Fax: 0755-88602663

网址 /Web: www.micradar.cn

云帆瑞达科技 (深圳) 有限公司是成都宋元科技的全资子公司, 在雷达核心算法、天线、微电子产品领域具有核心专利并占据市场领先地位。公司具备独立完整的射频研发、验证, 生产, 测试体系。公司提供 24G、60G、77G、79G、多频段人体传感器。包含精准人体存在, 人体跌倒报警, 睡眠呼吸监护, 睡眠质量监护, 人体呼吸心跳, 轨迹分析, 人数统计, 姿势判断等多种智能家居, 居家养老, 家电赋能的产品。

Micradar Technology (Shenzhen) Co., LTD . is a wholly-owned subsidiary of Chengdu Songyuan Technology. It has core patents in the fields of radar core algorithms, antennas, and microelectronics and occupies a leading market position. The company has an independent and complete RF R&D, verification, production and testing system. The company provides 24G, 60G,

77G, 79G, multi-band human sensors. Including accurate human presence, human fall alarm, sleep breathing monitoring, sleep quality monitoring, human breathing and heartbeat, trajectory analysis, people counting, posture judgment, and many other smart home, home care, home appliances empowered products.

#### 主要展品 /Products

人体毫米波雷达, 精准人体存在, 人体跌倒报警, 睡眠呼吸监护, 睡眠质量监护, 人体呼吸心跳, 轨迹分析, 人数统计, 姿势判断等多种智能家居, 居家养老, 家电赋能的产品。

Human body millimeter wave radar, accurate human presence, human fall alarm, sleep breathing monitoring, sleep quality monitoring, human breathing and heartbeat, trajectory analysis, people statistics, posture judgment and other smart homes, home care products, home appliances empowered products.

ZEL

#### 扎努西电气机械天津压缩机有限公司

W2-2H81

#### Zanussi Elettromeccanica Tianjin Compressor Co., Ltd

地址: 天津港保税区(空港) 保税路3号(300308)

Add: 3 Baoshui Road, Tianjin Port Free Trade Zone (AirPort Industrial Park)

电话 /Tel: 8.6228486169e+011

传真 /Fax: 02284861687

网址 /Web: www.zeltj.com

扎努西电气机械天津压缩机有限公司, 1992年07月09日成立, 经营范围包括开发、研究、设计、生产及销售全封闭压缩机、家用电机及其零部件; 精密机械加工; 金属结构、模具制造; 机械设备制造、维修、技术开发、技术服务; 机械设备、电器设备、仪器仪表、钢材、五金交电的销售; 自营和代理货物及技术进出口(依法须经批准的项目, 经相关部门批准后方可开展经营活动)

Zanussi Elettromeccanica Tianjin Compressor Co., Ltd, established on July 09, 1992, its business scope includes development, research, design, production and sales of fully enclosed compressors, household motors and their parts; precision machining; Metal Structure, mold manufacturing; Mechanical Equipment Manufacturing, maintenance, technology development, technical services; mechanical equipment, electrical equipment, instrumentation, steel, hardware Jiadian sales; Self-employed and acting as agent for the import and export of goods and technologies (projects subject to approval according to law may be operated only after approval by relevant departments)

#### 主要展品 /Products

ZEL 专业从事全封闭活塞式压缩机产品的研发和制造, 产品可广泛应用于冰箱、冷柜及各种小型商用制冷设备。ZEL 的产品范围广、种类齐全, 覆盖了从 R134a 到 R600a, 从低背压 (LBP) 到中高背压 (HMBP)、从定频到变频的范围, 并能满足全球不同区域电压的需求。产品种类包括了自意大利引进的 Tau 和独立研发的 Lambda、Zeta、Micro、VSC 共五大平台 200 多个型号规格。

ZEL develops and manufactures refrigerating hermetic compressors. Five platforms include Tau licensed from Italy and independent development of compact, high efficiency Lambda, Zeta, Micro and VSC series. With more than 200 models are covering LBP and HMBP applications for household refrigerators, chest freezers and small size commercial applications. Wide variety of voltage ranges is available with constant and variable speed design for R600a and R134A refrigerant.

EÜPA

#### 漳州灿坤实业有限公司

E2-2F71

#### TSANN KUEN (ZHANG ZHOU) ENTERPRISE CO., LTD

地址: 福建省漳州市台商投资区灿坤工业园 (363000)

Add: Tsann Kuen Industrial Park, Taiwanese Investment Zone, Zhang Zhou, Fujian, China

电话 /Tel: 0596-6268899

传真 /Fax: 0596-6268064

网址 /Web: https://www.eupa.cn

灿坤集团成立于 1978 年, 是知名的小家电专业制造商, 其产品行销 80 多个国家和地区。集团拥有 600 多名工程师, 拥有中国、日本、美国和欧洲跨国研发设计团队, 产品多次获得国际著名设计奖项, 长期与多家电品牌建立策略合作, 为其设计并提供商品。中国市场部成立于 1993 年, 拥有包括咖啡文化、美食调理、居家帮手、食物处理等商品, 致力于以香醇的咖啡、美味的甜点、鲜纯的果汁及舒适的家居, 为大众提供精致的生活体验。

The leading household appliance manufacturer, since 1978

Main operation focus: dual core business : 1. Factory of world 2. Electronic channel

No one offers more than we do. Total solution provider, from product development to high quality production. We are the factory of world .

Life style oriented design.

Multi national well-organized management

Full product lines in household appliances

Professional manufacturer in industry

Strong commitment to continuous R&D

#### 主要展品 /Products

咖啡机 搅拌机 牛排机 华夫饼机 无烟烧烤盘 帕尼尼机 电饼铛 空气炸锅 多士炉 煮蛋器 食品烘干机  
Coffee maker . Blender. Steak grill. Waffle Maker. Smokeless grill. Panini maker. Pizza maker. Air fryer. Toaster. Egg cooker. Food dehydrator

AUPO

#### 漳州雅宝电子股份有限公司

N3-3A15 3A16

#### Zhangzhou AUPO Electronics Co., Ltd.

地址: 福建省漳州台商投资区角美镇鸿渐路 6 号 (363107)

Add: No.6, Hongjian Road, Jiaomei Town, Taiwan business investment zone, Zhangzhou

电话 /Tel: 0596-6268552

传真 /Fax: 0596-6268551

网址 /Web: www.aupo.com

历经多年的匠心守护、开拓创新, 雅宝电子已跻身于全球热熔断体制造商前列。

AUPO 品牌创始至今, 已累计生产超过百亿支热熔断体, 广泛应用于冰箱、空调、洗衣机、厨房小家电、美健等家电及其他领域, 为上万家客户提供可靠、安全、稳定的过热保护方案, 并成为全球众多知名家电品牌的指定供应商, 在行业内树立了“专业、专注、高效、有诺必达”的典范。

After years of innovation & efforts, AUPO has made its way to the top manufacturer of thermal cutoffs in the world.



Since its inception, AUPO has produced more than 10 billion thermal cutoffs, which are widely used in refrigerator, air conditioner, washing machine, kitchen appliance, health & beauty and other applications, providing reliable, safe and stable overheating protection solutions for thousands of customers, and we have become the designated supplier of many well-known household appliances brands in the world. We have set up an example of professional, efficient and promise-fulfilling in the industry.

#### 主要展品 /Products

温度保险丝、温控器、高分子热敏电阻  
TCO, Thermostat, PPTC



#### 长沙安致美科技有限公司 Changsha Anmei Technology Co., Ltd.

E3-3A26

地址: 长沙经济技术开发区星沙街道办事处三一工业城魔豆仓一楼 (410100)  
Add: SANY Industrial Park, Economic and Technological Development Zone,  
Changsha, Hunan, China  
电话 /Tel: 13510687869  
传真 /Fax: 13510687869  
网址 /Web: www.anmeiusa.com

Anmei 致力于成为典雅设计与高品质的健康护理电器品牌。

Anmei manufacture is uniquely focused on building our OEM customer's brands through innovation, investment in quality, and an uncompromising commitment to continuous improvement. We would love the opportunity to discuss your manufacturing project in depth to provide you with competitive pricing. Our clients products are often brought to market faster by partnering with Anmei manufacture to produce the most efficient manufacturing processes, experts in the various industries we serve.

#### 主要展品 /Products

设计美学与卓越性能的完美融合

便携式一体化设计, 具有极好的便携性, 2小时极速快充, 超静音操作;

IPX7 设计和全球电压。非常适合出差旅行。

洁齿护龈黑科技 - 智能脉冲水流技术, 轻松排出食物残渣和细菌;

同时能够按摩牙龈, 促进牙龈的血液循环, 呵护口腔健康。

适合白领人群: 有效清除口腔问题带来的烦恼, 清新口气,

8岁以上儿童及正畸种植牙人士。

Anmei Waterflosser A30



#### 爱星物联 U-BASES CLOUD

#### 长沙博安通软件科技有限公司

W3-3A30

#### Changsha B&T Software Technology Co., Ltd.

地址: 长沙市雨花区万家丽中路三段36号喜盈门商业广场1、2栋及地下室21001房 (410000)  
Add: Building 1, 2 and Room 21001 in the Basement, Xiyiyingmen Commercial Plaza, No. 36,  
Section 3, Wanjieli Middle Road, Yuhua District, Changsha.  
电话 /Tel: 18922811075  
网址 /Web: http://www.iot-aithings.com/

爱星物联 IoT 云平台系统的核心价值是帮助环境电器与家居品牌商设备智能化, 将 IaaS、PaaS、SaaS 的能力全部打通, 构建一个完整的闭环生态。全链路从最底层的智能硬件开发到上层提供 OEM App 开发、云开发平台和行业解决方案。通过私有云部署, 企业对于一切信息拥有完整的控制权, 设备产生的海量数据与企业的业务数据融合后产生巨大的价值, 能够促进企业高效低成本运营, 进而提升整个社会生产效率。

The core value of U-Bases Cloud platform system is to help environmental appliances and home appliance brand owners to intelligently their equipments, to open up all the capabilities of IaaS, PaaS, and SaaS, and to build a complete closed ecosystem. The whole service includes OEM App development, cloud development platform and industry solutions from the lowest level of intelligent hardware development to the upper level.

Through private cloud deployment, enterprises have complete control over all information, and the massive data generated by the equipment and the business data of the enterprise can be combined to generate huge value, which can promote the efficient and low-cost operation of the enterprise, thereby improving the production efficiency of the whole society.

#### 主要展品 /Products

专注 IoT 私有云平台部署

1. 小家电行业全品类轻松支持
2. 设备低代码开发, 无需开发人员即可上手
3. App 零开发, 通过配置生成自有品牌 App
4. IoT 私有云部署, 商业数据专享
5. 支持千万级设备接入和大量用户使用
6. 平台可开源、易维护、易定制



#### 长沙多浦乐泵业科技有限公司

W5-5A13 5A14

#### TOPS Industry and Technology CO., Ltd

地址: 长沙市雨花区振华路519号国际创新城15栋  
Add: Building 15th, No.519 International Innovation Park, Zhenhua Road, Yuhua District,  
Changsha City, Hunan Province, China  
电话 /Tel: 0731-82739266  
传真 /Fax: 0731-82739255

长沙多浦乐泵业科技有限公司是专业直流无刷水泵和直流隔膜泵生产厂家, 国家高新技术企业, 主

要出口欧美高端市场。自建厂房 1.6 万平方米, 拥有自主贴片厂及注塑厂,ESD 防静电管控数字车间, 全自动电子线、电机线、水泵组装线, 年产能 500 余万台。是行业内唯一通过德国莱茵 TÜV IATF16949& ISO9001 双质量体系认证的企业, 产品主要应用: 家用电器、水暖床垫、智能马桶、汽车行业、医疗设备 and 冷却领域等。

TOPSFLO is a professional DC brushless water pumps and DC diaphragm pumps manufacturer, main export to the high-end markets in Europe and America, also the national high-tech enterprise. It has a self-built factory 16,000 m<sup>2</sup>, own SMT and plastic injection factory, ESD anti-static control digital workshop, automatic electronic production lines, motor production lines and pump assembly lines, with annual production capacity of more than 5 million pieces. TOPSFLO has been certified by the German Rhine TUV ISO 9001 and IATF16949 and has a CNAS standard national laboratory. The pumps are mainly used in water heaters, home drinking appliances, water heating mattresses, car preheaters, water cooling systems, printers and medical equipment etc.

#### 主要展品 /Products

厨下热饮机泵、热水器泵、净水器泵、水暖床垫泵、智能马桶增压泵、加湿器泵、智能家用电器泵、汽车泵、太阳能泵、医疗设备用泵

Brushless DC Water Pump, Water Heater Pump, Small Household Drinking Appliances Pump, Water Heating Mattress Pump, Smart toilet booster pump, Medical Equipment Pump, Car Circulation Water Pump, Solar DC Circulation Pump



#### 肇庆晨辉电子科技有限公司

W5-5C71

地址: 肇庆市高要区要南 1 路 (526100)

Add: Yaonan 1st Rd., Gaoyao District, Zhaoqing, Guangdong

电话 /Tel: 0758-5968088-2000

传真 /Fax: 0758-5968088-2008

网址 /Web: www.ch-fan.com

肇庆晨辉电子科技有限公司是一家集研发、制造、销售散热风扇为一体的国家高新技术企业。公司现有国家专利 50 余项, 于 2017 年通过 "IATF16949 质量体系" 认证; 2018 荣获 "广东省创新型企业" 称号; 被授予 "广东省博士工作站"; 2020 年获得 "广东省微特轴流散热风机工程技术中心" 认定。行业内首家实现全自动化生产线生产的企业, 年产能 5000 多万台。产品先后通过 TUV、UL、CE、RoHS 等认证。

Zhaoqing Sheng Hui Electronic Technology Co., Ltd was founded in 2006, after 13 years of development, Sheng Hui has developed into a modern manufacturer with 10,000 square meters and 400 employees.

Our main products are DC fan. AC fan. EC fan, axial fan and centrifugal fan which are widely used in telecommunication, power units, inverter, medical devices. LED lights, home appliances, automotive electronic products, air purifiers, action intelligent devices, and so on.

Until 2019, we had setted up 8 automatic production lines and 4 manual production lines. Annual output reach 30 million pieces.

we are "PHILIPS" global designated cooling fan supplier as well as designated partners with TCL, Changhong, Changcheng and Midea.

#### 主要展品 /Products

轴流风扇、离心风扇、鼓风机

Axial fan, centrifugal fan, blower

## AIBOTE

艾波特 净水设备智造领跑者

### 浙江艾波特环保科技股份有限公司

E2-2F51

#### Zhejiang Aibote Environmental Technologies INC.

地址: 浙江省慈溪市高新技术产业园区新兴大道 988 号

Add: NO.988, Xinxing Road, High-tech Industrial Development Zone, Cixi, Ningbo, Zhejiang Province, China

电话 /Tel: 0574-63073571

网址 /Web: www.aibote.com.cn

浙江艾波特环保科技股份有限公司成立于 2005 年, 18 年专注净水产品研发智造、销售和服务, 以极具竞争力产品和服务, 为客户和用户创造价值。

公司掌握净水核心技术, 生产智造能力行业领先, 占地面积 50000 平米, 标准化无尘自动化厂房 46670 平米, 研发大楼 3900 平米, 年产能净水产品 500 万台。

公司自主运营 "水丽" 和 "攸品" 两个品牌市场, 并与国内外包括世界 500 强知名品牌和企业, 建立多形式价值合作关系。

Founded in 2005, with 18 years devotion in research, intelligent manufacturing and sales of water treatment equipment, Zhejiang Aibote Environmental Technologies Inc. has created substantial values for customers and users all over the world by its extremely competitive products and services.

Aibote has mastered the core water filtration technology and equipped with leading intelligent manufacturing capacity. With a floor area of 50000 square meter, 46670 square meter of standard dust-free automation workshop and 3900 square meters of R&D building, Aibote's annual production capacity can reach 5 million units.

Aibote independently operate "Cilly" and "UPONES" two own brands, and have developed multi-form valuable cooperation with many world Top 500 brands and enterprise at home and abroad.

#### 主要展品 /Products

公司以优秀产品为客户创造价值, 为用户创造愉悦体验, 产品有厨下集成净水机、台上免安装净饮机、嵌入式净水机、智能茶吧、智能母婴净饮机、智能管线机、智能龙头等 7 大产品系列, 产品性能与功能卓越, 全面提升优质健康饮用水需求。

公司掌握净水行业核心技术, 包括集成水路、集成滤芯、纯水置换、纯废水动态调控、静音设计等行业领先技术应用, 产品具有出水水质好、体积小、安全性高、噪音低、寿命长、使用和换芯便捷等优点。

Our Company with excellent products to create value for customers, for users to create pleasant experience. Products are 7 series: undersink water filtration, countertop Instant hot RO system, builtin water purification, smart tea-bar, mother and child drinking machine, Pipeline water purification, Intelligent faucet. Product performance and function excellence, it raised demand for quality and healthy drinking water. Our company master the core technology of water purification industry, including Integrated water and filter, pure water displacement, and silent design. Our product has the advantages of good water quality, small size, high safety, low noise, long life, convenient use and filter change.



**AIKE 艾克****浙江艾克电器有限公司  
Zhejiang Aike Appliances Co., Ltd.****N3-3C96**

地址: 浙江省台州市仙居县福应街道永安工业园区春晖东路 12 号 (317306)  
Add: 12 Chunhui Road (E), Yongan Industrial Zone, Xianju County, Taizhou, Zhejiang  
电话 /Tel: 0571-88890379  
传真 /Fax: 0571-86686865  
网址 /Web: <https://www.aike.cn>

AIKE 艾克电器创立于 1992 年, 30 多年来始终专注于洗手科技产品的研发和制造, 致力于龙头式干手器、高速干手器、免接触皂液器、免接触手消毒器等商用及家用洗手科技产品的普及化应用, 拥有众多国际权威认证, 产品远销欧盟、美国、澳大利亚、日本、巴西、以色列、台湾等 130 多个国家和地区, 与众多国际知名品牌保持长期战略合作关系。

Founded in 1992, AIKE Electric Appliances has been focusing on the R&D and manufacturing of hand-washing technology products for more than 30 years. The popularized application of hand-washing technology products such as hand sanitizers has many international authoritative certifications. The products are exported to more than 130 countries and regions such as the European Union, the United States, Australia, Japan, Brazil, Israel, Taiwan, etc., and have maintained a long-term relationship with many internationally renowned brands Strategic partnership.

**主要展品 /Products**

龙头式干手器、高速干手器、自动感应皂液器、自动感应手消毒器、厨房气龙头  
Air Tap, High speed hand dryer, Automatic soap dispenser, Automatic hand sterilizer, Kitchen Air Tap

**AIERKA 爱尔卡®****浙江爱尔卡智家科技有限公司****N2-2A29**

地址: <https://www.aierka.com/>  
电话 /Tel: 4006658007  
网址 /Web: <https://www.aierka.com/>

浙江爱尔卡厨卫科技有限公司, 坐落于浙江省海宁市袁花阳光科技小镇。公司成立至今十多年, 现已发展为集成水槽、集成灶、手工水槽、烤箱等厨房电器设计、研发、制作、销售于一体的现代化厨电企业, 是集成水槽发明企业, 国家标准制定单位。2022 年, 爱尔卡投资 1.2 亿元在浙江海宁新建集成净洗中心一期新厂房, 投产后将成为中国专业的集成水槽、集成净洗中心生产基地, 产能将达到每年 8 万台, 可以满足 10 亿元的市场需求。

**主要展品 /Products**

集成水槽、集成灶、洗碗机、手工水槽、不锈钢橱柜、燃气热水器、电蒸箱、电烤箱、净水器、垃圾处理

**浙江爱瑞卡普田电器有限公司  
Zhejiang elica putian electric Co., Ltd****N4-4C61**

地址: 浙江省嵊州市普田大道 88 号 (312400)  
Add: No. 88 Putian Avenue, Shengzhou 312400  
电话 /Tel: 0575-83366001  
传真 /Fax: 0575-83366000  
网址 /Web: [www.elica.cn](http://www.elica.cn)

elica- 来自意大利的高端厨电专家。1970 年创立至今已有 50 年历史, 是生产吸油烟机和电磁灶的全球领先企业之一, 是制造家用通风电机的欧洲领导者之一。致力于在家庭通风、空气过滤和净化领域, 向用户和专业人士提供超乎寻常的价值。elica 在意大利、波兰、墨西哥、印度和中国拥有 7 个制造工厂。受到意大利设计原则的启发, 结合最创新的技术开发产品。设计, 空气处理和烹饪融合在一起, 是不断研究创新解决方案的结果。

Elica - a high-end kitchen electricity expert from Italy.

Founded in 1970, it has a history of 50 years. It is one of the world's leading enterprises in the production of cooking hoods and Induction. It is also one of the European leaders in the manufacture of household ventilation motors. It is committed to providing extraordinary value to users and professionals in the fields of home ventilation, air filtration and purification. Elica has 7 manufacturing plants and more than 3800 employees in Italy, Poland, Mexico, India and China. Inspired by Italian design principles from the beginning, we develop products with the most innovative technology. The integration of design, air handling and cooking is the result of continuous research and innovative solutions.

**主要展品 /Products**

公司主要生产吸油烟机, 电磁灶, 燃气灶, 微波炉, 蒸箱, 烤箱, 嵌入式冰箱, 吸尘器, 垃圾处理器, 净水器, 酒柜

The company mainly produces cooking hood, Induction, gas hob, microwave oven, steam box, oven, embedded refrigerator, vacuum cleaner, garbage processor, water purifier, wine cabinet

**AOTIN 奥田**

让每一餐都健康快乐

**浙江奥田电器股份有限公司****N1-1C51**

地址: 浙江嵊州市江一路 8 号  
电话 /Tel: 0575-83370969  
网址 /Web: [www.aotin.net](http://www.aotin.net)

奥田集团 1987 年创始于浙江嵊州, 三十余年耕耘和发展, 奥田已成为高端智能创新集成厨电领军品牌之一。拥有浙江、河南两大制造基地共 50 万平方米配备先进流水线设备、数控设备以及智能激光切割机等先进工业设备, 专注智能创新集成厨电及家居定制产品等 9 大产品品类, 业务覆盖集成厨电、传统厨电、精品生活电器、橱柜等品质家居产品, 布局整体厨房, 为客户提供高品质整体智能厨房解决方案。

**主要展品 /Products**

集成厨电、传统厨电、精品生活电器、橱柜等品质家居产品

**浙江百润轴承有限公司**  
**ZheJiang Baron Bearing Co., Ltd****W2-2B26**

地址：浙江省嘉兴市平湖市曹桥街道兴曹路 333 号 (314000)

Add: No.333, Xingcao Road, Caoqiao Street, Pinghu, Jiaxing, Zhejiang

电话 /Tel: 0571-88092651

传真 /Fax: 0571-88095191

网址 /Web: www.brbearing.cn

百润轴承是一家集研发、设计、制造于一体的精密薄壁轴承、不锈钢薄壁轴承、微型法兰轴承专业制造商；产品广泛应用于电子科技产品、机器人、金融设备、医疗器械、健身器材等。拥有先进的全自动轴承生产线，以及高素质的技术开发团队和精干熟练的员工，精心打造了 BARON 这个品牌轴承，为满足不同用户专业量身定制轴承服务方案。

百润轴承本着“诚信、双赢”的发展理念，愿与国内外客商精诚合作，携手前进，共创美好未来。

Baron is a professional manufacturer which is specializes in the researches,developments,manufactures and sells of precision thin-wall bearing, stainless steel thin-wall bearing, miniature flange bearing, which are widely used in electronic products, financial equipment, medical equipment, fitness equipment, etc. Together with high-qualified technical development team and skilled staffs, Baron built BARON Bearing to customize professional bearing for different customers.

"Integrity, win-win" is the development concept of Baron, we are sincerely willing to cooperate with domestic and foreign customers, hand in hand for a better future.

**主要展品 /Products**

精密薄壁轴承 67 系列

精密薄壁轴承 68 系列

精密薄壁轴承 69 系列

MF/MR 微型轴承系列

不锈钢薄壁轴承系列

**浙江百悦康科技股份有限公司**  
**Zhejiang Beyok Technology Co., Ltd.****N2-2A30**

地址：浙江省嘉兴市南湖区七星镇三店路 398 号 (314000)

Add: No. 398 Sandian Road, Qixing Town, Nanhu District, Jiaxing City, Zhejiang Province

电话 /Tel: 0573-82888388

传真 /Fax: 0573-82888488

网址 /Web: www.beyok.com

浙江百悦康科技有限公司 22 年专注于臭氧发生器、空气净化及水处理系统、健康电器等环保健康领域。一直以先进臭氧技术为导向，是行业颇具实力的科技型企业。获得专利 100 多项，承担过多项省市级科技项目，荣获“浙江省专利示范单位”、“浙江省科技型企业”、“雏鹰企业计划”、“企业技术研发中心”等荣誉。

Zhejiang Baiyuekang Technology Co., Ltd. has been focusing on ozone generators, air purification and water treatment systems, health appliances and other environmental protection and health fields for 22 years. Has been guided by advanced ozone technology, is the industry's quite powerful science and technology enterprises. It has obtained more than 100 patents, undertaken a number of provincial and municipal science and technology projects, and won the honors of "Zhejiang Patent Demonstration Unit", "Zhejiang Science and Technology Enterprise", "Young Eagle Enterprise Plan", "Enterprise Technology Research and Development Center" and so on.

**主要展品 /Products**

一体化臭氧发生器、一体化臭氧发生模块、一体化空消臭氧模块、分体管式臭氧模块、片式空消臭氧模块、克级臭氧发生模块、小型空气消毒机、管道空气消毒机、小型臭氧水机组、中型臭氧发生器、大型臭氧发生器、微型气泵、负离子发生器、紫外线杀菌器、气源处理产品、气水混合产品、胶管气石接头。

Integrated ozone generator, integrated ozone generation module, integrated air elimination ozone module, split tubular ozone module, sheet air ozone elimination module, gram grade ozone generation module, small air disinfection machine, pipeline air disin

**浙江佰航电器有限公司**  
**ZHEJIANG BAIHANG ELECTRICAL APPLIANCE CO., LTD****W1-1A13**

地址：浙江省宁波市鄞州区姜山镇狮桥路 255 号 (315100)

Add: No.255 Shiqiao Road, Jiangshan Town, Yinzhou Dist., Ningbo City

电话 /Tel: 0574-88073636

传真 /Fax: 0574-88073737

网址 /Web: www.cn-baihe.com

浙江佰航电器有限公司

原宁波百禾电器燃具有限公司

品牌：百禾

百禾创建于 2001 年，公司原位于浙江省宁波市鄞州区姜山镇翻石渡工业区，2018 年注册浙江佰航电器有限公司，并于 2021 年正式启用，搬迁至浙江省宁波市鄞州区姜山镇狮桥路 255 号，厂房用地面积 20 亩，总建筑面积 3 万平方米。企业专业生产专业生产燃气灶、洗碗机、电磁炉等厨房电器产品及户外烧烤、野营系列产品。

**主要展品 /Products**

燃气灶、洗碗机、电磁炉等厨房电器产品及户外烧烤、野营系列产品



### 浙江拜尔智能科技有限公司

E3-3C21

地址: 浙江省宁波市鄞州区创苑路 98 号智慧园 1 期 1 号楼 601  
电话 /Tel: 18668131222

拜尔品牌诠释: “拜”即崇拜、敬畏, “尔”即您, 指用户。拜尔以创造美好生活为己任, 为用户提供具有时尚美学和实用的高品质、人性化的智能生活家电产品和服务。

拜尔品牌旗下产品涵盖: 口腔护理、个人护理、生活电器、厨房电器四大品类

拜尔品牌秉承三好宗旨: “好产品、好服务、好体验”, 以工匠精神开展精工制造, 在品质上精益求精。

拜尔人以“崇实、精进、乐观、卓越”作为企业的核心价值观!

#### 主要展品 /Products

口腔护理: 电动牙刷、冲牙器

个人护理: 剃须刀、高速吹风机

生活电器: 扫地机、洗地机

厨房电器: 料理机、磨粉机



### 浙江畅洁电子科技有限公司

N4-4B45 4B46

Zhejiang Changjie Electronic Technology Co., Ltd

地址: 浙江省丽水市缙云县壶山镇丽缙产业园苍岭路 1 号

Add: No.1 Cangling Road, Lijin Industrial Park, Huzhen Town, Jinyun County,  
Lishui City, Zhejiang P.R, China

电话 /Tel: 400-009-6926

浙江畅洁电子科技有限公司成立于 2020 年, 占地 20000 平米。公司专业生产智能洗地机、布艺清洗机 etc 家用清洁设备, 是一家集研发、生产、销售于一体的制造商。

公司现有员工 300 人, 有完善的 6S 管理系统。研发人员有 5 人从事吸尘器行业 10 年以上, 产品拥有外观结构专利以及 CCC, CE, FCC, ROHS 等测试报告和认证, 现产品畅销德国、英国、美国、俄罗斯、印尼等国家和市场。竭诚期待您的合作!

Zhejiang Changjie Electronic Technology Co., Ltd. was established in 2020 and is located in Jinyun City, Zhejiang Province, covering an area of 20,000 square meters. The company specializes in the production of household cleaning equipment such as intelligent floor washing machines and cloth cleaning machines. It is a manufacturer integrating R&D, production, and sales.

#### 主要展品 /Products

洗地机、布艺清洗机、宠物清洗用品

Upright Vacuum Cleaner/Cloth Washing Machine/Pets Cleaning Machine etc.

## RAYI® 锐亿

浙江超人科技股份有限公司

E3-3E31

ZHEJIANG SUPERHUMAN TECHNOLOGY CO., LTD

地址: 浙江省永康市经济开发区北湖路 116 号 (321300)

电话 /Tel: 0579-87232488

传真 /Fax: 87232488

网址 /Web: www.supman.com

浙江超人科技股份有限公司自成立以来, 一直专注于剃须刀及个人护理电器研发、制造及销售。现已成为一家以“自主研发”、“精工制造”和“品牌运营”为三大核心竞争力的高科技制造企业。拥有强大技术开发实力, 吸收国际前沿高科技技术, 招揽行业顶尖人才, 以市场为导向, 以满足顾客的需求为己任, 锐意创新、匠心工艺、理性经营。

#### 主要展品 /Products

剃须刀、电吹风、电动牙刷、毛球修剪器、理发器



浙江朝晖过滤技术股份有限公司

E2-2A23 2A24

Zhejiang Zhaohui Filter Technology Co., Ltd.

地址: 浙江省嘉兴市桐乡市世纪大道 370 号

Add: No.370, Century Avenue Development Zone Chongfu Town, Tongxiang Zhejiang, China

电话 /Tel: 021-62586212

传真 /Fax: 0573-88222622

网址 /Web: www.zftcn.com

朝晖股份, 成立于 1990 年, 是一家“以材料为基础, 气、液两翼齐飞”的大型环保科技型企业, 专注于过滤、分离、净化材料与产品的研发、制造和工程应用。公司是国内首家研发、生产地面清洁过滤系统的企业, 产品已远销欧美、亚太等 50 多个国家和地区, 目前已成为家电空气净化产品的全球最大供应商。

朝晖业务领域已经涵盖空气净化材料、吸尘器过滤配件、空气净化器净化系统、家用净水器净水系统、工业水处理系统等过滤行业核心产品。

Founded in 1990, Zhaohui Filter Technologies is a material-based scientific corporation engaged in environmental protection through air and liquid purification. The company dedicates itself to R&D, manufacture and engineering application of filtration, separation and purification materials and products. As the pioneer in filtration system R&D and manufacture for floor care industry, Zhaohui has now become the world's largest supplier for air purification accessories with products exported to more than 50 countries and regions in Europe, America, Asia and the Pacific. Zhaohui's business covers air purification materials, vacuum cleaner filtration parts, air-purifying system, domestic water conditioning and industrial water treatment. Committed to these core fields of filter industry, Zhaohui is a leading comprehensive enterprise in both air and water filtration.

#### 主要展品 /Products

空气滤网、初效滤网、高效滤网、宠物滤网、新风滤网、净水滤芯、水滤芯、净水器滤芯、RO 滤芯、超滤滤芯、复合滤芯

air filter, pre filter, High efficiency filter, ptfе filter, UF filter, water filter

COOKER  
KING**浙江炊大王炊具有限公司**  
**zhejiang cooker king cook co., ltd****N3-3G96**

地址: 浙江省永康市经济开发区九鼎路 599 号 (321300)

Add: No.599 Jiuding Road Yongkang City, Zhejiang Province, China

电话 /Tel: 18621812167

传真 /Fax: 057987232289

网址 /Web: www.cookerking.cn

浙江炊大王炊具有限公司, 有 39 年炊具的研发制造销售经验, 产品远销 68 个国家及地区, 公司拥有 Sedex, SA8000, ISO 工厂体系认证。

Since then we have grown to be one of the top 3 cookware brands in China, with over 300 cookware products and manufacturing cookware for well-known brands and retailers in over 50 countries worldwide. Cooker King adheres to the principle of "strive to achieve perfection and realize win-win situation". With our spirit of "Quality first" we have built the trust of diverse range of business partners at home and abroad.

To ensure product quality meets the needs of our customer requirements, we bring in advanced management concept and advanced production equipment. We are in accordance with ISO9001:2000 quality system to control the production processes, such as design, raw materials, processing, assembling, testing and after-sales service. With over 80,000 square meters of production area, 1000 employees, including 60 managers and technicians, we form a diverse range of personnel at our Cooker King family creating a great and friendly team.

**主要展品 /Products**

铝制不粘锅, 拉伸, 仿压, 压铸工艺。铁炊具  
aluminum Non-stick cookware, Carbon steel cookware

**浙江达峰科技有限公司**  
**Zhejiang Dafeng Technology Co., LTD****W4-4B08**

地址: 浙江省杭州市余杭区五常大道 158 号 (310023)

Add: No.158, Wuchang Avenue, Hangzhou, Zhejiang, China

电话 /Tel: 86-0571-89080780

传真 /Fax: 86-0571-89080779

网址 /Web: www.dafeng.com.cn

浙江达峰科技有限公司是国内领先的智能控制器制造服务提供商。公司成立于 1997 年, 注册资本 2200 万, 年销售额 6 个亿。是国内最早从事各种微控制器研发、生产、销售、服务的高新技术企业。目前, 公司业务涉及白色家电、厨房用具、医疗卫生、热水器产品, 汽车电子等。公司拥有拥有卓越的研发能力和严谨的品质管控体系, 在行业内率先通过了 ISO9001、ISO14000、TS16949、及 3C 认证。

Zhejiang Dafeng Technology Co., LTD is one of the leading EMS (electrical manufacturer service) provider. It was founded in 1997, with registered capital 3.5 million USD and the annual turnover

reaches 100 million USD. It has become one of the national high-tech enterprises which early engaged in R&D, production, sales and service of various micro-controllers(PCBAs) Currently, our company business involves with the White goods, Kitchen appliances, Medical and health, Water heater products etc. We have inverter control technology, HMI technology, APP, Cloud platform whole solution. As one of the pioneers that have passed ISO9001, ISO14000, TS16949 and 3C certification, our company business involves with the White goods, Kitchen appliances, Medical and health, Water heater products etc. We have inverter control technology, HMI tec.

**主要展品 /Products**

业务范围覆盖各种智能控制器、无线通讯、物联网产品以及周边相关的移动端 APP、智能服务云平台; The business covers various intelligent controllers, wireless communication, Internet of things products, mobile terminal apps and intelligent service cloud platforms related to the surrounding areas

**浙江达威电子股份有限公司**  
**Zhejiang Dawei Electronic Co., Ltd.****N1-1B06**

地址: 浙江省温州市乐清市城东街道城东产业功能区永和二路 12 号 (325600)

Add: No. 12 Yonghe Second Road, Chengdong Industrial Function Zone, Chengdong Street, Yueqing City.

电话 /Tel: 0577-57578051

传真 /Fax: 0577-62110371

网址 /Web: www.daweiele.com

浙江达威电子是一家专业从事器具开关、耦合器、温控器、电磁阀、水泵的控制器供应商。产品广泛应用在智慧厨房、健康家居、智能卫浴等领域。我们以优质的服务, 卓越的品质, 创新的产品先后成为美的、九阳、苏泊尔、海尔、云米、GE、Tefal、Panasonic、Electrolux、Nanja 等中外知名品牌的合格供应商。我们致力于提供专业的控制器解决方案, 为客户创造最大价值, 成为全球专业的控制器供应商。

Zhejiang Dawei Electronics Co., Ltd. is a professional supplier of appliance switches, couplers, temperature controllers, solenoid valves, water pumps, products are widely used in smart kitchen, healthy home, intelligent sanitary ware and other fields. We by the high quality service, excellent quality, innovative products has become a beautiful, sun, supor, haier, cloud, GE Appliance, Tefal, Panasonic, Electrolux, Symphony, Nanja such as Chinese and foreign well-known brands of qualified suppliers. We are committed to providing professional controller solutions to create maximum value for customers and become a professional controller supplier in the world.

**主要展品 /Products**

器具开关、耦合器、温控器、电磁阀、水泵  
Switch/AC connector/Thermostat/Valve/Pump



**daan 大安电子****浙江大安电子科技有限公司****Zhejiang Daan Electronic Technology Co., Ltd.**

地址: 浙江省嘉兴市海宁市长安镇凤翔路 28 号 (314423)

电话 /Tel: 0573-87979307

传真 /Fax: 0573-87979300

网址 /Web: www.zjdaan.com

**W2-2A15**

公司是一家专业为家电等行业提供 IMD/IML 面板、ITO 柔性线路 / PDOT 银浆线路及薄膜开关等表面装饰专业配套服务的民营科技企业。建有丝网印刷中心、注塑制造中心、ITO 柔性线路制造中心和模具制造中心, 形成以模内复合产品为主, 其他产品辅助的综合配套格局。凭借领先的技术和现代化的生产设备及科学的管理, 并长期致力于新技术、新工艺的研发和探索, 向客户提供设计, 开发、制造一条龙服务。

**主要展品 /Products**

IMD/IML 面板、ITO 柔性线路 / PDOT 银浆线路及薄膜开关

**浙江东亿磁业有限公司**  
**Zhejiang Dongyi Magnetic Co., Ltd.**

地址: 浙江省丽水市壶镇镇苍岭路 18 号 (321404)

Add: No.18 Cangling Road, Huzhen Town, Jinyun County, Lishui City, Zhejiang Province, China

电话 /Tel: 0578-3279753

传真 /Fax: 0578-3262661

网址 /Web: www.zjdycy.com

**E1-1B30**

浙江东亿磁业有限公司专业生产吸尘器, 公司成立于 2004 年, 主要产品有干湿两用吸尘器, 吸灰桶。

Zhejiang Dongyi Magnetic Co., Ltd. is one of the largest manufacturer of vacuum cleaner, established in 2004, we professionally produce wet and dry vacuum cleaner and ash vacuum cleaner.

**主要展品 /Products**

吸尘器

vacuum cleaner

**多迪斯泰****浙江多迪斯泰保健器材有限公司****Zhejiang Dotast Healthcare Equipment Co., Ltd**

地址: 浙江省丽水市青田县赤岩工业区浙江多迪斯泰保健器材有限公司 (323903)

Add: No.30, ChiYan Industrial Zone, chuanliao Town, Qingtian County, Lishui City, Zhejiang Province

**W5-5D51**

电话 /Tel: 4009919119

网址 /Web: www.dotast.cn

浙江多迪斯泰保健器材有限公司位于著名的“中国生态第一市”浙江省丽水市。公司拥有 400 余名员工。具备年生产组装按摩椅 3 万多套的能力。同时, 公司拥有素质优良、技术精湛的员工团队以及现代化的厂房和先进的生产设备。企业通过 ISO9001、2000 国际体系认证、应用 ERP 资源管理系统, 产品通过 CB、CE 及 ROHS 环保认证。

Dotast is a Chinese massage chair manufacturer established in 2008. Since then, it has become an important player in the massage chair industry. In Dotast, we believe that it is the products which makes a company great, and this drives us keep working hard in the researching & developing of massage technics.

Start from a small workshop, we are now operating two factories in Lishui city, Zhejiang China, and with more than 400 employees, meanwhile, the annual production capacity has reached 30,000 pcs.

The company is running strictly under the ISO 9001: 2000 certification system, and all our products have been approved by the CE, CB and RoHS certification. It guaranteed our quality by following all these certifications, and makes us competitive in the market. In 2015, Dotast was selected as the top 10 massage chair brand in the Chinese market. And it has been certificated by the state government as a high tech company.

**主要展品 /Products**

按摩椅

MASSAGE CHAIR

**浙江蜂鸟新材料有限公司**

地址: 中国浙江省嘉善县大云镇卡帕路 166 号 中德生态产业园 B 区 9 幢

电话 /Tel: 13636595345

**W2-2B04**

浙江蜂鸟新材料有限公司成立于 2021 年, 通过近 20 年的市场跟踪和产品研发, 与压缩机核心客户的密切合作, 2021 年公司开始向市场提供马氏体阀片材料的解决方案, 尤其首先实现了不锈钢阀片材料的国产化。公司依托自身的技术研发、市场渠道与资源获取优势, 充分整合国内外、上下游供应链, 通过配套关键的技术研发、生产设备和质量管控体系, 具备了设计、研发、生产、销售和服务于一体的能力

Zhejiang Hummingbird Novel Materials is established in 2021 and located in Sino-German Eco-Industrial Park, District B, Dayun Town, Jiashan County, Jiaxing City, Zhejiang Province. The series valve strip solutions have been offered from 2021 by Zhejiang Hummingbird Novel Materials Co., Ltd with marketing researching and diving into RD on flapper valve strip over two decades and cooperating closely with key clients and suppliers, especially achieving domestication of stainless-steel strip for flapper valve, and satisfying various demanding applications and fulfilling more fast and stable delivery.

**主要展品 /Products**

HM 47M 是浙江蜂鸟推出的全流程国产化的压缩机阀片不锈钢带材料, 填补了国内在该领域的空白, 并列入了工信部《重点新材料首批次应用示范指导目录 (2021 年版)》

该产品针对进口阀门片材料进行了重新研发设计:

1. 成分优化, 添加合金元素细化晶粒、提高组织均匀性、耐腐蚀性和耐磨性。
2. 真空处理, 材料的纯净度显著提升, 夹杂物含量极低。
3. 先进的热处理工艺, 获得的组织更加细小均匀, 显著提高抗疲劳性能。

As a hardening and tempering stainless-steel strip for compressor valve applications with full domestic supply chain, HM 47M has been launched by Zhejiang Hummingbird Novel Materials Co., Ltd and bridged the gap in this area in China, and included in the "Catalogue of Demonstration and Guidance for the First Batch Application of Key New Materials (2021 Edition)" issued by the Ministry of Industry and Information Technology.

To fulfil the increasingly demanding requirements, the valve strip has been designed as below:

1. Fine grain technology, some alloy elements have played a beneficial role on the finer grain, uniformity of metallographic structure, corrosion resistance and wear resistance.
2. Vacuum treatment for improving the purity of the raw materials significantly and decreasing the inclusion content with a very low level.
3. The cutting-edge heating treatment for the final finer and more uniform microstructure with higher fatigue performance.



### 浙江弗里斯检测技术有限公司

#### Zhejiang Fries Testing Technology Co., Ltd.

W3-3A23

地址: 浙江省慈溪市白沙路街道三北大街 2588 号 C7 五楼 (315300)

Add: Fifth floor, C7, No. 2588, Sanbei street, Baisha road street, Cixi City, Zhejiang Province

电话 /Tel: 0574-63120004

传真 /Fax: 0574-63120004

网址 /Web: www.china-fsda.com

FSDA 是一家专注于促进人类健康提升而打造的健康环境相关产品一站式服务商, 专业提供检测、评价及技术服务的综合性第三方机构, 为您的企业提供一站式解决方案。

FSDA 具有一批拥有丰富科研及检测经验的工作人员, 公司严格按照 ISO/IEC 17025-2017 及 RB/T214-2017 管理体系运营, 并符合相关运行要求。先后建立了涉水产品、消毒杀菌产品、材料、家用电器、环境卫生 5 个专业实验室。

FSDA is a one-stop service provider of health and environment related products focused on promoting human health. It is a comprehensive third-party organization specialized in providing testing, evaluation and technical services to provide your enterprise with one-stop solutions. FSDA has a group of workers with rich scientific research and testing experience. The company operates in strict accordance with ISO / IEC 17025-2017 and Rb / t214-2017 management systems and meets relevant operation requirements. It has successively established five professional laboratories for aquatic products, disinfection and sterilization products, materials, household appliances and environmental sanitation.

#### 主要展品 /Products

1. 涉水产品检测、2. 消毒净化产品检测、3. 家电检测、4. RoHS 检测、5. 食品接触材料检测

1. Detection of aquatic products
2. Inspection of disinfection and purification products
3. Household appliance inspection
4. ROHS test
5. Detection of food contact materials

Gorbo®

浙江冠宝电子

### 浙江冠宝电子有限公司

#### ZHEJIANG GUANBAO ELECTRONIC CO., LTD.

N3-3A48

地址: 中国浙江省乐清市南塘镇装备制造园 (325618)

Add: Equipment Manufacturing Park, Nantang Town, Yueqing City, Zhejiang Province China

电话 /Tel: 0577-62251281

传真 /Fax: 0577-62251861

网址 /Web: www.gorbo.cn ; www.guanbao.com

冠宝电子有限公司创办于 1988 年, 位于“天下奇秀”的国家“5A”级名胜风景区温州雁荡山——乐清市南塘工业区。公司专业研发、设计、制造“Gorbo”为品牌的器具开关、插座、电子定时开关等系列产品, 并先后通过了 CQC、CCC、CB、CE、ENEC、KC、TUV、UL、C-UL、ROHS、REACH、PAHS 等多个国家和地区的安规认证和环保认证, 同时公司建立了功能齐全完善 UL 认可的产品安规实验室。

Guanbao Electronics Co., Ltd. was founded in 1988. It is located in the national "5A" scenic spot of Wenzhou, the famous scenic spot of Wenzhou Yandang Mountain, the Nantang Industrial Zone of Yueqing City. The company specializes in R&D, design and manufacture of "Gorbo" branded appliance switches, sockets, Electronic timer switch and other products. The company's products have passed the safety certification and environmental protection certification of CQC, CCC, CB, CE, ENEC, KC, TUV, UL, C-UL, ROHS, REACH, PAHS and other countries and regions. Improve UL approved product safety laboratory.

#### 主要展品 /Products

跷板开关、旋转开关、微动开关、滑动开关、按钮开关、电子定时开关、AC 插座系列和电磁泵等。  
Rocker Switch、Micro Switch、Rotary Switch、Slide Switch、Push-button Switch、AC Socket、Electronic Timer switch、Electromagnetic pump。

Hochi

浙江合治

### 浙江合治科技有限公司

E2-2A42

地址: 浙江省杭州市余杭区仁和街道临港路 10 号联东 U 谷三期 5 幢 5 楼 (300000)

电话 /Tel: 4001818005

传真 /Fax: 0571-56009605

网址 /Web: www.zjhochi.com

浙江合治科技有限公司专注于环境净化性能实验室检测系统, 筹建规划, 设计方案, 设备施工, 以及整体全方面搭建。我们一直专注于各种过滤材料, 颗粒物 / 气相过滤器, 净化器 / 新风机 / 消毒机检测实验设备的生产与研发。凭借核心研发能力及自动化的独特优势, 积累了大量的技术成果和工程应用经验。积极参与各项国家标准, 服务于科研院校, 科研机构, 检测机构、家电企业等各行业领域, 深受广大用户好评。

#### 主要展品 /Products

主要产品: 过滤材料, 颗粒物 / 气相过滤器, 净化器 / 新风机 / 消毒机检测实验设备的生产与研发, 核心产品主要由空气 / 新风净化 / 消毒性能测试舱、颗粒物 / 气相过滤器测试设备, 过滤材料测试设备, 颗粒物 / 气态的污染物发生器、风洞实验台, 风量测试台, 模拟环境气候舱及各种非标检测设备和检测自动化系统

**NOVUS 诺为****浙江恒田科技有限公司****E3-3H86**

地址：中国·温州市瓯海区三溪工业区新棣路8号(325000)

电话 /Tel: 13600641380

传真 /Fax: 057786261277

公司成立于2003年，是一家专业从事卷/直发器设计、生产、销售于一体的企业。公司注册资本3500万元，拥有占地面积50亩、总投资2亿人民币的自有工厂。产品远销美国、德国、英国、西班牙、意大利、澳大利亚、日本等全球30多个国家和地区，秉持“诚信守恒、锲而不舍”的精神，倡导“以人为本、诚信经营、科技创新、品质服务”的发展思路，恒田努力争创“机制一流、人才一流、装备一流、信誉一流”的现代化企业。

**主要展品 /Products**

卷发棒、夹板、直发梳、蛋卷棒

**HXH<sup>®</sup>****浙江红星电业有限公司****W3-3A40****ZHEJIANG HONGXING ELECTRICAL CO., LTD**

地址：浙江省乐清市宁康东路1113号(325600)

Add: No.1113, Ningkang East Road, Yueqing City, Zhejiang Province, China

电话 /Tel: 0577-62117771

传真 /Fax: 0577-62317697

网址 /Web: www.hxdy.cn

浙江红星电业有限公司创建于1989年，是国家高新技术企业、中国电连接元件行业协会会员单位。公司主要生产家用电器、灯具、计算机、摩托车、电动车、汽车等配套的电连接器及端子，共计3000多个品种。公司已通过了ISO9001:2015版国际质量管理、ISO14001:2015环境管理及IATF16949:2016汽车质量管理体系认证，其低频连接器主导产品通过了UL, CE, TUV, CQC等

Zhejiang Hongxing Electric Co., Ltd. was founded in 1989, is the state high-tech enterprises, China Electric Plug Components Industry Association member units. The company mainly produces household appliances, lamps, computers, motorcycles, electric vehicles, cars and other supporting electrical connectors and terminals, a total of more than 3000 varieties. The company has passed ISO9001:2015 edition of International Quality Management, ISO14001:2015 environmental management and IATF 16949:2016 automobile quality management system certification, its low frequency connector leading products passed UL, CE, Tuv, CQC and so on

**主要展品 /Products**

连接器, 塑壳, 端子, 绝缘护套

CONNECTORS, HOUSING, TERMINAL, PVC SLEEVE

**java chem**  
佳华精化**浙江佳华精化股份有限公司****W4-4A23****Zhejiang Java Specialty Chemical Co., Ltd**

地址：浙江省宁波市小越镇边盖公路冯山段(312367)

Add: Fengkeshan Village, Xiaoyue Town, Shangyu District, Shaoxing City, Zhejiang, 312367, China

电话 /Tel: 0575-82536700

传真 /Fax: +86-575-82536705

网址 /Web: https://www.javachem.com

浙江佳华精化股份有限公司成立于2000年，是一家集有机硅塑料添加剂、高性能抗静电剂、聚丙烯特殊改性剂及特殊功能母料的研究、开发、生产、销售、服务为一体的科技型企业，为塑料行业提供持续化的解决方案。作为中国本土领先的塑料改性新材料制造商，凭借在塑料功能添加剂行业的丰富研发及应用经验，旨在成为高分子改性材料领域内备受推崇的行业标杆。

Zhejiang Java Specialty Chemicals Co., Ltd is a scientific and technological enterprise in research, development, production, sales and service of silicone additives, high-performance antistatic agent, special surface modifier and functional masterbatches. As a leading domestic plastic additive manufacturer, with rich experience in development and application of plastic additives, we aim to become highly respected industry benchmark in the area of modified polymer materials.

**主要展品 /Products**

PPSi@ 超级弹性体

PPSi@super elastomer

**浙江佳龙电子有限公司****W5-5A42****Zhejiang Jialong Electron Co., Ltd**

地址：浙江省温州市永嘉县千石工业区

电话 /Tel: 0577-85222566

网址 /Web: www.calonsw.com

本公司专业研发、设计、生产各类汽车开关、拨动开关、微动开关、按钮开关、轻触开关、振动开关、DC、AC插座、精密电子五金件等系列产品1000多种。拥有全自动化的机械设备和先进的工艺技术及完善的质量管理体系，年生产量达5亿多只各类开关。

我们通过了严格的ISO9001国际质量体系认证、RoHS有毒物质测试、CQC认证、TüV、UL、VDE、CCC、CE等认证。

**主要展品 /Products**

汽车开关、拨动开关、微动开关、按钮开关、轻触开关、振动开关、DC、AC插座、精密电子五金件



### 浙江金华富朗德工贸有限公司

#### Fulangde

地址: 浙江省金华市金东区岭下朱工业区釜阳街 508 号 (321000)

电话 /Tel: 18042221818

传真 /Fax: 0579-89117609

专业生产空气炸锅企业

#### 主要展品 /Products

空气炸锅

N3-3A19



### 浙江聚倍科技集团股份有限公司

#### Zhejiang Jubei Technology Group Co., Ltd.

地址: 浙江省湖州市德清县阜溪街道双山路 136 号 (314200)

Add: No. 136, Shuangshan Road, Fuxi Street, Deqing County, Huzhou City, Zhejiang Province

电话 /Tel: 4001616787

传真 /Fax: 057387772606

网址 /Web: www.bskwater.com

聚倍集团是全球领先的全场景净水系统一站式产品服务商, 聚焦行业前沿技术开发、材料研究、智能化研究、工业设计、终端设备研发, 打造全产业链生产智造平台和供应链生态系统, 以全域创新的研发实力、全产业链智造能力、强大的供应链系统和雄厚的软硬件实力, 赋能旗下倍世、倍瑞、倍煌、金橙等企事业中心及十余家子公司, 合力为全球一线品牌提供产品价值服务。

Jubei Group is the world's leading one-stop product service provider for all-scenario water purification systems, focusing on industry cutting-edge technology development, material research, intelligent research, industrial design, terminal equipment research and development, and building a full-industry chain production intelligent manufacturing platform and supply chain Ecosystem, with global innovative research and development capabilities, full-industry chain intelligence manufacturing capabilities, a strong supply chain system, and strong software and hardware capabilities, empowering its subsidiaries such as Beishi, Beirui, Beihuang, Jincheng and more than a dozen homes. The company works together to provide product value services for global top-tier brands.

#### 主要展品 /Products

前置过滤器、阻垢产品、地暖前置过滤器、漏水保护器、漏水前置过滤器、花洒、沐浴宝、RO 机、净水机、龙头过滤器、净水器模组

Pre-filters, anti-scaling products, floor heating pre-filters, water leakage protectors, water leakage pre-filters, showers, bathing treasures, RO machines, water purifiers, faucet filters, water purifier modules

W3-3F100



### 浙江凯成云母材料有限公司

#### Zhejiang Kaichen Mica Material CO., Ltd.

地址: 浙江省绍兴市越城区孙端工业园区创兴路 88 号

电话 /Tel: 13735368894

网址 /Web: www.kcmica.com

公司位于浙江绍兴, 地处中国东南沿海地区、浙江省中北部、杭州湾南岸, 公司创建于 1985 年, 是一家集研发、生产、销售为一体的云母绝缘材料企业, 主要生产云母带、无卤带、云母异型加工制品、云母法兰、新能源汽车云母制品等。我们可以基于客户的要求, 从原材料端进行个性化产品设计和提供技术服务方案, 产品用于高标准的电气绝缘耐温材料, 广泛用于 电线电缆、家用电器、冶金、化工、汽车、机车、船舶、航天航空等行业。

Zhejiang Kaicheng Mica Material Co., Ltd. is located in Shaoxing, Zhejiang Province, in the southeast coastal area of China, the north central part of Zhejiang Province and the South Bank of Hangzhou Bay. Founded in 1985, it is a R&D, production, sales as one of the mica insulation material manufacturing enterprises, mainly producing mica tape, halogen-free tape, special shaped mica products, mica heating film, mica products of new energy vehicles. Based on the needs of customers, we can carry out personalized product design and provide technical service solutions from the raw material end. Our products are used for high standard electrical insulation and temperature resistant materials, and are widely used in wire and cable, household appliances, metallurgy, chemical industry, automobile, locomotive, ship, aerospace and other industries.

#### 主要展品 /Products

生产各种型号的软硬云母异型冲制件、各种型号云母发热膜、云母管、各种型号温控器等, 产品广泛应用于冶金, 新能源汽车和各种家用电器

Various types of soft and hard mica special-shaped punching parts, all kinds of mica heating film, mica tube, temperature controller and so on. Those products are widely used in metallurgy, new energy vehicles and various household appliances.

E2-2B35

## KASJ 凯诗捷

### 浙江凯诗捷智能科技有限公司

#### Zhejiang KASJ Intelligent Technology Co., Ltd.

地址: 浙江省杭州市余杭区仓前街道宝晋未来商业中心 1 幢 1301 室

电话 /Tel: 18605745090

KASJ 凯诗捷总部坐落风景秀丽, 人杰地灵的浙江省杭州市余杭区未来科技城, 负责公司全渠道的销售运营, 工厂制造位于慈溪家电之都附海, 工厂占地面积 30 亩, 人员 430 人左右, 自动化工厂设施, 多种检测等设备。

#### 主要展品 /Products

足浴器、足疗机、制冰机

E3-3F31





KANGERLE

**浙江康尔乐电子有限公司****W3-3B20**

地址: 浙江省乐清市石帆镇朴湖工业区 (325608)

电话 /Tel: 0577-62314132

传真 /Fax: 0577-62320160

网址 /Web: www.chinakel.com

浙江康尔乐电子有限公司创建于1993年,是一家专业生产微动开关、防水微动开关、检测开关、轻触开关、船型开关、汽车按钮开关等系列的厂家。产品广泛应用于影像、电脑、汽车、安防、通讯等各种电气设备中。工厂于2016年顺利通过ISO9001:2015质量管理体系换版认证,2021年顺利通过IATF16949:2016体系认证,同时产品已获得UL、TUV、CB、CE、CQC、ROHS等产品认证。

ZHEJIANG KANGERLE ELECTRONICS CO.,LTD founded in Wenzhou city in 1993, is a leading manufacturer of micro switches, detector switches and push button switches. Our factory has passed ISO9001:2015 and IATF16949:2016 Quality Management System. Meanwhile, our switches have obtained the certification of UL,TUV,CE,CB,CQC,RoHS.

**主要展品 /Products**

微动开关、防水微动开关、检测开关、轻触开关、船型开关、汽车按钮开关

micro switch, waterproof micro switch, detector switch, tact switch, rocker switch, car switch

**浙江康米科技有限公司****E3-3B45****ZHEJIANG KANGMI TECHNOLOGY CO., LTD**

地址: 浙江省温州市平阳县海西镇屿屿路 F09

电话 /Tel: 18105775739

浙江康米科技有限公司是美容美发工具专业生产加工的私营有限责任公司,公司总部设在浙江省平阳县海西镇。公司拥有完整、科学的质量管理体系。诚信、实力和产品质量获得业界的认可。欢迎各界朋友莅临浙江康米科技有限公司参观、指导和业务洽谈。

**主要展品 /Products**

热风梳,直发器,理发剪等



Return Home

**浙江乐太厨具有限公司****N3-3A01****ZHEJIANG LATIM KITCHENWARE CO.,LTD**

地址: 浙江省永康市江南街道金星村翁埠自然村 666 号第 1 幢第 1 层、第 2 层 (321300)

电话 /Tel: 0579-89702208

传真 /Fax: 0579-87388282

浙江乐太厨具有限公司是西班牙 Fagor 品牌在中国地区的厨具、电炊具、多功能锅等产品的独家经销商,专注于不锈钢珐琅餐具、智能蒸烤箱、多功能空气炸锅等高端厨具的研发、生产、销售。年

营业额超 1500 万美元。公司非常重视研发,在压力锅产品上获得了 2 项国家发明专利及 20 余项实用新型 / 外观专利,不锈钢珐琅微压锅获得 2020 年度德国红点设计大奖。于 2020 年被认定为“国家高新技术企业”。

Zhejiang Latim Kitchenware Co., Ltd is the exclusive distributor of cookware, electric cookers, multi-functional steamer and other products of Spanish Fagor brand in China. We focus on the R&D, producing and sales of stainless steel enamel kitchenware, smart steaming oven, multi-functional air fryer and other high-level kitchen appliance.

Latim kitchenware has the automatic production line customized by Kawasaki, and was identified as a "national high-tech enterprise" in 2020.

The company attaches great importance to research and development, and has obtained 2 national invention patents and more than 20 utility model/appearance patents for pressure cooker products. The stainless steel enamel micro-pressure cooker has won the German Red Dot Design Award in 2020.

**主要展品 /Products**

电炊具、电加热多功能锅、智能烤箱、珐琅炊具、不锈钢珐琅压力锅

Electric cooker, Electric multi-functional cooker, Smart oven, Enamel cookware, Stainless steel enamel pressure cooker

**浙江璐瑶电子科技有限公司****E1-1A32****Zhejiang Luyao Electronics Technology Co., Ltd**

地址: 浙江省温州市平阳县万全镇纬一路

Add: Wei 1st Road, Mechanical Park, Wanquan Light Industrial Base, Wenzhou, Zhejiang, China

电话 /Tel: 0577-63776082

浙江璐瑶电子科技有限公司始于2001年,集研发,制造,营销为一体的按摩器品牌供应商和服务商。主营按摩棒、筋膜枪、按摩披肩,按摩枕,足浴盆,足疗机等保健健身器材系列,年产量超300万套。公司已通过BSCI,ISO9001,产品通过CE,ROHS,FCC,KC,ETL等质量认证。公司拥有一支高素质的营销和售后团队。产品远销欧美,东南亚,日韩等100多个国家和地区。

Founded in 2001. 20years experience Over 60 patent products

15000 daily output

100% inspection before shipment OEM&amp;ODM

30000M<sup>2</sup> factory workshop

500 employee

**主要展品 /Products**

筋膜枪,按摩棒,按摩披肩,按摩枕,腿部气囊,足疗机,足浴盆

massage gun, handheld massager, massage pillow, neck back massager, air compression leg massager, foot massager, foot bath

## MEIDA 美大

浙江美大实业股份有限公司  
Zhejiang Meida Industrial Co., Ltd

N2-2C51

地址: 浙江省海宁市东西大道 60KM (314400)  
Add: 60km Dongxi Avenue, Haining City, Zhejiang Province  
电话 /Tel: 400-887-3397  
传真 /Fax: 0573-87816391  
网址 /Web: www.meida.com

浙江美大实业股份有限公司, 是集成灶行业的缔造者和领军者。公司于 2012 年 5 月 25 日在深交所 A 股上市, 是集成灶行业首家 A 股上市企业。2003 年, 世界上第一台集成灶产品在美大诞生, 开启下排油烟时代, 2021 年, 美大推出变频集成灶, 变频大吸力 1 秒吸油烟, 引领集成灶迈入变频时代! 美大发明了集成灶产品, 开创了集成灶行业, 引领行业高速发展。美大健康环保科技改变了厨房行业同质化发展格局。

Zhejiang Meida Industrial Co., Ltd. is the founder and leader of integrated cooker industry. The company was listed on the A-share market of Shenzhen Stock Exchange on May 25, 2012, and is the first A-share listed enterprise in the integrated cooker industry. In 2003, the world's first integrated cooker product was born in the United States University of America, which started the era of lower emission of oil smoke. In 2021, the United States University of America launched the variable frequency integrated cooker. The variable frequency integrated cooker will suck oil smoke for 1 second, leading the integrated cooker into the era of variable frequency! Meida invented the integrated cooker product, created the integrated cooker industry, and led the rapid development of the industry. Meida Health and Environmental Protection Technology has changed the homogenization development pattern of the kitchen industry.

### 主要展品 /Products

集成灶、集成水槽、蒸箱、烤箱、水槽洗碗机、橱柜、热水器、净水机  
Integrated stove, Integrated flume, Steamer, Oven, Sink dishwasher, Kitchen cabinet, Gas water heater, Water purifier

## Medal 美多

浙江美多电器有限公司  
medal

N2-2F81

地址: 浙江省绍兴市嵊州市经济开发区浙锻路 168 号 (312400)  
电话 /Tel: 057583006662  
传真 /Fax: 057583006663  
网址 /Web: www.medaldq.com

浙江美多电器有限公司始创于 1989 年, 于 1998 年正式进入厨卫电器行业, 是中国厨卫电器行业的佼佼者和集成灶产品的行业引领者, 已累计为中国上千万家庭厨房提供解决方案, 建厂至今已有 30 年专业历史, 是国内厨电行业的知名制造商。经营的产品主要有集成灶、吸油烟机、燃气灶具等厨房用品, 目前已发展成为集产品设计、研发、制造、营销、服务于一体的现代化厨卫电器企业。

公司秉承品质第一, 客户至上的方针。  
medal

### 主要展品 /Products

X6D,Q9M 一级能效, 大火力 5.2kw, 吸力大, 噪音低, 氛围装饰灯, 不锈钢无指纹纳米技术, 置物台保

温功能, 蒸汽风轮清洗技术, 时尚大气, 智能语音控制, 操作简单, 安全方便, 防火墙功能, 科大讯飞语音识别技术  
X6D,Q9M

## MAKEGOOD

美国 | 前置过滤器  
浙江美国科技有限公司

N4-4A01

地址: 浙江省绍兴市诸暨市店口镇解放路 177 号  
电话 /Tel: 0571-82813837  
网址 /Web: www.makergood.com.cn

浙江美国 | 聚焦净水事业, 专注前置过滤器代工, 从配件到整机全工序自主制造, 突出成本与品质共存的核心竞争优势, 致力打造 10w m<sup>2</sup>全工序代工平台

### 主要展品 /Products

前置过滤器

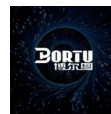

浙江梦享电器有限公司

N2-2A47

地址: 浙江省杭州市临平区运河街道庙河路 9 号 (310000)  
电话 /Tel: 13185077250  
传真 /Fax: 057687056668  
网址 /Web: www.bortu.cn

浙江省梦享电器有限公司是一家专业从事厨房空调产品开发和制造的科技型企业, 以科技带来美好生活为愿景, 致力于为用户提供能够让生活变得更美好的产品。公司现有台下式厨房空调、壁挂式厨房空调、水槽式厨房空调和厨房空调集成水槽四大系列产品, 均采用无外机一体式设计, 安装方便; 同时设置可拆卸油烟滤网, 不惧厨房油烟污染; 让用户夏天做饭不再热。

### 主要展品 /Products

厨房“新物种”博尔图无外机厨房空调, 一键触控开启, 免受厨房“烤”验; 强劲制冷, 享受厨房清凉; 不惧油烟, 长效守护厨房; 独立台嵌两用, 新旧厨房都能装。



浙江米技创意设计有限公司  
zhejiangmijicreativeDesignco., LTD

E2-2A10 2A11

地址: 浙江省金华市永康市经济开发区华夏路 9 号 (321307)  
电话 /Tel: 13757919177  
传真 /Fax: 057985190177  
网址 /Web: www.cokwer.com



浙江米技创意设计有限公司; 日本进口高端锅具 (凡奈尔 cokwer)——日本网红潮品 (哈迪熊 hardybear)——品牌贴牌米技设计——公司位于永康市总部中心金座大厦 19 楼, 联系电话: 13757919177.

**主要展品 /Products**

进口高端锅具



**浙江弩牌电器有限公司**

**Zhejiang Crossbow Brand Electric Appliance Co.,Ltd**

**E1-1E81**

地址: 浙江省武义县邵阳北街 73 号

Add: 73 Shaoyang North Street, Wuyi, Zhejiang Province, China

电话 /Tel: 057987728866

网址 /Web: <http://cn.cncrossbow.com/>

浙江弩牌电器有限公司成立于 2004 年, 位于浙中温泉小镇武义, 是一家专业设计、研制、生产、销售智能生活电器及智能集成电路等产品的创新技术型企业。

公司具有博士带队的技术研发人员 40 多人, 并拥有自主知识产权两百多项, 同时获得德国 IF、红点等设计大奖。产品通过全球各国认证并严格按认证要求生产。

公司主导制定“浙江制造”《无叶风扇》标准并通过国家高新企业认定。

Zhejiang Crossbow Brand Electric Co., Ltd. was established in 2004. It is an innovative enterprise integrating design, sales and production and comprises five subsidiaries across a broad spectrum of businesses: JINQUAN Technology, SHAOCHUANG Industry and Trade, HANGKONG CROSSBOW BRAND, DELICACY E-commerce, covering a total area of 35,000 square meters.

The company's main business is smart home appliances and smart integrated circuits.

**主要展品 /Products**

无叶风扇

Bladeless fan



**浙江鹏孚隆新材料有限公司**

**Zhejiang Pfluo New Materials Co., Ltd.**

**W5-5C61 5C62**

地址: 浙江省金华市婺城区花台路 588 号 (321000)

Add: No.588 Huatai Road, Wucheng district, Jinhua, Zhejiang, China. 321000.

电话 /Tel: 13357024788

传真 /Fax: Zhejiang Pfluo Technology Co., Ltd.

网址 /Web: [www.pfluo.com](http://www.pfluo.com)

浙江鹏孚隆新材料有限公司, 是一家立足中国、布局全球的新材料研发制造企业, 公司多年来聚焦于特种聚合物及其相关应用产品开发与制造, 依托产品技术创新与生产装置进步为客户提供优质的解决方案以及高品质的产品输出, 始终致力于打造成为国际一流高分子材料企业。

公司核心产品包括以特种涂料、特种工程塑料为代表的多样化产品, 其应用领域涵盖家电炊具、航空航天、汽车、电子半导体、石油化工、清洁能源和医疗器械等行业。

**主要展品 /Products**

PFLUON 空气炸锅涂层, 材料更新、配方优化, 产品性能全面升级。

光泽提升 35%

耐盐水 ≥48h

洗碗机性能 125 循环提升至 330 循环

使用寿命增加 1 倍



**浙江齐享科技有限公司**

**Zhejiang Litheli Technology Co., Ltd**

地址: 浙江省宁波市海曙区科盛路 255 号 (315000)

电话 /Tel: 400-696-0063

网址 /Web: [www.litheli.cn](http://www.litheli.cn)

Litheli 晓来, 基于标准化清洁能源的物联网科技平台品牌, 致力于为人类提供标准、平台、模块化的清洁能源, 减少对地球资源的索取, 降低碳排放。

Litheli, IoT technology platform brand focusing on standardized clean energy. We are committed to providing standardized, platformized, and modularized clean energy for users all over the world, reducing the resource consumption of mother earth, and lowering carbon emission.

**主要展品 /Products**

以新能源电池为动力的无线电器产品。

Cordless electric appliances powered by new energy battery.



— 千雲鋰 —

**浙江千云锂电气科技有限公司**

**Zhejiang Qianyunli Electric Technology Co., LTD**

**W3-3H97**

地址: 浙江乐清市城东街道永兴一路 16 号 (325600)

Add: No.16.Yongxing First Road.Chengdong Street ,Yueqing City,Zhejiang Province,China

电话 /Tel: 15967734810

传真 /Fax: 057761571018

网址 /Web: <https://shop29257o2r4c181.1688.com/>

浙江千云锂电气科技有限公司, 是一家专业从事物联网传感器及传感技术研发、生产、销售并为企业客户提供技术支持等全套产品解决方案的高新技术企业, 独立设计开发了多款智能应用产品, 产品广泛应用于航天航空、智能家居、消费电子、智慧医疗、环保、消防安防、矿业、电力电子、车联网等多个领域。

Zhejiang Qianyunli Electric Technology Co.,LTD is a high-tech enterprise specializing in the

research and development, production, sales and technical support of the Internet of Things sensor and sensor technology and other complete product solutions. It has independently designed and developed a number of intelligent application products, which are widely used in aerospace, smart home, consumer electronics, smart medical, environmental protection, fire protection, mining, power electronics Internet of Vehicles and other fields.

#### 主要展品 /Products

人体存在传感器、跌倒传感器、跌倒传感器、生命体征传感器、垃圾满溢传感器、土壤水分(氮磷钾)传感器、PIR 红外传感器、门磁传感器、无线水浸传感器、温湿度传感器、烟雾传感器、燃气传感器、co 传感器、声光报警器、co2 传感器

Human presence sensor, PIR sensor, door status sensor, water leak sensor, temperature and humidity sensor, smoke sensor, gas sensor, co sensor, audible and visual alarm, co2 sensor

peropure

清越科技

浙江清越科技有限公司  
PeroPure, Inc

W5-5A41

地址: 上海市普陀区同普路 339 弄浙铁绿城长风中心 2 期北区 3 号楼 504 室 (200062)

Add: Room 504, Building 3, North Zone, Phase 2, Changfeng Center, Lane 339, Tongpu Road, Putuo District, Shanghai

电话 /Tel: 400-900-8956

网址 /Web: <http://www.peidun.cn/>

清越科技 (PeroPure) 孵化于美国硅谷, 是一家专注于电化学技术全场景应用的科技型创新企业。旗下综合空气管理品牌“配盾”, 以斯坦福大学独家 ElectroPero® 专利技术为核心, 综合解决细菌病毒消杀, 甲醛、TVOC 等有害气体去除, 异味去除等空气管理需求。配盾融合机器人技术、人工智能、物联网等前瞻科技, 提供全场景空气健康管理综合解决方案, 带来更安全、更高效、更智能、更环保的空气健康管理革新体验。

Originating in Silicon Valley, the U.S., PeroPure is a tech innovator specializing in all-scenario applications of electrochemical technologies. Its integrated air management brand "Peidun", that centres around Stanford University's ElectroPero® technology, which comprehensively solves miscellaneous air management problems, e.g., viral/bacterial disinfection, the eliminating formaldehyde, TVOC and other hazardous gases, or deodorizing. "Peidun" also integrating the sophistication of progressive technologies such as robotics, AI, and IoT to provide comprehensive solutions for air health management in the whole scene and bring air health management innovation experience that is safer, smarter, as well as more efficient and eco-friendly.

#### 主要展品 /Products

“配盾”旗下所有产品以斯坦福大学独家 ElectroPero® 专利技术, 综合解决细菌病毒消杀, 甲醛、TVOC 等有害气体去除, 异味去除等空气管理需求。

配盾空气消毒机: 适用于客厅、卧室、酒店、餐厅、学校、医院、办公室等室内空间

配盾便携式 / 车载空气消毒机: 适用于桌面、小型空间及车内空间等

配盾智能消毒机器人: 适用于高铁站、机场、医院、实验室、办公大楼、商场、酒店、学校、体育场馆等大型公共空间

All the products of "PEIDUN" built on Stanford University's ElectroPero® technology, which comprehensively solves miscellaneous air management problems, e.g., viral/bacterial disinfection

,the eliminating formaldehyde, TVOC and other hazardous gases, or deodorizing.  
Peidun Air Disinfection System: applies to living rooms, bedrooms, hotels, restaurants, schools, hospitals, offices and other indoor spaces  
Portable/Vehicle-mounted Air Disinfection Device :applies to desks, small spaces and car spaces  
Peidun Intelligent Disinfection Robot: applies to high-speed railway stations, airports, hospitals, labs, office blocks, shopping malls, hotels, schools, stadiums and other large public spaces



浙江群海电子科技有限公司  
Zhejiang Qunhai Electronic Technology Co., Ltd.

N3-3B45

地址: 浙江省平阳县万全镇郑楼标准厂房丰联路 2 号 (325409)

Add: No. 2 Fenglian Rd., Zhenglou Standard Factory, Wanquan, Pingyang, Zhejiang, China

电话 /Tel: 0577-63782008

传真 /Fax: 0577-63782008

网址 /Web: [www.saengq.com](http://www.saengq.com)

我司成立于 2014 年, 占地面积 10000M<sup>2</sup>, 拥有 100 多名员工, 6 条生产线。每年生产超过 75 万台的真空封口机和 240 万平米 (约 420 吨) 的真空袋。

我们的优势:

1. 专注于家用食品真空封口机和密封袋的研发与生产
  2. 许多顶级品牌的供应商, 如美的, 九阳, 乐扣等
  3. 按照 ISO9001: 2015 质量管理体系生产
  4. 通过 CE, ETL, CB 和 FCC 认证, 质量有保证
- 欢迎参观合作。

Founded in 2014, with a registered capital of RMB10,000,000 (equal to USD1,500,000), floor space 10000M<sup>2</sup>, and over 100 employees, 10% of them are engaging in the fields of R&D and QC.

With 10sets of injection molding machine and 4 assembling lines, 750,000 pieces of vacuum sealer machine and around 2400000 square meters (420,000kg) of vacuum bag (roll) were made annually.

Whole production and QC process are operated under ISO9001:2015 quality management system. Our BSCI certification was renewed in Nov. 2021.

Our core competitiveness:

- 1) Focusing on household food vacuum sealer and sealing bags
  - 2) Verified supplier of top brands, e.g. Midea, Joyoung, Locknlock
  - 3) Made according to ISO9001:2015 quality management system
  - 4) Vacuum sealer pass CE, ETL, CB and FCC product certification
  - 5) Exported mainly for B2C e-commerce since foundation in 2014
- Welcome to visit our website: [www.saengq.com](http://www.saengq.com), and cooperate with us.

#### 主要展品 /Products

真空封口机, 家用真空封口机, 家用真空食品封口机, 真空食品封口机, 真空包装机, 家用真空包装机, 真空食品包装机, 家用真空食品包装机, 手持式真空机, 食品封口机, 真空保鲜机, 打奶器, 打蛋器, 绞肉机, 真空袋, 真空封口袋, 真空食品袋, 真空拉链袋, 真空卷袋, 真空保鲜袋

Vacuum sealer, vacuum food sealer, vacuum sealer machine, vacuum food sealer machine,



household vacuum sealer, household vacuum seler machine, vacuum sealing machine, household vacuum sealing machine, household vacuum food sealing machine, vacuum food sealing machine, vacuum packaging machine, household vacuum packaging machine, vacuum food packaging machine, household vacuum food packaging machine, handheld vacuum machine, food sealing machine, vacuum Fresh-keeping machine, milk beater, egg beater, meat grinder, vacuum bag, vacuum seal bag, vacuum food bag, vacuum zipper bag, vacuum roll bag, vacuum fresh-keeping bag.

## SENG 森歌

高端集成灶品牌

### 浙江森歌智能厨电股份有限公司

Zhejiang Seng Smart Kitchen Appliance Co., Ltd

N2-2C71

地址: 浙江省嵊州市经济开发区浦东大道 138 号森歌电器

电话 /Tel: 18069563111

森歌是一家以智能厨房厨电为核心业务的全球品质厨房生活解决方案服务商。专注于高品质厨房生活的研究,产品线覆盖集成灶、集成洗碗机、集成水槽、嵌入式洗碗机、嵌入式蒸烤箱、燃气热水器、高端不锈钢橱柜、净水器 8 大厨房产品。作为国家高新技术企业,森歌建有工业 4.0 智能厨电产业园、CNAS 国家认可和 Intertek 授权双重认证卫星实验室,参与了二十多项国家、行业、地方标准的起草和修订,是高端厨房电器专业品牌。

#### 主要展品 /Products

产品线覆盖集成灶、集成洗碗机、集成水槽、嵌入式洗碗机、嵌入式蒸烤箱、燃气热水器、高端不锈钢橱柜、净水器 8 大厨房产品

## 商林®

SHANGLIN

### 浙江商林科技股份有限公司

N2-2B57

地址: 浙江省诸暨市兆山路 2 号 (311800)

电话 /Tel: 15967544441

浙江商林科技股份有限公司是一家专业的电子化学品生产服务企业。在电子化学品领域、新能源汽车、轨道交通等领域都有所建树。目前主要有三防漆、热管理产品、电子清洗剂、润滑脂、导电胶、灌封胶、粘结构用胶等系列产品。

#### 主要展品 /Products

产品主要有三防漆、热管理产品、电子清洗剂、润滑脂、导电胶、灌封胶、粘结构用胶等系列产品

## Gebony® 吉柏尼

### 浙江绍兴吉柏尼智能电器有限公司

N2-2B33 2B34

地址: 浙江绍兴市越城区沥海街道繁荣路 11 号 (312000)

电话 /Tel: 13957515986

传真 /Fax: 0575-88758812

公司致力于 全智能生活电器的产品研发,智能制造的零部件制造能力,自动化生产的多条流水线、实现从研发、模具制造、自主组装的全面生产能力。自有电商团队运营、实现线上产品全覆盖,线下渠道为辅的销售新模式。

#### 主要展品 /Products

多能料理快锅,产品实现蒸煮焖炖、压力、火锅 全集成,基本实现国人 90% 的日常生活需要,节省厨房空间,全能更实惠、

## SUPOR 苏泊尔

### 浙江绍兴苏泊尔家居用品有限公司

E2-2C11

Zhejiang Shaoxing SUPOR household products Co., Ltd

地址: 浙江省绍兴市越城区斗门街道世纪西街 3 号 (312000)

Add: No. 3, Shiji West Street, Doumen street, Yuecheng District, Shaoxing City, Zhejiang Province

电话 /Tel: 0571-86858778

传真 /Fax: 0571-86858899

网址 /Web: www.supor.com.cn

苏泊尔是知名的综合性大众家居用品品牌,控股股东法国 Groupe SEB 集团始创于 1857 年,160 余年来一直致力于为全球消费者创造更美好的生活。旗下包含 Tefal、WMF、拉歌蒂尼等 30 个子品牌,每年上千个新品上市,产品涵盖烹饪用具、厨房电器、家庭与个人护理电器等多个领域。

有巧思 无难事,我们一直在路上。

苏泊尔是知名的综合性大众家居用品品牌,控股股东法国 Groupe SEB 集团始创于 1857 年,160 余年来一直致力于为全球消费者创造更美好的生活。旗下包含 Tefal、WMF、拉歌蒂尼等 30 个子品牌,每年上千个新品上市,产品涵盖烹饪用具、厨房电器、家庭与个人护理电器等多个领域。

有巧思 无难事,我们一直在路上。

#### 主要展品 /Products

电饭煲 / 主厨机 / 电压力锅 / 电炖锅 / 电蒸锅 / 电火锅 / 电热饭盒 / 破壁机 / 榨汁机 / 电水壶 / 养生壶 / 料理机 / 豆浆机 / 母婴电器 / 电磁炉 / 煎烤机 / 烤箱 / 空气炸锅 / 空气净化器 / 吸尘器 / 蒸汽拖把 / 蒸汽清洁机 / 除螨机 / 挂烫机 / 电熨斗 / 吸油烟机 / 燃气灶 / 消毒柜 / 净水器 / 蒸汽炉 / 电烤箱 / 蒸烤一体机 / 集成灶 / 电热水器 / 燃气热水器  
电饭煲 / 主厨机 / 电压力锅 / 电炖锅 / 电蒸锅 / 电火锅 / 电热饭盒 / 破壁机 / 榨汁机 / 电水壶 / 养生壶 / 料理机 / 豆浆机 / 母婴电器 / 电磁炉 / 煎烤机 / 烤箱 / 空气炸锅 / 空气净化器 / 吸尘器 / 蒸汽拖把 / 蒸汽清洁机 / 除螨机 / 挂烫机 / 电熨斗 / 吸油烟机 / 燃气灶 / 消毒柜 / 净水器 / 蒸汽炉 / 电烤箱 / 蒸烤一体机 / 集成灶 / 电热水器 / 燃气热水器

**SANFER 帅丰电器****605336.SH****浙江帅丰电器股份有限公司****N2-2F51**

地址: 浙江省嵊州市经济开发区城东区 (312400)

电话 /Tel: 4006969666

传真 /Fax: 0575-83539088

网址 /Web: www.sanfer.com

浙江帅丰电器股份有限公司成立于1998年,是集集成灶领域首个CCTV大国品牌企业,拥有3家现代化的集成灶专业工厂。2020年10月19日帅丰电器在上交所挂牌敲锣,成为集成灶板块首家主板上市企业,帅丰拥有10项中国发明专利,139项中国实用新型专利,138项中国外观设计专利,根据欧睿国际调研数据显示,帅丰蒸烤一体集成灶2019年、2020年、2021年连续三年全国销量领先。

**主要展品 /Products**

X1 双子星蒸烤同步款集成灶、S63 双子星蒸烤同步款集成灶

  
美森
**浙江索拉卡科技有限公司****E3-3F81****MSN**

地址: 浙江省杭州市余杭区联创街153号丽水数字大厦B702 (310000)

电话 /Tel: 0571-87808930

网址 /Web: http://www.msnbeauty.com/

美森MSN品牌成立于1998年,深耕个人护理小家电行业,致力于缔造个人护理领域的世界级中国品牌,做中国个护的“守夜人”。拥有3大生产基地,业务遍及49个国家,并与华为HiLink、荣耀、小米有品生态战略合作。多年来,美森MSN品牌大力助推个人护理行业发展,荣获全球发明专利46项,设计专利262项,实用新型专利124项,国外专利7项,PCT合作专利体系6项,成为中国优秀个护企业的代表。

**主要展品 /Products**

美森小飞云PS8209剃须刀,美森智能电动剃须刀M3,美森/荣耀亲选便携电动剃须刀M2,美森/小米有品多功能鼻毛器H3,美森华为HiLink智能牙刷R1

  
探享家
**浙江探享家智能科技有限公司****W5-5B15 5B14**

地址: 浙江省义乌市福田街道物华路22号

电话 /Tel: 13819952662

浙江探享家智能科技有限公司成立于2021年,是一家研发设计生产主要产品有智能洗地机、真空吸尘器,其它清洁电器研发等清洁用品。主攻家用智能清洁类电器的创新应用。公司拥有多项发明专利,依托强大的研发团队、卓越的服务品质,不断追求技术的创新与突破,旗下品牌TOHOME探享家以“健康绿色,舒适生活”为品牌理念,力争成为每个家庭健康生活环境的管家。

**主要展品 /Products**

探享家智能无线洗地机TH9

**功能及特点:**

1. 代替扫把代替拖把,干湿垃圾一遍就过,顽固垃圾也不怕
2. 扫地拖地同时进行,吸拖洗一步到位。跟着机器走一遍扫地拖地同时进行,并且实时清洗滚刷,保持滚刷一直都是干净的清理地面
3. 不用自己清洗滚刷,放入底座,一键自清洁,机器自己清洗滚刷

  
田螺云厨
**浙江田螺云厨科技有限公司****N3-3G81****Zhejiang Kitchen Idea Technology Co., Ltd.**

地址: 杭州市滨江区长河街道建业路511号华业大厦25层2510室 (310000)

Add: Room 2510, Huaye building, No. 511 Jianye Road, Changhe Street,

Binjiang District, Hangzhou.

电话 /Tel: 0571-88909526

网址 /Web: http://www.kitchenidea.com.cn/#/CloudKit

浙江田螺云厨科技有限公司,位于杭州滨江高新区,是一家专注于高端厨电研发制造,健康生态管理的高科技企业。田螺云厨致力于打造全新的未来厨房生态,以科技驱动生活,用现代化科技让古代神话照进现实,让亿万家庭拥有属于自己的田螺姑娘。

**主要展品 /Products**

田螺云厨多功能烹饪机器人是一款为解决厨房油烟、厨房家电多、健康饮食问题、合理使用零碎化时间的解决方案产品。

**浙江桐晟来工贸有限公司****N3-3A40**

地址: 浙江省金华市武义县白洋街道泉深线万石院段五号武义浦峻小微科技园3B幢 (321300)

电话 /Tel: 0579-87220510

传真 /Fax: 0579-87220510

浙江桐晟来工贸有限公司于2022年成立,是一家工贸一体的公司。公司位于浙江省金华市武义县白洋街道泉深线万石院段5号武义浦峻小微科技园3B幢,主要生产经营炒锅,乌龟锅,多功能料理锅,电烤肉盘等一系列厨房用具。本公司多年致力于产品的创新与质量发展,所有产品都拥有自己的专利权。切实积极推进与各公司,厂家的合作。

Zhejiang Tongshenglai Industry and Trade Co., LTD., established in 2022, is a company integrating industry and trade. The company is located in Building 3B, Wuyi Pujun Small Micro Science and Technology Innovation Park, No.5 Wanshiyuan Section, Quanshen Line, Baiyang Street, Wuyi County, Jinhua City, Zhejiang Province. The company mainly produces and operates a series of kitchen utensils, such as frying pan, turtle pot, multifunctional cooking pot, electric barbecue plate and so on. The company has been committed to product innovation and quality development for many years, all products have their own patents. Actively promote cooperation with companies and manufacturers.

**主要展品 /Products**

炒锅,乌龟锅,多功能料理锅,电烤盘,户外烤盘,咖啡炉,玉米烧,小奶锅等

# iHomey

浙江途康家居用品有限公司

ZHEJIANG IHOMEY HOUSEWARE CO., LTD

W3-3B14

地址: 浙江省永康市金山西路 568 号 (321300)

Add: No.568, Jinshan West Road, Yongkang City, Zhejiang Province, China

电话 /Tel: 0579-87216671

传真 /Fax: 0579-87216670

网址 /Web: www.ihomey.cn

浙江途康家居用品有限公司坐落于中国五金之都 - 浙江省永康市, 是一家集科研、生产、销售为一体的现代型企业, 主要经营家居用具、家用电器, 电子产品等新型产品, 无叶风扇是我公司自 2010 年始研发的产品, 经过不断改进和优化, 目前已实现量产并得到国内外市场的肯定。

ZHEJIANG IHOMEY HOUSEWARE CO., LTD focuses on producing smart home products and providing good service to all our customers. We began with home appliance design, research and production; our customers had been spread all over the world. Combine mobile Internet technology, icloud service technology with our years' industrial design and production experience after 8 years' growth, we achieve our goal of transformation and upgrade successfully. We have become an integrated company which provides smart home products and related service, traditional home appliance updating and smart home products production.

We have our own professional developing team and build long term cooperation relationship with our customers by providing good service. Our products are sold all over the world including America, Europe, Latin America and Asia markets and become the best sellers in the markets.

## 主要展品 /Products

无叶风扇, 筋膜枪, 消毒机, 暖风机, 制冷机

Leafless fan, fascia gun, disinfection machine, heater, refrigerator

# Torposh

浙江霉博士科技有限公司

E1-1B21

地址: 浙江省金华市宾虹东路 358 号嘉福商务大厦 2 幢 564 室 (321015)

电话 /Tel: 057989177780

传真 /Fax: 057989177782

浙江霉博士科技股份有限公司, 是一家集研发、设计、生产、销售、服务为一体的小家电与清洁用品的企业。公司主营空气炸锅, 厨师机等小家电, 还有吸尘器, 空气净化器等新型智能健康产品。

## 主要展品 /Products

空气炸锅, 厨师机, 吸尘器, 空气净化器等

# MiMO

浙江万陌科技有限公司

E3-3F86

地址: 浙江省杭州市滨江区长河街道江虹路 333 号研祥科技大厦 A 幢 20 层 2005 室 (310000)

电话 /Tel: 0571-86771976

传真 /Fax: 0571-86771976

万陌科技是一家集研发创新、生产、销售、服务为一体, 具有互联网思维的专注于小家电护理领域的平台。公司主营: 口腔护理, 家庭清洁, 个人护理, 衣物护理, 美容护理, 宠物护理等 6 大系列智能家电产品, 超 100 多种型号; 拥有佛山研发, 宁波制造, 杭州销售三大基地同步运作; 产品销售区域遍布欧洲、北美洲、南美洲、亚洲、大洋洲和非洲六大洲; 国内知名一线品牌: 美的、苏泊尔、海尔等的核心供应商, 达成常年战略合作协议。

## 主要展品 /Products

公司主营: 口腔护理, 家庭清洁, 个人护理, 衣物护理, 美容护理, 宠物护理等 6 大系列智能家电产品, 超 100 多种型号。

# TIMEELF 时代精灵

浙江翔龙快洁智能环保科技有限公司

N2-2A15

Zhejiang Xianglong Fast-Clean Intelligent Environmental Protection Technology Co., Ltd

地址: 浙江省宁波市海曙区高桥镇翔龙路 1 号 (315173)

Add: No. 1, Xianglong Road, Gaoqiao Town, Haishu District, Ningbo City, Zhejiang Province

电话 /Tel: 15042469809

网址 /Web: https://www.zjxl.cn/

浙江翔龙快洁智能环保科技有限公司成立于 2021 年, 传承宁波翔龙 20 年的生产制造经验, 拥有恒速直流永磁电机及十级研磨技术。从中国制造到中国创造, 浙江翔龙以创新为理念, 研发人性化、智能化的厨余垃圾处理器, 为国人提供高品质产品及优质服务, 打造健康环保、有品位有文化的生活方式。

Zhejiang Xianglong Kuaijie Intelligent Environmental Protection Technology Co., Ltd. was founded in 2021, inheriting 20 years of production and manufacturing experience of Ningbo Xianglong, with constant speed DC permanent magnet motor and 10-level grinding technology. From "Made in China" to "Created in China", Zhejiang Xianglong takes innovation as its concept, develops humanized and intelligent kitchen waste disposal, provides high-quality products and services for the Chinese people, and creates a healthy, environment-friendly, tasteful and cultural lifestyle.

## 主要展品 /Products

厨余垃圾处理器

Kitchen waste disposal



### 浙江欣轮(智能科技)集团

W5-5B23 5B23 5B24

地址: 浙江省宁波慈溪市新浦镇新新路 373 号 (315322)

电话 /Tel: 4008408099

网址 /Web: www.cndingliu.com

集团位于浙江省宁波慈溪市, 是一家有着超过 12 年专业设计与制造户外取暖器的企业, 阿里巴巴的金品诚企供应商; 专业生产户外取暖器;

集团拥有完整的生产管理 ERP 系统, 有先进的注塑机、冲压机、喷漆机等设备, 工厂通过了 BSCI 和 ISO 的体系认证, 产品取得了 CCC 认证以及众多国际专业机构比如 SGS, TUV, ITS 等实验室的认证, 产品有 CCC、CE、GS、EMC、CB 等多项证书。出口北美, 欧洲等 60 多个国家

#### 主要展品 /Products

户外取暖器, 包括吊顶, 壁挂, 便携式, 落地款

室外 6A 高品质

超能效超温暖超快热

新型碳纤维柔性速热, 温暖不延时, 近 20 年碳纤维发热底蕴, 柔光不扎速热科技, 电流平稳。跟湿冷说拜拜。

碳纤维发热体的电热转换率达 95% 以上, 重电 2526.16 防盗器材工业设计。

高颜值 高防水 高质量

IPX5 防水设计, 全天候室外使用



为油烟机换代而生

### 浙江新帝电器制造有限公司

N2-2B15 2B16

ZHEJIANG XINDI ELECTRICAL APPLIANCES MANUFACTURING CO.,LTD.

地址: 浙江省绍兴市嵊州市三江街道三江工业区

电话 /Tel: 18676003639

新帝公司成立于 2009 年, 是集研发、生产、销售于一体的新型厨电制造企业, 多年来倾力于厨电技术革新, 并以精心研发的产品和诚挚贴心的服务在行业赢得良好口碑。目前拥有 176 项专利、652 套精密模具和 11 条全自动机器人生产线, 是国家级高新技术企业。专业打造猛火超能电磁灶、3 净静音油烟机、快煮粒粒香电饭煲三大系列高品质差异化厨电升级换代产品, 率先掀起厨电行业技术大革命!

#### 主要展品 /Products

抽油烟机



### 浙江亿宝科技有限公司

ZHEJIANG YIBAO TECHNOLOGY CO.,LTD

W2-2A12

地址: 浙江省乐清市虹桥镇幸福东路 1318-2 号

电话 /Tel: 0577-57127817

网址 /Web: www.ibao.com.cn

浙江亿宝科技有限公司是一家专业从事设计、开发、制造电子电器开关、微电机配件及精密模具、非标自动化设计生产的企业, 创立千 1998 年。所生产的产品广泛应用千家用电器、汽车部品、办公设备、物联网、医疗仪器、测量仪器、工业控制设备等。我司已通过质量、环境与职业健康安全管理体系认证; 产品获得了国际著名安全机构认可及认证。我们以专业的设计, 稳定的质量, 合理的价格, 快捷的交付, 真诚服务于每个客户!

#### 主要展品 /Products

专业从事设计、开发、制造电子电器开关、微电机配件及精密模具、非标自动化设计生产的企业, 创立千 1998 年。所生产的产品广泛应用千家用电器、汽车部品、办公设备、物联网、医疗仪器、测量仪器、工业控制设备等。



### 浙江亿田智能厨电股份有限公司

ZHEJIANG ENTIVE SMART KITCHEN APPLIANCE CO., LTD.

N2-2F71

地址: 浙江省绍兴市嵊州市浦口街道浙锻路 68 号 (312400)

电话 /Tel: 4001057878

传真 /Fax: 0575-83260380

网址 /Web: www.entive.com

浙江亿田智能厨电股份有限公司创立于 2003 年, 是一家专业研发、生产、销售、服务为一体的高端厨电及不锈钢橱柜集成解决方案的制造企业。亿田于 2020 年 12 月 3 日在深圳证券交易所创业板上市股票代码为 300911。作为中国厨具之都(嵊州)厨具行业协会会长单位, 集成灶行业内唯一获得全省最高质量奖 - 浙江省人民政府质量奖获奖单位, 新时代下亿田始终以高质量的卓越绩效管理模式和雄厚的创新技术实力推动行业可持续发展。

Zhejiang Entive Smart Kitchen Appliance Co., Ltd was established in 2003, who is a manufacturer professional in R&D, manufacturing, marketing and servicing of high-end kitchen appliances and integrated solution for stainless steel kitchen cabinet. Company is continuing to process internal industrialization, automation, informatization and intelligent. Entive has been launched in ChiNext Shenzhen in 3rd December 2020 with the code 300911. With the mission to create the harmless kitchen environment, and based on the value of integrated technology to recreate the kitchen space, as the president member of capital city (Shengzhou City) kitchen appliance of China and the only one who awarded as Zhejiang Provincial People's government Quality Award in the industry, Entive is always trying to stimulate the industry towards sustainable development with her high-quality performance excellence management and strong innovation of technology in the new era.

#### 主要展品 /Products

集成灶、集成水槽、不锈钢橱柜、油烟机、燃气灶、消毒柜、洗碗机、蒸箱、烤箱、燃气热水器、净水器、垃圾处理

integrated cooker, integrated sink, stainless steel cabinet, range hood, gas hob, sterilizer, dishwasher, steam oven, oven, gas water heater, water purifier, waste disposer



## YIHOO

浙江易豪电子有限公司  
ZHEJIANG YIHOO ELECTRIC CO., LTD

W2-2B27

地址: 宁波慈溪市桥头镇吴山南路 1001 号 (315317)

Add: No.1001, South WuShan Road, Qiaotou, CiXi, Ningbo, P.R.China

电话 /Tel: 057463699300

易豪主要专注于真空保鲜领域, 致力于打造质量合格、可靠的智能保鲜产品, 延长食品保鲜周期。通过延长食物的食用时间来缓解目前浪费状况。此外, 毫无疑问, 保存对于保持食物的风味和营养是很重要的。高品质的真空保鲜产品可以大大延缓食物与空气的化学反应, 保证食物的口感和营养。易豪希望利用真空保存技术创造出适合大众的产品, 满足用户的各种存储需求, 在提高用户生活品质 and 便捷性的同时, 利用技术为社会的可持续发展做出贡献。

Yihoo mainly focuses on the vacuum preservation field, and is committed to creating qualified and reliable intelligent preservation products to extend the food preservation cycle. Reduce current waste by making food last longer. In addition, there is no doubt that preservation is important to maintain the flavor and nutrition of food. High quality vacuum preservation products can greatly delay the chemical reaction between food and air, and ensure the taste and nutrition of food. Yihoo hopes to use the vacuum preservation technology to create products suitable for the public, meet the various storage needs of users, improve the quality of life and convenience of users, at the same time, use technology to contribute to the sustainable development of society.

## 主要展品 /Products

电动真空储物罐

电动真空红酒塞

电动真空储粮桶

Electric vacuum storage canister

Electric vacuum wine plug

Electric vacuum storage barrel

浙江银升新材料有限公司  
ZHEJIANG YINSHENG NEW MATERIALS CO.,LTD.

W1-1D81

地址: <http://www.yin-sheng.com/> (314100)

电话 /Tel: 13600553229

传真 /Fax: 573-89115866

网址 /Web: <http://www.yin-sheng.com/>

浙江银升新材料有限公司是长三角地区玻璃深加工行业中的旗舰型企业。公司占地约 7.5 万平方米, 现有员工 500 余人。我司引进大量国内外先进玻璃深加工机器设备, 意大利保持罗全自动切割机、因特马克 CNC 磨边机等设备, 并设有无尘车间。可完成不同厚度、形状的玻璃的开介、磨边、钻孔、丝印、钢化、贴膜等工艺。公司拥有自主进出口经营权, 产品符合欧盟 ROHS 标准, 已通过英国 BS6206 和欧盟 BS EN 12150 认证。

ZHEJIANG YINSHENG NEW MATERIALS CO.,LTD. is a flagship enterprise in the glass deep processing industry in the Yangtze River Delta. Yinsheng glass covers an area of about 75000

square meters and has more than 500 employees. In order to ensure product quality, we have also introduced a large number of advanced glass deep-processing machines equipment, including Italy's Botero full-automatic cutting machine, intermark CNC edging machine, as well as dust-free silk screen workshop. It can complete various processes of glass with different thickness and shape, such as opening, edging, drilling, silk screen printing, tempering, film coating and so on. The company has the right to import and export its own products meet the ROHS standards of the European Union, and have passed the BS6206 and EU BS EN 12150 certification.

## 主要展品 /Products

厨卫类玻璃主要应用于厨房烟机、灶具、消毒柜、烤箱、微波炉等厨房电器; 家电类玻璃主要应用于电视机底座、显示器屏幕、音响、电子秤、冰箱面板、洗衣机面板等家用电器;

Kitchen and bathroom glass is mainly used in kitchen appliances such as kitchen range hood, stove, disinfection cabinet, oven and microwave oven; Home appliance glass is mainly used in TV base, display screen, sound, electronic scale, refrigerator panel, washing machine panel and other home appliances;

浙江优食环境科技有限公司  
Zhejiang UISH Environmental Technology Co., Ltd.

N3-3E91

地址: 浙江省宁波杭州湾新区滨海大道 298 号 (315336)

Add: 298 Binhai Avenue, Hangzhou Bay New District, Ningbo, Zhejiang Province

电话 /Tel: 0574-63097127

传真 /Fax: 0574-63097127

网址 /Web: <http://ushi.net.cn/col.jsp?id=103>

浙江优食环境科技有限公司是一家集研发、生产、销售、服务于一体的高新技术企业, 拥有十万级洁净生产车间和先进管理水平, 已获得 ISO9001、ISO14001、ISO45001 三大体系认证。经过多年研究, 现已实现 UISH MOH+® 食材净化技术的突破, 可有效杀灭和去除食材表层的细菌、病毒、农药残留、激素、抗生素、防腐剂、添加剂和霉菌毒素等有害物质, 其中微纳米气泡活氧等部分技术达到国际先进水平。

Zhejiang UISH Environmental Technology Co., Ltd. is a high-tech company integrating R & D, production and sales. It is committed to enter the food health industry with the opportunity of food disinfection and purification under global food pollution. With 600000-level aseptic and dust-free production workshop and advanced management level, it has been approved by the certification body. The company has successively obtained three system certifications of ISO9001, ISO14001 and ISO45001. After years of research on food purification technology, the company has achieved a breakthrough in three-layer purification technology, which is to remove agricultural residues, bacteria, viruses, aflatoxin, antibiotics, hormones and other harmful substances through micro nano bubbles, ozone (O3), hydroxyl radicals (·OH), so as to provide food safety guarantee for people.

## 主要展品 /Products

优食净食机分为家用系列、商用系列。1、家用分体式净食机主要有 US-MOHO1、US-I05、US-Z01 等, 采用国际先进的 UISH MOH+® 食材净化技术, 适合家庭厨房场景。2、家用箱体式净食机有 US-B02-A, 桶机分离, 节省空间。3、家用水槽一体式净食机有 US-TO1, 集成一体, 高效净化。4、商用净食机主要有 US-CO1、US-CO2 等, 有效满足单位后厨、餐厅厨房的食材净化需求。

The products are divided into household series and commercial series.

1. Household split-type food purifiers mainly include US-MOHO1, US-I05, US-I08, US-Z01, etc., using the internationally advanced UISH MOH+ © The food purification technology is suitable for the family kitchen scene.
2. The domestic box-type food purifier has US-B02-A, and the bucket machine is separated to save space.
3. The household sink integrated food purifier has US-TO1, integrated and efficient purification.
4. Commercial food purifiers mainly include US-CO1, US-CO2, US-CO3, etc., which are the defenders of public food safety and effectively meet the demand for food purification in the unit kitchen and restaurant kitchen.

YOO LADY  
悦夫人

### 浙江悦夫人智能科技有限公司

E1-1B06

地址: 浙江省慈溪市崇寿镇永清南路 138 号  
电话 /Tel: 15757801177  
网址 /Web: www.yooladycare.com

浙江悦夫人智能科技有限公司是一家以研发, 销售和品牌运营为核心的智能科技公司。

公司以“成为一家受人尊重的百年企业”为愿景, 以“致力于用科技改善人们的生活品质”为企业使命, 打造悦夫人在客户心中值得信赖的品牌形象。

Yoolady 品牌创始人凭借对家居清洁需求的深刻了解, 立志提供专业的清洁表现。打造从无线吸尘器制造到智能洗地机; 从智能洗地机到扫地机器人的完整产品线。

#### 主要展品 /Products

YOO LADY 悦夫人 V70 无线手持智能吸尘器

ZHENGKE®  
ELECTROMOTOR

### 浙江正科电机有限公司

W1-1B06

地址: 乐清市北白象镇坂塘工业区沙洪路 225 号  
电话 /Tel: 13757792227  
网址 /Web: www.zhengke.cn

浙江正科电机有限公司是一家集科研、制造、销售于一体, 有着多年机电制造经验的现代化高新技术企业, 公司青山绿水环绕, 环境十分优美, 毗邻有“世界地质公园”之称的中国著名旅游胜地——雁荡山风景区。甬台温高速公路、104 国道横贯全境, 距温州机场只有半小时车程, 交通十分便利。全体正科人恭候国内外客户的垂询和惠顾, 期待与您携手并进、共创辉煌!

#### 主要展品 /Products

主要是生产微型直流减速电机, 推杆电机, 直流行星电机, 涡轮蜗杆电机等

浙江致广科技有限公司  
Zhejiang zhiguang technology co., ltd

### 浙江致广科技有限公司 ZheJiang ZhiGuang Technology CO.,LTD

W5-5B45

地址: 浙江省乐清市翁洋街道九新路 88 号 (325600)  
Add: No.88 JiuXin Road WengYang Street, Yueqing City, Zhejiang China  
电话 /Tel: 0577-62812072  
传真 /Fax: 0577-62812073  
网址 /Web: www.cnzgzd.com

浙江致广科技有限公司是专业致力于臭氧发生器、负离子发生器、等离子发生器及控制板 PCBA 等产品的研发、制造、销售和服务为一体的高新技术企业。

公司臭氧系列产品广泛应用于医疗卫生、饮用水消毒杀菌、生物制品、污水处理、食品饮料加工、制药、果蔬冷藏与保鲜、空气消毒杀菌净化, 家居、家电、家具、卫浴、公共场所、宾馆、学校、养殖等领域的空气杀菌除臭和水处理净化。并可以根据不同客户的需求, 设计各类非标产品。

Zhejiang Zhiguang Technology Co., Ltd. is a high-tech Enterprise specialized in R & D, manufacturing, sales and service of ozone generator, negative ion generator, plasma generator and PCBA. The company's ozone series products are widely used in medical hygiene, drinking water disinfection and sterilization, biological products, sewage treatment, food and beverage processing, pharmaceutical, fruit and vegetable refrigeration and preservation, air disinfection and sterilization and purification, home, home appliances, furniture, sanitary ware, public places, hotels, schools, aquaculture and other areas of air sterilization deodorization and water treatment purification. And according to the needs of different customers, the design of various non-standard products.

#### 主要展品 /Products

臭氧发生器、负离子发生器、等离子发生器及控制板 PCBA  
ozone generator, negative ion generator, plasma generator and PCBA.

中广 OUTES  
欧特斯

### 浙江中广电器集团股份有限公司 ZHEJIANG ZHONGGUANG ELECTRIC Co., Ltd.

W1-1E61

地址: 浙江省丽水市水阁工业园区云景路 96 号 (323000)  
Add: No. 96 Yunjing Road, Shuige Industrial Park, Lishui City, Zhejiang Province  
电话 /Tel: 0578-2355511  
传真 /Fax: 0578-2355522  
网址 /Web: www.outes.com

浙江中广电器股份有限公司是一家以空气能技术为核心, 集中央地暖中央空调中央热水中央净水、中央新风等产品研发、生产、销售、服务于一体的国家高新技术企业。公司注册资金 12100 万, 生产基地占地面积 351 亩, 建筑面积达 50 万平方米, 拥有国际一流的生产流水线及国内领先的 CNAS 智能实验室群, 是目前亚洲规模一流的舒适家居系统和商用暖通热水综合解决方案供应商。

Zhejiang Zhongguang Electric Appliance Co., Ltd. is a national high-tech enterprise with air energy technology as the core, integrating the research and development, production, sales

and service of central floor heating, central hot water, central water purification, central fresh air and other products. The company has a registered capital of 121 million yuan, a production base covering an area of 351 acres, a construction area of 500,000 square meters, a first-class production line and a leading CNAS intelligent laboratory group in China, and is currently a first-class supplier of comfortable home systems and commercial HVAC hot water integrated solutions in Asia.

#### 主要展品 /Products

热泵采暖, 热泵空调, 热泵热水器, 全屋净水, 新风, 全屋智能  
Heat pump heating, heat pump air conditioning, heat pump water heater, whole house water purification, fresh air, whole house intelligence



#### 中讯电子

##### 浙江中讯电子有限公司

##### Zhejiang Zhongxun Electronics Co., Ltd

地址: 浙江省乐清市虹桥镇新丰路 1879 号 (325608)

Add: 1879 Xinfeng Road, Hongqiao Town, Yueqing City, Zhejiang Province

电话 /Tel: 0577-62338777

传真 /Fax: 0577-62338118-8100

网址 /Web: www.zxgroup.com

浙江中讯电子有限公司创立于 1989 年, 公司座落在一乐清市。公司在香港、韩国、广州、深圳、中山、顺德、上海等地设有分支机构。

中讯电子产品以优良的品质, 优越的性价比, 优质的服务畅销国内外。与多家国际知名企业建立了良好的业务合作关系, 并成为这些企业长期合作的首选供方。

中讯电子热忱欢迎国内外客户洽谈合作, 共创美好未来。

Zhejiang Zhongxun Electronics Co., Ltd. was founded in 1989. The company is located in Yueqing City. The company has branches in Hong Kong, South Korea, Guangzhou, Shenzhen, Zhongshan, Shunde, Shanghai and other places.

Zhongxun electronic products sell well at home and abroad with excellent quality, superior cost performance and high-quality service. It has established good business cooperation relations with many international well-known enterprises and has become the preferred supplier for long-term cooperation of these enterprises.

Zhongxun electronics warmly welcomes customers at home and abroad to discuss cooperation and create a better future.

#### 主要展品 /Products

公司专业研发、制造各类 GFCI、PRCD 漏电保护器、耦合器、连接器、跷板开关、微动开关、拨动开关、旋转开关、琴键开关、按钮开关、设备用断路器、电源插座等 200 多种规格产品, 是国内生产器具开关的龙头企业, 也是全国电器附件标准化委员会器具开关分技术委员会委员单位。公司主导产品先后通过 UL、VDE、TUV、KC、ETL、CB、SAA、CCC、CQC 等认证。

The company specializes in R & D and manufacturing more than 200 specifications of GFCI, prcd leakage protector, coupler, connector, rocker switch, microswitch, toggle switch, rotary switch, piano key switch, button switch, equipment circuit breaker, powe

**N2-2B40 2B41 2B42**



##### 甄十信息科技(上海)有限公司

##### Zhenshi Information Technology (Shanghai) Company Limited

地址: 上海市徐汇区漕宝路 401 号 3 号楼 5 楼 (200030)

Add: 5F, Bldg3, No. Caobao Rd, Xuhui District, Shanghai

电话 /Tel: 400-090-8508

传真 /Fax: 400-090-8508

网址 /Web: https://www.xunkids.com/

**W3-3C01**

小寻是一家儿童科技公司, 于 2015 年创立, 由小米、诺基亚、晨兴、顺为资本联合投资, 聚焦于儿童智能手表, 拓展研发儿童生态智能产品, 销往全球 1800+ 城市, 服务超 6000 万家庭用户。目前, 小寻已获得百余项专利以及软件著作权, 取得了儿童智能手表首批 CQC (中国质量认证中心) 认证、ISO27001、ISO27701 等多项权威认证。秉承“奇妙科技, 陪伴成长”的宗旨, 成为持续推动儿童科技领域的领军品牌。

#### 主要展品 /Products

小寻青少年运动手表 Sport6- 运动心率版  
小寻青少年运动手表 Sport6- 大黄蜂限定款  
小寻儿童成长手表 Y2s  
小寻青少年学习手表 YES3Pro  
小寻儿童电话手表 T5  
小寻儿童电话手表 X5  
小寻儿童电话手表 A9  
小寻儿童电话手表 M6  
小寻儿童电话手表 P3  
小寻 AI 学习手表 S5  
小寻 AI 学习手表 P6S  
小寻 AI 学习手表 Z7  
小寻词典笔 Aipen3 pro  
小寻词典笔 Aipen3



##### 镇江东方电热科技股份有限公司

地址: 镇江新区大港镇五峰山路 18 号 (212132)

电话 /Tel: 0511-88981666

传真 /Fax: 0511-83120588

网址 /Web: www.dongfang-heater.com

**W3-3B01**

公司创建于 1992 年底, 是江苏省高新技术企业, 国家级守合同重信用企业, 中国驰名商标, 三项电加热行业标准起草单位之一。2011 年 5 月 18 日, 公司在深圳证券交易所创业板上市, 成为全国首家生产制造电加热器的上市公司。专业制造空调、冰箱、热水器、洗衣机、电烤箱等各类家电、电动汽车、高速列车等配套的电加热产品, 主要客户有海尔、格力、美的、松下、奥克斯、海信、TCL、大金、三星等国内外知名家电企业。



### 主要展品 /Products

年生产超过 1 亿件各类电加热产品, 国内同行业中规模最大, 品种最全、配套供货能力最强、最具有发展潜力的行业龙头企业。



### 郑州炜盛电子科技有限公司

**Zhengzhou Winsen Electronics Technology Co., Ltd.**

**E2-2D81**

地址: 河南郑州高新技术开发区金梭路 299 号 (450000)

Add: NO.299 Jinsuo Road, National High-Tech Zone, Zhengzhou

电话 /Tel: 0371-60932951

传真 /Fax: 0371-60932988

网址 /Web: www.winsensor.com

物联天下, 传感先行。

炜盛科技成立于 2003 年, 是一家集研发、生产、销售及气体传感器应用方案服务为一体的高新技术企业。

公司产品涵盖气体传感器、MEMS、红外线探测、压力、湿度、流量、水质等多门类传感器和应用方案, 共八大系列, 200 多个品类, 可用于 300 余种指标的检测, 广泛应用于工业安全、民用消防、环境保护、家用电器、汽车电子、医疗健康、智慧城市等领域, 并在新的应用方向不断开拓创新。

The world is connected with things, and sensing is the first.

Winsen Technology, founded in 2003, is a high-tech enterprise integrating research and development, production, sales and gas sensor application solutions.

The company's products cover gas sensors, MEMS, infrared detection, pressure, humidity. There are eight series and more than 200 categories of sensors and application solutions for flow and water quality, which can be used for the detection of more than 300 indicators. They are widely used in industrial safety, civil fire protection, environmental protection, household appliances, automotive electronics, medical health, smart cities and other fields, and constantly develop and innovate in new application directions.

### 主要展品 /Products

红外气体传感器、半导体气体传感器、平面半导体气体传感器、催化燃烧式气体传感器、电化学气体传感器、PM2.5 传感器、流量传感器、红外热释电传感器、热电堆传感器、火焰传感器、压力传感器、水质传感器、湿度传感器、MEMS 传感器、热传导气体传感器、热线型气体传感器、车载传感器

Infrared gas sensor, semiconductor gas sensor, planar semiconductor gas sensor, catalytic combustion gas sensor, electrochemical gas sensor, PM2.5 sensor, flow sensor, infrared pyroelectric sensor, thermopile sensor, flame sensor, pressure sensor, water quality sensor, humidity sensor, MEMS sensor, heat conduction gas sensor, hot wire gas sensor and on-board sensor



### 智晶光电股份有限公司

**WiseChip Semiconductor Inc.**

**N1-1B16**

地址: 台湾苗栗县竹南镇科北二路 8 号 (350401)

Add: 8, Kebei RD.2, Science Park, Chu-Nan, Taiwan 350, R.O.C

电话 /Tel: 886-37-587168

传真 /Fax: 886-37-586566

网址 /Web: www.wisechip.com.tw

智晶光电股份有限公司成立于 2005 年 11 月, 以坚强的技术经营团队全速切入光电产业, 致力于有机电激发光显示器 (OLED, Organic Light Emitting Diode) 之研发、设计及制造并行销。

智晶光电可依客户多样化需求提供不同封装方式的有机 EL 显示模组, 并以先进制程技术、生产设备, 能在最短的时间提供客户解决方案以满足客户需求。

WiseChip Semiconductor Inc. was established in November 2005, and has broken into the optoelectrical industry at full speed with a strong technical and management team, devoting itself to the research and development, design, manufacturing, and marketing of OEL (OLED, Organic Light Emitting Diode).

WiseChip Semiconductor Inc. can provide organic EL display modules sealed in different ways based on customer needs, and uses advanced manufacturing technology and production equipment to provide solutions with the shortest time to satisfy consumers.

### 主要展品 /Products

智晶对本业的努力, 坚持深绿色能源产业的有机电发光显示器 (有机发光二极管, 简称 OLED)。经营 0.25 寸至 5.5 寸的 OLED 产品, 其产品为字符型、全彩、屏单色) 屏、区彩屏、屏屏、透明屏等

WiseChip Semiconductor Inc. is a professional manufacturer of OLED. Our main products include OLED Display, Full Color Display, Monochrome Displays, Bendable OLED, Transparent OLED, Matrix OLED, etc. If you are looking for high quality Wide Temperature Range, Icon OLED and Area Color OLED, Manufacturer, please do not hesitate to contact us.

Main Product:

\*Character Type Display

\*Full Color OLED

\*Monochrome Displays

\*Area Color OLED

\*Bendable OLED

\*Transparent OLED



### 中关村在线

**中关村在线**

**ZOL**

**W4-4E01**

地址: 北京市东城区和平里东街 11 号航星科技园航星 3 号楼 5 层

电话 /Tel: 15011411992

网址 /Web: www.zol.com.cn

中关村在线 (ZOL) 创立于 1999 年, 深耕科技垂直领域 23 年, 是致力于新消费新势力生活科技类商品第一导购平台。中关村在线以“帮用户买好产品 帮客户卖好产品”为使命。截止 2022 年 6 月 30 日, 注册用户超 5200 万, 平台每日输出专业文章 900 篇, 月发布专业视频超 460 条, 月覆盖用户达 2.37 亿, UGC 用户日均产出 4500 篇内容, 同时内容覆盖百度、字节系、京东、淘宝、哔哩哔哩等主流平台, 粉丝总量超千万。

### 主要展品 /Products

新消费势力生活科技商品第一导购平台





### 中国船舶集团有限公司第七一八研究所 The 718th research institute of csic

W3-3H81

地址: 河北省邯郸市展览路 17 号

Add: 17 Zhanzhan Road, Handan City, Hebei Province

电话 /Tel: 0310-7189486

传真 /Fax: 0310-7189486

网址 /Web: www.peric.ac.cn

七一八研究所隶属于世界 500 强中国船舶集团有限公司, 创立于 1966 年, 总部位于河北省邯郸市, 是集军民产业的科研开发、设计生产、技术服务于一体的国家重点科研单位。全所现有职工近 2000 人, 其中科技人员 870 多人, 享受国家政府补贴 30 人, 研究员 84 人, 高级工程师 390 多人, 硕士研究生导师 35 人, 具有博士、硕士学位的科技人员 420 多人。

The 718th research institute of CSSC (PERIC) which belongs to China State Shipbuilding Corporation Limited was founded in 1966. It locates in Handan, Hebei Province, China. It is a state-level R&D institute which is mainly engaged in R&D design and manufacture, technical service, etc. There are more than 2,000 employees including 870 professionals. In the professionals, there are 30 people enjoy special government subsidies. There are 84 researchers, senior engineers 390, 35 Master Tutors, and there are 420 people with doctorate or master's degree.

#### 主要展品 /Products

中国船舶集团第七一八研究所主要业务范围包括: 特种气体产业, 空气净化产业, 精细化工产业, 氢能应用产业, 核电装备产业, 节能环保产业, 安防及仪器产业及特种装备产业。邯郸派瑞电器有限公司是中国船舶第七一八研究所发起成立的控股子公司, 依托七一八所在空气净化和检测专业上四十余年积累的研究成果、经验和专有技术, 主要从事空气健康、水健康、环境消杀与清洁系列产品的研发、生产和销售。

The 718th Research Institute of China Shipbuilding Group mainly covers special gas industry, air purification industry, fine chemical industry, hydrogen energy application industry, nuclear power equipment industry, energy conservation and environmental p

## Impower

安博尔

### 中山安铂尔电器有限公司

Zhongshan Anboer Electric Appliance Co., Ltd.

E2-2C66

地址: 广东省中山市小榄镇同茂村安铂尔电器有限公司 (328400)

Add: 39 wing Yip Street, Xiaolan, Zhongshan, Guangdong Province

电话 /Tel: 17197635888

传真 /Fax: 760-28158978

网址 /Web: http://www.impower.cn/

中山安铂尔电器有限公司位于广东中山。公司是一家集研发、生产、销售为一体的港资企业, 主营电水壶、养生壶、茶吧机等。公司研发团队 100 多人, 共申请专利 100 多项, 且拥有模具、五金、注塑等总装制造车间, 年生产能力超 1500 万台。产品取得了 GS/CE/CME/ROHS 认证, 已经与全球 45 个以

上的国家和地区合作, 并与众多知名品牌建立战略合作, 并以优良的品质, 独特的风格以及高效的服务深受客户的好评。

Zhongshan Ampel Electric Appliance Co., Ltd. is located in Zhongshan, Guangdong. The company is a Hong Kong funded enterprise that integrates research and development, production, and sales, mainly engaged in electric kettle, health care kettle, serving kettle, tea bar machine, and so on.

The company has a professional research and development team of over 100 people, has applied for more than 100 patents, and has assembly and manufacturing workshops for molds, hardware, and injection molding, with an annual production capacity of over 15 million units. The product has obtained the GS/CE/ME/ROHS certification, and has cooperated with enterprises in more than 45 countries and regions around the world. It has established strategic cooperation with many well-known brands. With excellent quality control, unique design style, and fast and efficient professional service, it is well received by foreign customers and world brands.

#### 主要展品 /Products

电水壶、养生壶、上水壶、咖啡壶、茶吧机、加湿器、电煮锅、多士炉等

Electric kettle, health pot, watering pot, coffee pot, tea bar machine, humidifier, electric cooker, toaster, etc

## AOWAYS

### 中山奥维斯电器有限公司

Zhongshan Always Appliance CO., LTD

N2-2A53

地址: 广东省中山市东凤镇同乐三路 48 号奥维斯电器 (528400)

电话 /Tel: 18680169681

网址 /Web: https://alwaysappliance.1688.com

中山奥维斯电器有限公司位于著名小家电产业广东省中山市, 公司主要生产绞肉机, 磨粉机, 榨汁机, 果汁机, 多士炉, 电热烧水杯等小家电产品。公司有专业的生产团队, 品质团队, 研发团队, 优质的售后服务团队。

公司以 OEM, ODM 为主, 产品远销欧洲, 美洲, 日韩, 东南亚国家。通过了 CCC, CE, ROHS, EMC, PSE, UL, ETL, FDA, REACH, UKCA, ERP, POPS 认证。产品深受国内外客户欢迎。

Zhongshan Always Appliance Co., Ltd. locates in the Zhongshan, Guangdong, which is the famous home of small home appliances. We specialize in the manufacturing of small appliances, spanning from Meat Grinder, Baby food Maker, Electric Coffee Grinder, Extractor Juicer, Slow Juicer, Juice Blender, Toaster, Electric Kettle, Milk Frother, Milk Shake Machine, Clothes Dryer. The company has professional production team, quality team, R&D team and high quality after-sales service team.

Our company mainly focuses on OEM and ODM. And our products are exported to Europe, America, Japan, Korea and Southeast Asia. We have passed CCC, CE, ROHS, EMC, PSE, UL, ETL, FDA, REACH, UKCA, ERP, POPS certifications. Our products are well received by customers at home and abroad.

#### 主要展品 /Products

绞肉机, 辅食机, 磨粉机, 果汁机, 榨汁机, 原汁机, 多士炉, 电热烧水杯, 奶泡机, 奶昔机, 干衣机  
Meat Grinder, Baby food Maker, Electric Coffee Grinder, Extractor Juicer, Slow Juicer, Juice Blender, Toaster, Electric Kettle, Milk Frother, Milk Shake Machine, Clothes Dryer



## GorFame

中山格福美电器有限公司

Zhongshan GorFame Electrical Appliance Co

E2-2A13

地址: 中山市小榄镇工业大道中 26 号之一二楼 C 卡中山市格福美电器有限公司 (528400)

Add: Unit C Floor 2 No.26-1 Middle Industrial Avenue Xiaolan Town Zhongshan City

Guangdong Province

电话 /Tel: 076022118680

传真 /Fax: 076022118680

中山市格福美电器有限公司创建于 2019 年,位于中山市小榄镇。本公司是一家专业的集设计、研发、生产、销售烤箱等厨房产品,生活家电企业。到目前为止业务遍布国内外市场,目前我们拥有 ISO9001 国际质量体系认证,中国 CQC 认证,欧盟共同体 GS、CE、ROHS、REACH、LFGB、ERP、澳洲 SAA 认证,韩国 KC 认证,美加 CETL、FDA 认证,ICE 体系的 CB 认证,中东 GCC 认证,BSCI 认证等。

Zhongshan GorFame Electrical Appliance Co., Ltd was founded in 2019, located in Xiaolan Town, Zhongshan City, We are built by a professional set of design, research and development, production, sales of oven and other kitchen products, household appliances enterprises, So far, our business has spread all over the domestic and foreign markets. I At present, we have ISO9001, CQC, EU COMMUNITY with GS, CE, ROHS, REACH, LFGB, ERP, Australia SAA certification, South Korea KC certification, THE United States and Canada CETL, FDA certification, CB of ICE system certification, the Middle East GCC certification, BSCI certification and so on.

### 主要展品 /Products

空气烤箱

air fryer oven

## 艾利普 AILIPU

中山市艾利普电器有限公司

ZHONGSHAN AILIPU ELECTRICAL APPLIANCE CO., LTD

N1-1B32 1B33 1B34

地址: 广东省中山市南头镇丰硕路 9 号 (528000)

Add: North of shenghui Industrial Nantou Town zhongshan City Guangdong Province china

电话 /Tel: 86-0760-22513626

传真 /Fax: 86-0760-22513669

网址 /Web: www.xunkon.com

中山市艾利普电器有限公司成立于 2008 年。公司坐落在中国小家电之都的南头镇,占地面积 10000 平方米,主要从事电磁炉、电压力锅、电饭煲、电陶炉、方煲、水壶等多种系列产品的开发销售及整机 OEM、ODM 制造的企业。公司具备强大的开发创新能力,国际先进的生产技术,制造设备,精密检测仪,科学化的管理及雄厚的生产能力。经多年的快速发展,已成为集专业研发、生产、销售家用电器为主导的大型现代企业。

Zhongshan Ai li pu Electrical Appliance Co.Ltd was established in 2008. It is a professional manufacturer specialized in high quality & stylish Induction Cooker, Infrared Cooker, Electric Kettle and Pressure Cooker. With the development of the company, we have our own brand "AILIPU". OEM and ODM are also welcomed. Our products are exported to south Asia, Middle East.

European, Africa North and South American and so on, and we also get high reputation from our customers. Looking forward to the future, we will continue to adhere to enterprise spirit to create top level products and best service for the world.

### 主要展品 /Products

生产、加工、销售电磁炉、电压力锅、电饭煲、方煲、电陶炉、电烤箱、电水壶、光波炉、家用电器、货物及技术出口

## BAIQIAO 柏侨

中山市柏侨电器实业有限公司

Zhongshan Baiqiao Electric Industrial Co., Ltd

N3-3B44

地址: 中山市小榄镇北区祥龙路 5 号 (528415)

Add: No. 5 Xianglong Road, North District, Xiaolan Town, Zhongshan, Guangdong, P.R. China

电话 /Tel: 0760-22557961

传真 /Fax: 0760-22557962

网址 /Web: http://www.zsbqkg.com

柏侨电器是一家专业研发制造家用电器开关、电器配件、塑料制品企业,引进了先进自动化生产设备、制造工艺技术,并配备高精度的检测设备,并建立符合安规标准的实验室。

本公司拥有高素质的技术研发队伍,满足不同顾客的产品需求。公司通过 ISO9001、ISO14001 管理体系认证,服务产品通过 CQC、CB、TUV、UL 等安规认证,广泛应用于:榨汁机、搅拌机、绞肉机、电烤箱、电煮锅等家电产品上。

Baiqiao Industrial is a professional R & D and manufacture of household electrical switches, electrical accessories, plastic products enterprise, with advanced automated production equipment, manufacturing technology and high-precision testing equipment. the company establish a laboratory in line with safety standards.

The company has a high quality technology research and development team to meet different clients needs. The company has passed ISO9001, ISO14001 management system certification, the product through CQC, CB, TUV, UL and other safety certification, widely used in: juicer, blender, meat grinder, electric oven, electric cooking pot and other household appliances.

### 主要展品 /Products

微动开关、旋转开关、琴键开关 (按键开关)、推档开关、翘板开关、拨动开关、跌倒开关等

Micro switch, rotary switch, key switch (key switch), push switch, rocker switch, toggle switch, fall switch, etc



BOANTAI

中山市博安泰电器科技有限公司

Zhongshan boantai electrics technology co., ltd

W5-5C65

地址: 广东省中山市南头镇同济西路 23 号宏基工业城 15 号楼 701 房 (528427)

Add: Room 701, Building 15, Acer Industrial City, No.23 Tongji West Road, Nantou Town, Zhongshan City, Guangdong Province

电话 /Tel: 13726085216

传真 / Fax: 0760-23110083  
网址 / Web: www.boantai.com

本公司主要研发、生产、销售温控器、压差开关、翻板开关、流量传感器等控制器，大功率温控行业首家实现全自动化生产，产销量均在行业前列，公司产品皆为自主创新设计，且拥有自主知识产权，目前发明专利 6 项，实用新型专利 28 项，秉着诚信为本、相互成长的经营理念，一切围绕解决客户痛点为原则，相互促进共同成长；聚焦大功率温控器，水流传感器，打造高质量、高性价比产品，欢迎各界朋友莅临指导。

Our company mainly develops, produces and sells controllers such as temperature controllers, differential pressure switches, flap switches, flow sensors, etc. It is the first in the high-power temperature control industry to realize fully automatic production, and its production and sales are in the forefront of the industry. Our products are all independently innovative designs, and we have independent intellectual property rights. At present, there are 6 invention patents and 28 utility model patents. We adhere to the business philosophy of honesty and mutual growth, and all focus on solving customers' pain points to promote mutual growth. Focus on high-power temperature controller and water flow sensor to create high-quality and cost-effective products. Welcome friends from all walks of life to visit and guide us.

#### 主要展品 / Products

温控器、水流量传感器、翻板开关、压差开关、风压开关等五金配件。  
Temperature controller, water flow sensor, flap switch, pressure difference switch, wind pressure switch and other hardware accessories.



#### 中山市博恩电器有限公司

N3-3B10

地址: 中山市东凤镇东阜三路 177 号 (528425)  
电话 / Tel: 0760873712  
传真 / Fax: 0760-87373310  
网址 / Web: https://cnzsbowen.en.alibaba.com/

公司座落于广东 - 中山 - 东凤, 规模达 500 余人, 拥有完善的管理体系。

从事咖啡机、厨师机、空气炸烤箱制造, 产品已通过 CCC、GS、CE、CB、ROHS、REACH、LFBG、ERP 等多项认证。公司已与国内外多个知名品牌达成 OEM/ODM 战略合作, 产品畅销国内及欧洲、美洲、台湾、香港、东南亚等国家和地区。

#### 主要展品 / Products

- 1, 咖啡机 (意式半自动一体研磨咖啡机, 美式咖啡机, 土耳其咖啡机)
- 2, 空气炸烤箱 (空气炸锅)
- 3, 厨师机 (和面机)
- 4, 果干机



#### 中山市德朗迪家用电器有限公司

N1-1A47

#### ZHONGSHAN DERANDI ELECTRIC APPLIANCE CO., LTD.

地址: 中山市南头镇光明北路 36 号厂房之三 (528403)  
Add: THREE OF FACTORY BUILDING NO.36, GUANGMING NORTH ROAD, NANTOU TOWN, ZHONGSHAN  
电话 / Tel: 3435421869  
网址 / Web: www.derandi.cn

我司从制造电压力锅和电饭煲配件起步, 距今已经有 15 年。厂区大概 2 万平方米, 有独立的注塑车间、冲压车间、配件组装车间、成品组装车间。目前我司的产品远销世界各国, 90% 为出口订单, 其中 80% 主要出口到美洲。

We started from a manufacturer of parts for pressure cooker and rice cooker for over 15 years. We have punching workshop, injection workshop, which we could control the quality from the parts then to the whole assembly.

As we got the experience from parts for pressure cooker and rice cooker, and we also have a partner who has great experience in pressure cooker for many years and from a famous company, basing on these we strated from doing whole set of pressure cooker. During these years, products were selling to Asia, Europe, US, Canada, and so on. Specially US, it's 80% of our main capacity.

#### 主要展品 / Products

我司主营多功能电压力锅、带自动排气电压力锅、空气炸电压力锅、空气烤箱、光波炉、空气炸锅, 另外还有专利产品即将上市。

We have multi-functional Electric pressure cooker, Auto release pressure cooker, Air fry pressure cooker, Air fry oven, Crispy lid, Air fry lid, and several patent products coming soon.



#### 中山市迪高诺电器科技发展有限公司

W5-5C86

地址: 广东省中山市南头镇晋合路 19 号 (528400)  
电话 / Tel: 1.39249374e+011  
传真 / Fax: 0760-23139698  
网址 / Web: www.chinatechno.cn

公司成立于 2007 年, ISO9001 国际质量体系认证企业。

为国内外多家知名品牌家电企业提供适用于空调、冰箱、厨具等家电产品的丝印、喷涂彩晶玻璃面板开发和生产配套服务。

产能 12000 片每天, 为确保满足客户的大量订单生产提供了保障。

家电产业的更高端、更深层次发展趋势, 激发了迪高诺人要全力以赴地配合知名家电企业缔造家电产品艺术价值的昂扬斗志, 为成为一流的家电企业协力供应伙伴而不遗余力!

#### 主要展品 / Products

家电玻璃 玻璃制品  
GLAS



### 中山市乖致电器科技有限公司

#### Zhongshan City Guaizhi Electrical Technology Co., Ltd

地址: 广东省中山市东凤镇和泰村兴华东路 82 号首层之一 (528400)

电话 /Tel: 0760-89766088

邮箱 /E-mail: 647153045@qq.com

网址 /Web: http://guaizhi.en.alibaba.com

中山市乖致电器科技有限公司成立于 2017 年, 厂房占地面积三千 平方米, 员工人数 51-100 人左右, 是一家专业做破壁机的中小型生活 小家电的公司。中山市乖致电器科技有限公司是破壁机、豆浆机、果汁机等产品专业生产加工的公司, 拥有完整、科学的质量管理体系, 通过 ISO-9001:2015 质量认证体系。公司的诚信、实力和产品质量 均获得业界的认可, 欢迎各界朋友的莅临参观、指导和业务洽谈。

Founded in 2017, Zhongshan City Guaizhi Electrical Technology Co.,Ltd. covers an area of 3,000 square meters and employs 51-100 people. The company is a small and medium-sized small household appliance company specializing in wall breaking machines. Our company specializes in the production of broken wall machines, high speed blender with heating, portable blender with charging and so on. We have integrated, scientific management system to insure our high quality product. We devote to using modern production workshop, advance equipment, exquisite technology. From raw material procurement to production, quality inspection has a perfect management system.

The company's cooperation customers include Whirlpool, Konka, Royalstar, Vatti, Amoi, Blaupunkt, Gome, Skyworth, Deslon, Hongla, Longde, etc. The company mainly serves shopping malls, manufacturers and individuals, etc, and can process supplied materials, OEM processing, ODM processing, etc.

#### 主要展品 /Products

破壁料理机, 便携式果汁杯, 无线绞肉机, 多功能料理棒, 多功能料理锅, 多功能料理机, 冰箱除味器, 消毒刀架

Sterilization knife holder, Ozone negative ion fresh-keeping box, Portable multifunctional cooking pot, Wireless cooking meat grinder, Multifunctional shredder, Mini soy Mike Maker, Multi-function cooking machine

Multi-function cooking stick, Portable electric juice machine, Portable electric juice machine, Multifunctional broken wall cooking machine, Ultra-thin broken wall cooking machine

### GUIBAO 贵宝

### 中山市贵宝电器有限公司

#### ZHONGSHAN GUIBAO ELECTRICAL APPLIANCE CO., LTD

地址: 中山市南头镇升辉北工业区升平北路 21 号 (528427)

Add: NO.21, NORTH SHENGPING ROAD, SHENGHUI INDUSTRIAL AREA, NANTOU, ZHONGSHAN CITY, GUANGDONG PROVINCE, CHINA

电话 /Tel: 0760-22616906

传真 /Fax: 0760-22616937

网址 /Web: www.gd-guibao.en.alibaba.com

中山市贵宝电器有限公司电器创建于 1995 年, 坐落在中山市南头镇的一家专业生产小家电的企业。公司专业生产 water boiler, coffee maker, coffee grinder, kettle, tea maker 等产品。“贵宝”是中

国不锈钢电热水瓶, 电热水桶最大的出口企业, 产品远销世界各地。我们出口的国家主要有欧洲, 德国, 英国, 南非, 澳大利亚, 中东, 南美, 韩国, 俄罗斯等国家。

ZHONGSHAN "GUIBAO" ELECTRICAL APPLIANCE CO., Ltd is a leading manufacture & supplier of electric home appliances, such as electric water boilers, coffee urns, tean makers and kettles. GUIBAO has over 20 years of experience in the industry and our products are distributed domestically and internationally. To meet customer demand and specification, our products pass UL, GS, CE, CB, LFGB, REACH, RoHs and various other testing to conform to your country's standard. We have a complete system of product design and development (R&D), production and sales.

#### 主要展品 /Products

电热水桶, 咖啡机, 快速电热壶, 俄罗斯茶壶  
water boiler, coffee boiler, kettle, tea maker, samovar

### Haiyu 海瑜®

### 中山市海瑜生活电器有限公司

#### Zhongshan Haiyu Electrical Appliance Co., Ltd.

地址: 广东省中山市阜沙镇阜港西路 (528434)

电话 /Tel: 86-0760-22796938

传真 /Fax: 86-0760-23400499

网址 /Web: www.hysgdq.com

我司成立于 2009 年, 集研发、生产和销售为一体的以电饭煲、电压力煲为主的较大民营企业; 我司位于中国经济最活跃的珠三角区域腹地—中山市阜沙镇, 公司注册资本 3000 万元, 占地面积 2 万多平方米, 建筑面积 5 多万平方米, 公司现有员工约 500 人, 年销售规模约 3 亿元, 公司有一支从业经验丰富、创新的技术研发团队, 品质过硬的生产团队, 凭借良好的产品和品牌形象, 专业的技术及诚信的服务宗旨, 深受广大消费者喜爱。

#### 主要展品 /Products

电压力锅、电饭煲

### SUKIO 硕高

### 中山市合硕高品电器有限公司

#### Zhongshan SUKIO Electric Appliance CO., Ltd

地址: 广东省中山市南头镇建安路 1 号 (528427)

电话 /Tel: 86-0760-22609802

传真 /Fax: 86-0760-22609801

网址 /Web: www.sukio.net

本公司成立于 2010 年, 位于珠三角黄金腹地—中山市南头镇, 是一家集 (研发、生产、销售、服务) 于一体的电磁加热技术制造型企业。

公司产品主要涉及出口、OEM、ODM、国内销售。核心配件自主研发生产, 研发团队能力超强。同类产品连续多年居全国市场销售量、销售额、市场占有率前列。同时与国内知名品牌保持着友好的战略合作关系, 并得到客户对产品质量、款式一致认可的好口碑。

#### Company Profile

SUKIO is a professional manufacturer specializing in INDUCTION COOKER and CERAMIC



COOKER which located in Nantou Town, Zhongshan City of China.  
INDUCTION COOKER included Portable Cooker, Built-in Cooker, Mixed Cookers, Commercial cooker

CERAMIC COOKER included Portable Cooker, Built-in Cooker and Mixed Cooktop.

ADVANTAGES of SUKIO

- 1, Cover an area of 10000 m<sup>2</sup> and 280 employees
- 2, Key components produced by 4 workshops such as heating coil/Al/SMT/PCB
- 3, 4 assembling lines which can reach 18K per month
- 4, 10 experienced engineers devote themselves to outer shaped/PCB/procedure etc
- 5, 18 experienced QCs devote themselves to control all concerned quality during whole steps
- 6, Labs included EMC/safety/RoHS/aging/noise/energy saving etc to support models we have
- 7, ISO system takes care of quality, 10004 system takes care of workshop environment and BSCI takes care of employees
- 8, Most of models have CCC/CB/CE, few models have ETL/SAA/GCC/RoHS approvals

#### 主要展品 /Products

电磁炉, 电陶炉, 混合炉, 商用炉  
induction cooker  
ceramic cooker  
commercial induction cooker  
induction and ceramic mix cooker



宏禾玻璃科技

#### 中山市宏禾玻璃科技有限公司 Zhongshan Honghe Glass Technology Co., Ltd

N2-2B01

地址: 广东省中山市小榄镇富民大道3号 (528400)

电话 /Tel: 0760-22222170

传真 /Fax: 0760-22222173

网址 /Web: www.hongheglass.net

我司成立于2007年9月1日, 主要生产彩晶玻璃、3D玻璃、曲面异形钢化玻璃、热水器面板、烟机灶具、空调面板、空气净化器家用电器玻璃。公司拥有多台大型平弯炉、异型钢化炉、热弯炉、钻孔机、水切割机、高精度CNC磨边机、丝印机等完整的先进生产设备。有丰富经验和成熟的技术, 完善的品质要求及ISO9001-2016质量认证和RoHS保证体系。能为客户提供高标准高质量的产品。

#### 主要展品 /Products

彩晶玻璃、3D玻璃、曲面异形钢化玻璃、热水器面板、烟机灶具、空调面板、空气净化器家用电器玻璃

## ONEKING

### 中山市胡博士电器科技有限公司

W3-3C114

地址: 广东省中山市东凤镇东海西路98号A栋3楼

电话 /Tel: 15016191761

传真 /Fax: 0760-22782728

中山市胡博士电器科技有限公司于2016年01月29日成立, 法定代表人胡彩添, 公司经营范围包括: 研发、设计、生产、销售家用电器、配件及电子产品, 公司自成立以来, 始终坚持以人才为本, 诚信立业的经营理念, 为企业供给全方位的解决方案, 帮忙企业提高管理水平和生产本事, 使企业在激烈的市场竞争中始终坚持竞争力, 实现业快速、稳定地发展。

#### 主要展品 /Products

公司经营范围包括: 研发、设计、生产、销售家用电器、配件及电子产品。



### 中山市华尼斯电子有限公司

W2-2B41

#### Zhongshan Huanisi Electronic co., Ltd

地址: 广东省中山市东升镇东成路29号 (528414)

Add: No.29 Dongcheng Road, Dongsheng Town, Zhongshan City, Guangdong province, China

电话 /Tel: 0760-85408282

传真 /Fax: 076085408976

网址 /Web: www.huanisi 2009.1688.com

我司专业生产硅胶发热线、加热带、各种发热膜等, 广泛应用于电饭煲、毛巾柜、电暖桌、抽油烟机、冷柜冷库除霜线、曲轴加热带、取暖器、暖手宝等。我司拥有完整、科学的质量管理体系。与业内多家知名生产企业长期合作, 以诚信、实力和产品质量获得业界的认可。我公司可以定做各种型号加热线、发热组件等, 产品质优价廉, 交期准确。

欢迎各界朋友莅临中山市华尼斯电子有限公司参观、指导和业务洽谈。

#### 主要展品 /Products

硅胶发热线、铝箔加热带、曲轴加热带、门框防水型硅胶加热带、冷库排水管化霜加热线、风机盘管化冻加热线、电饭煲加热线、毛巾柜发热膜等



### 中山市华塑塑胶科技有限公司

W4-4A30

#### Zhongshan Huasu Plastics Technology Co., Ltd

地址: 广东省中山市东升镇兆益路69号 (528414)

Add: No.69, ZhaoYi Road, DongSheng Town, Zhongshan City, GuangDong Province, China

电话 /Tel: 0760-22225800

传真 /Fax: 0760-22826297

网址 /Web: www.huasu888.com

华塑科技成立于 2005 年,专业从事工程塑料、改性塑料、复合塑料的新材料研发生产销售,公司是国家高新技术企业,通过了 ISO9000 国际质量认证和 ISO16949 汽车认证,拥有 20 条双螺杆挤出生产线,年产量为 50000 吨。设有精密的塑料检测中心,检测仪器齐全,具有一套完备的工程塑料物性检测体系。经营 PA6、PA66、PP 等塑料增强、增韧,阻燃、高光泽、高抗冲及耐候,公司产品性能稳定并远销全球多个国家。

Huasuo Plastics Technology Co.,Ltd. founded in 2005, is a professional high-tech enterprise in engineering plastics, modified plastics, composite plastics and new plastics. We have gained the quality management system certification ISO 9000 and automotive certification ISO16949. HUASU have twenty twin screw production lines with annual output of 50,000 tons. We have a precise plastic testing center with complete testing equipment and a complete set of testing system for engineering plastics physical properties. HUASU mainly manufacturing all kinds of engineering modified plastics, such as PA6, PA66, PP plastic plus reinforced, toughness, flame retardant, high glossiness, high impact resistance and weather resistance performance. Our products are mainly used in automotive, train, household appliances, electronic appliances, furniture and so on. We have exported to many countries for the stable quality. We are willing to provide the best service for all of you.

#### 主要展品 /Products

经营 PA6、PA66、PP 等塑料增强、增韧,阻燃、高光泽、高抗冲及耐候,主要应用汽车,火车,家电,电子电器,家具等产品

PA6, PA66, PP plastic plus reinforced, toughness, flame retardant, high glossiness, high impact resistance and weather resistance performance. Our products are mainly used in automotive, train, household appliances, electronic appliances, furniture and so on.



#### 中山市华尊电机有限公司

**N2-2B51**

地址: 中山市南头镇盈穗路七号三栋 (528400)  
电话 /Tel: 0760-22608826

中山市华尊电机有限公司成立于 2015 年,是一家集研发、设计、生产、销售于一体的高新技术企业,拥有独立的电机和五金冲压车间,专业生产交直流贯流风机、高温电机及减速箱电机等通风加热电机产品。

公司开展业务至今,已经具备相当成熟的电机业务,产品广泛应用于电烤炉、电壁炉、电烤箱、雾化器、中央空调、电动晾衣机、空气炸锅、风幕机、空气净化器家电及商用电器产品。

#### 主要展品 /Products

直流贯流风机、高温电机及减速箱电机等通风加热电机产品

## HUIDE®

### 中山市汇德温控器有限公司 Zhongshan Huide Thermostat Co., Ltd.

**W2-2A23 2A24**

地址: 中山市横栏镇永谊一路 9 号 (528478)  
Add: No. 9, Yongyi 1st Road, Henglan Town, Zhongshan City  
电话 /Tel: 13923302335  
传真 /Fax: 0760-87616599  
网址 /Web: <http://www.huidewk.com>

本公司是一家专业集设计开发、生产经营、产品销售为一体的国家高新技术企业。公司温控器、档位开关、倾倒开关、开关产品种类齐全,公司技术力量资源丰富专业技术人员和主干管理人员有近 30 人,其中温控器行业经验超过十年以上有 8 人,拥有生产员工 260 人,公司总面积 10000 平方米,下属五金部,技术部,品管部,生产部,自动化设备部,工艺部,仓库等重要部门。公司配套设施齐全,产品质量稳定。

The company is a national high-tech enterprise specializing in design and development, production and operation and product sales. The company has a complete range of thermostat, gear switch, dump switch and switch products. The company has rich technical force and resources. There are nearly 30 professional technicians and backbone managers, including 8 with more than 10 years of experience in the thermostat industry and 260 production employees. The company has a total area of 10000 square meters, subordinate Hardware Department, technology department, quality control department, production department and automation equipment department, Process department, warehouse and other important departments. The company has complete supporting facilities and stable product quality.

#### 主要展品 /Products

公司主要生产温控器、档位开关、倾倒开关、开关产品种类齐全,产品广泛应用于电烤箱、电暖器、烤炉、烤盘、煮水炉、多士炉、油炸锅、电暖灯、电熨斗、电饭煲、机(箱)柜等家电产品。公司产品均通过欧美国家和国内产品安规认证以及环保测试要求。

The company mainly produces temperature controllers, gear switches, dump switches and switches, with a complete range of products. The products are widely used in electric ovens, electric heaters, ovens, baking pans, water cookers, toasters, fryers, electric heating lamps, electric irons, rice cookers, machine (box) cabinets and other household electrical appliances. The company's products have passed the product safety certification and environmental protection test requirements of European and American countries and domestic products.



### 中山市汇贤智控科技有限公司

**W3-3A25**

地址: 广东省中山市横栏镇永兴北路 2 号 3 楼 (528400)  
电话 /Tel: 0760-23377286  
传真 /Fax: 0760-23377287  
网址 /Web: [www.hs-pcba.com](http://www.hs-pcba.com)

中山市汇贤智控科技有限公司成立于 2017 年是一家专业从事家用电器控制器研发、制造和销售的新型高新技术企业。产品包括制冷、制热类小家电以及 wifi、蓝牙、2.4G 等智能化电控板。公司拥有一支技术水平领先、创新能力强的运营团队,以高品质、合理价格、快速反应,为客户提供服务。公司现有配套年产值 5000 万规模,拥有现代化生产设备和绿色环保电子制造设备,封闭,无尘 ESD 的高标准空调厂房。

Zhongshan Hui Shine PCBA Co., Ltd. is a new high-tech enterprise specializing in R & D, manufacture and sale of household electrical appliances controller. Products include kitchen appliances, electric fireplace, water purification equipment, environmental appliances, as well as Wi-Fi, Bluetooth, 2.4G and other wireless internet intelligent electronic control panels. The electronic control board is the core component of the household appliance products. We provide the core technical support and value-added service for our customers, which greatly reduces the customer's risk in technology, management and decision-making. The company has a high technical level leading, innovative and efficient operation team, through the team's sincere cooperation, with high quality, reasonable price, quick response, to provide value-added services for customers.

#### 主要展品 /Products

环境电器 (制热、制冷类小家电电路板)、电动工具电路板。



### 中山市洁鼎过滤制品有限公司 J&D Activated Carbon Filter Co., Ltd.

W5-5B13

地址: 广东省中山市火炬开发区十涌路 13 号之一 B 幢、C 幢 (528437)

Add: N0.13 Shiyong road, Torch Hi-tech Development Zone, Zhongshan city,

Guangdong 528437, China

电话 /Tel: 86-0760-85283318-303

传真 /Fax: 86-0760-85330076

网址 /Web: www.cleantop.com.cn

洁鼎, 成立于 2002 年, 是一家专业的环保过滤制品生产企业。公司专注于空气过滤和水过滤产品的研发和制造, 现形成了 6 大系列产品: HEPA 过滤网、除甲醛过滤网、活性炭过滤网、除臭氧过滤网、抽油烟机过滤网和滤水芯。

公司通过了 SGS 的 ISO9001:2015 和 ISO14001:2015 质量环境管理体系认证。

质量第一、顾客至上、诚信为本。洁鼎愿为每位客户提供最优质、全面、专业的服务。

J&D, a professional manufacturer of environment-friendly filtration products, is located at N0.13 Shiyong road, Torch High-Tech Development Zone of Zhongshan City, covering a manufacturing area of about 50,000 square meters.

Established in 2002 and specialized in R&D and manufacturing of air-filtering and water-filtering products, we have formed six main product lines, including HEPA filters, formaldehyde removal filters, activated carbon filters, Ozone removal filters, range hood filters and water filters. Since 2002 till now, we have obtained more than 30 patents by independent research, development and innovation. Four of them are invention patents.

We gained both ISO 9001:2015 International Quality Certificate and ISO 14001:2015 International Environmental Certificate certified by SGS.

Quality First, Customer First and Good Faith. We wish to provide high quality products, professional and all-around services to each customer.

#### 主要展品 /Products

HEPA 过滤网, 活性炭过滤网, 除甲醛过滤网, 抽油烟机过滤网, 除臭氧过滤网, 净水滤芯, 车用空调滤芯, 新风机初效滤芯等系列产品

HEPA filters, activated carbon filters, formaldehyde removal filters, range hood filters, Ozone removal filters, water filters, Cabin filter for Car and Pre-filter for HVAC system



### 中山市金稻电器有限公司 Zhongshan Kingdom Electrical Co., Ltd

E3-3C41

地址: 广东省中山市三乡镇平南工业区金宏路 32 号

Add: NO.32, Jinhong Road, Pingnan Industrial Area, Sanxiang, Zhongshan, Guangdong, China

电话 /Tel: 076087198619

网址 /Web: www.kingdomcares.com

金稻公司成立于 1999 年, 22 年专注一个行业, 把美容院搬回家, 集研发、销售、生产、品牌于一体, 其研发与销售是金稻的核心, 公司拥有 100 多项专利。产品出口美国、日本、欧洲、东南亚等多个国家, 前十四年以出口为主, 近六年以自主品牌“K:SKIN 金稻”为主, 金稻已经是女性个人护理行业的翘楚。如今行业领先品牌, 3.5 万平方米的欧式厂区, 无尘车间精益生产, 顶尖的研发团队, 强大的销售渠。

Founded in 1999, K:SKIN Company focused on one industry for 22 years, bringing the beauty device at home. The products involved 12 categories, such as hair straightener & curler, facial steamer, massage, cleansing, oral care, healthcare, etc. Integrating R&D, sales, production, and brand, which R&D and sales are the core of K:SKIN. The company has more than 100 patents, 70% of product sales are indomestic, and 30% are in exports. E-commerce channel sales are mainly used at home and abroad. The products are exported to the United States, Japan, Europe, Southeast Asia and other countries. The first fourteen years were mainly exported, and in the past six years, it has been dominated by its own brand "K:SKIN". K:SKIN is already a leader in female personal care industry.

#### 主要展品 /Products

金稻产品包含 12 个大类, 200 多款产品, 如直卷发类、蒸脸器类、按摩类、洁面类、口腔护理类、保健类等, 集研发、销售、生产、品牌于一体, 其研发与销售是金稻的核心, 公司拥有 100 多项专利。

The products involved 12 categories, such as hair straightener & curler, facial steamer, massage, cleansing, oral care, healthcare, etc. Integrating R&D, sales, production, and brand, which R&D and sales are the core of K:SKIN. The company has more than 100 patents.

### 中山市君拓电器有限公司

E2-2B12

地址: 中山市东凤镇东和平村东阜四路 57 号东来大厦 A 幢四楼之一 (申报住所) (528420)

电话 /Tel: 0760-89997390

传真 /Fax: 0760-89997391

中山市君拓电器有限公司: 成立 2020 年 12 月 22 日, 注册资本 100 万元, 经营范围: 家用电器研发: 家用电器销售: 家用电器制造: 电子产品销售: 家用电器零配件销售: 厨具卫及日用杂品批发: 电器辅件制造: 电器辅件销售: 其他电子器件制造: 电子元件制造: 电子元件批发: 日用家电零售: 五金产品制造: 五金产品批发: 塑料制品销售。

#### 主要展品 /Products

多功能电蒸锅, 电火锅, 隔水炖盅

**candor 凯得®**

世界品质的高端制冷

**中山市凯腾电器有限公司****N2-2B56**

地址: 广东省中山市南镇兴业北路 41 号

电话 /Tel: 076023978335

网址 /Web: <https://www.gdcandor.com/>

凯腾电器成立于 2004 年 12 月, 始建于中山市黄圃镇大雁工业区, 是目前国内最主要的红酒柜供应商之一, 是中国最早研究半导体制冷技术的企业。经过多年的发展, 迄今已成长为一项专业研发、生产半导体冰箱和压缩机红酒柜的国家级高新技术企业。

**主要展品 /Products**

嵌入式冰箱, 红酒柜

**中山市康拉德电器有限公司****N3-3B19**

地址: 广东省中山市南头镇富民路 8 号

电话 /Tel: 13928286160

中山市康拉德电器有限公司是位于广东地区一家集研究, 开发, 设计以及生产为一体的小家电 OEM/ODM 制造商, 具体位于中国广东中山市, 自 2006 年起已经开始专业专注于小家电行业。目前拥有 8000 m<sup>2</sup> 厂房, 并有员工 150 多人和多位专业技术和品质工程师。

公司主要产品包括空气炸锅, 空气烤箱, 电烤炉等。我们所有的产品符合国际质量标准, 出口到北美, 南美, 亚洲和欧洲等市场。

**主要展品 /Products**

空气炸锅, 空气烤箱, 电烤炉

**中山市快美特电器有限公司****N2-2A16****KUAI MEI TE**

地址: 广东省中山市东凤镇安乐村创源路 103 还二楼

电话 /Tel: 18689315728

公司成立于 2014 年, 位于广东中山, 是一家集技术研发、生产、销售于一体的综合型企业; 专业生产破壁机、豆浆机、空气炸锅、多功能电锅等产品。公司成立至今, 拥有 40 多条装配生产流水线, 200 余项专利, 厂房综合面积 6 万平方米, 年产量超 800 万台, 年产值 8 亿元。公司不断配备先进的生产设备和现代化的检测设备; 组建专业的研发管理团队, 产品通过国家 CCC 和 CQC 强制认证并获得 CE, CB, ETL, KC 等多项国际认证

**主要展品 /Products**

破壁机 // 豆浆机 // 果汁机 // 料理机 // 空气炸锅 // 电火锅

**KUTO 快特****中山市快特电器有限公司****N3-3A43 3A44****ZhongShan Kuaite Electrical Co., Ltd.**

地址: 广东省中山市东凤镇玉峰路 68 号快特电器 (528425)

Add: Building 1, No.68 Yufeng Road, Tongle Industrial Park, Dongfeng Town, Zhongshan City, Guangdong Province, China

电话 /Tel: 13925364455

传真 /Fax: 0760-22776369

中山市快特电器有限公司成立于 2011 年, 是一家长期致力于专业破壁料理机系列高端健康生活电器产品、并集设计研发、生产制造、销售服务为一体的综合型专业精工制造企业。目前公司拥有国内行业内独家现代化生产无尘车间, 专业化的产品实验检测中心、卓越的管理 +EMC 体系、专业化的工程技术人才。公司产品通过 CCC、CE、CB、GS、ETL、EMC 以及产品食品卫生 (FDA、LFGB 等) 强制性安全认证。

KUTO specializing in researching, developing and manufacturing innovation Power blender, Soup blender, Slow juicer since 2011, and establish injection factory since 2015.

Production facilities are completed including mold factory design department, laboratory, injection factory, assembling workshop (10 production lines) 3.2 millions pcs of production capacity per year.

Most of our products approved with CB /CE/EMC/LVD, ERP, ROHS/ LFGB/ ETL/UL/FDA/SASO to meet customers demand all over the world, as an ISO9001 certified company, we will keep top quality, competitive price, on-time delivery, professional service for customers needs.

We also provide an extensive range of customized services in order to cater for clients special orders to help customers realize their goals we are making efforts to achieve this win-win situation and sincerely welcome you join us.

**主要展品 /Products**

我司主营产品为破壁机、电饭煲、原汁机、蒸锅、刀架、电动电热类产品。

Our main products for broken wall machine, rice cookers, juice machine, steamer, knife frame, electric heating products.

**LEPTIS 莱普帝斯****中山市莱普帝斯电器有限公司****N3-3D81****Zhongshan leptus Electric Appliance Co., Ltd**

地址: 广东省中山市南头镇永辉路 23 号

电话 /Tel: 18575855699

公司是一家集研发、生产、销售为一体的专门从事吸油烟机、集成灶具、蒸烤箱、微蒸烤箱、净水器等厨具产品专业化制造企业, 是众多知名品牌 OEM/ODM 厨具代工制造商。公司通过 ISO9001: 2008 认证, 雄厚的产品技术开发力量, 使得所开发上市的产品已有 100 多种, 在质量管理上, 严格执行国际 ISO9001: 2008 标准。多项产品技术、多项实用新型专利

**主要展品 /Products**

吸油烟机、集成灶具、蒸烤箱、微蒸烤箱、净水器等厨具产品



ILVSD®

利维·斯顿

中山市朗田电器有限公司

ZHONGSHAN LONTAN ELECTRICAL INDUSTRY CO., LTD

E2-2H76

地址: 广东省中山市东凤镇东海五路永益工业区 (528425)

电话 /Tel: 4008823396

传真 /Fax: 0760-22635656

网址 /Web: www.ilvzd.com

ILVSD (利维斯顿) 在德国 Hamburg 自创立初始就秉承并一直在坚持做一件事, 为用户创造一个安全、健康、舒适的居家生活环境。经多年发展成为健康家电领域的专业品牌, 凭借极具优势的健康家电产品迅速赢得了市场的一致好评, 确立了在国际、国内市场上高阶产品品牌形象和地位。

ILVSD (Leviston) in Hamburg, Germany since its inception has been adhering to and has been insisting on one thing, to create a safe, healthy and comfortable home living environment for users. After years of development to become a professional brand in the field of health home appliances, with a very advantageous health home appliances products quickly won the market consensus, established in the international and domestic market brand image and status of high-end products.

## 主要展品 /Products

取暖器、空气循环扇、加湿器

Heaters, air circulation fans, humidifiers



中山市乐喜电子科技有限公司

N1-1D71

地址: 广东省中山市西区昌观路 48 号

电话 /Tel: 0760-87954455

中山市乐喜电子科技有限公司成立于 2017 年 4 月, 专注于研究无感智能卫浴空间场景下用户体验的整体智能化解决方案, 通过利用多种类型的智能化技术, 整合出符合人性化的人机交互智能界面, 为用户个性化定制出舒适便捷、健康环保的智能卫浴场景。

## 主要展品 /Products

智能零冷水控温花洒、智能零冷水感应龙头、智能零冷水套装

neon®

中山市力泰电子工业有限公司

W3-3B08

Zhong Shan City Li Tai Electronic Industrial Co., Ltd

地址: 广东省中山市五桂山镇第三工业区 (528458)

Add: No.3 Industrial district, Wuguishan Town, Zhongshan City, Guangdong Province, China

电话 /Tel: 0760-23808633

传真 /Fax: 0760-23808800

网址 /Web: www.neon.com.cn

中山市力泰电子工业有限公司成立于 1995 年, 是一家以技术创新、科技研发为导向的专业从事迷你家庭影院产品研发、生产、销售的中外合资企业。公司自成立伊始, 便确立科技创新为导向的发展方针, 建立有职能完备的企业技术中心。是一家广受同业及外界人士信赖的企业。主要生产高素质音频产品, 包括有 CD 迷你组合音响、电子管胆机、复古蓝牙音响等产品。

Zhong Shan City Li Tai Electronic Industrial Co., Ltd is a joint venture company specializing in developing and manufacturing high-end audio products and smart home products, such as micro Hi-Fi system, retro CD player, Bluetooth speaker and smart toilet seat. Since its founding in 1995, the company has been committed to deliver the best in sound reproduction by traditional craftsmanship and latest technology for its own brand NEON and partners like Philips, Hitachi, Grundig, JVC, etc.

## 主要展品 /Products

音响

Bluetooth speaker, Micro Hi-Fi system, Valve Hi-Fi system



中山市连想电器有限公司

W3-3H99

ZHONGSHAN LIANXIANG ELECTRICAL APPLIANCE CO., LTD

地址: 广东省中山市东凤镇永益村东海六路 52 号二楼 (528425)

Add: 2nd Floor No.52 Donghai Six Road, Yongyi Village, Dongfeng Town, Zhongshan City, Guangdong China.

电话 /Tel: 13925329300

传真 /Fax: 0760-22636620

网址 /Web: https://zslianxiang.com

中山市连想电器有限公司是一家专业从事加湿器产品开发、生产、销售、服务一体的公司, 拥有完整、科学的质量管理体系, 产品均取得 CB, CE, ROHS, PSE 等认证, 销往国内外等多国家和地区, 并为国内外品牌提供 OEM 生产, 深受广大客人和消费者的青睐, 欢迎国内外客商与我们建立良好的业务合作关系。

Zhongshan Lianxiang Electric Appliance Co., Ltd. is a manufacturer specializing in the development, production, sales and service of humidifier products. We owned a complete and scientific quality management system. Products have obtained CB, CE, RoHS, PSE and other certification, sell to many countries and regions at domestic and foreign market. We provides OEM production for domestic and foreign products which is deeply favored by customers and consumers. Welcome to establish good business relations with us, we have always been here and look forward to your joining.

## 主要展品 /Products

加湿器, 电暖器,

Air Humidifier, Electric Heater

曼诺施电器  
MANSHEI ELECTRIC APPLIANCE**中山市曼诺施电器有限公司****W3-3C110 3C111**地址: 广东省中山市东凤镇东凤大道南 333 号  
电话 /Tel: 18824962291

中山市曼诺施电器有限公司坐落于小家电“基地”广东省中山市东凤镇。是一家以小家电为主,集研发、生产、经营为一体的企业实体。

公司生产产品主要包括加湿器、消毒机、除螨仪、取暖器、风扇、果蔬机等,公司始终坚持品质把控贯穿始终,从“研发-生产-销售-物流-售后服务”全程严格把关。并以诚信、实力和产品质量获得业界的认可。

**主要展品 /Products**

除螨仪、果蔬消毒机、空气净化消毒机、超声波加湿器、冰箱除味器

**中山市南歌电子制造有限公司****W3-3D118****Zhongshan Nange Electronic Manufacturing Co., LTD**

地址: 广东省中山市东凤镇伯公社区恒昌街 20 号

Add: No.20, Hengchang Street, Bogong Community, Dongfeng Town, Zhongshan City, Guangdong Province

电话 /Tel: 0760-22626699

网址 /Web: <https://shop1415983253496.1688.com/>

中山市南歌电子制造有限公司成立于 2003 年,注册资金 202 万,员工 300 余人,是广东省中山市一家专业做母婴小家电的公司。公司的产品主要是调奶器,暖奶器,摇奶器、恒温碗、奶瓶消毒器,紫外线衣物消毒烘干机等。

Zhongshan Nange Electronic Manufacturing Co., Ltd. was established in 2003, with a registered capital of 2.02 million yuan and more than 300 employees. It is a company specializing in making small household appliances for mothers and babies in Zhongshan, Guangdong Province. The company's products are mainly milk mixer, milk warmer, milk shaker, constant temperature bowl, bottle sterilizer, UV clothing disinfection dryer, etc.

**主要展品 /Products**

恒温调奶器,定量出水奶机,紫外线消毒烘干柜,滚筒式烘干机,蒸汽奶瓶消毒器,暖奶器。

Thermostatic milk mixer, quantitative blister milk machine, UV disinfection drying cabinet, tumble dryer, steam bottle sterilizer, milk warmer.

**中山市尼克智能科技有限公司****N3-3A42****Zhongshan Nick Smart Technology Limited**地址: 广东省中山市东凤镇东平村东河西路一街 22 号  
电话 /Tel: 15819335736

中山市尼克智能科技有限公司位于广东省中山市东凤镇,是以养身搅拌机、迷你豆浆机以及电热水壶等小家电为主的专业产品生产加工的公司,拥有先进、科学的质量管理体系。公司产品远销海内外,销售多元化,与时俱进,深受广大群众的欢迎与喜爱。广东省中山市尼克智能科技有限公司的诚信、实力和产品质量获得业界的认可。欢迎各界朋友莅临参观、指导和业务洽谈。

**主要展品 /Products**

养身搅拌机,迷你豆浆机,电热水杯,电热水壶

**中山市欧博尔电器有限公司****N3-3F06****Zhongshan Aouball Electric Appliances Co.Ltd.**

地址: 中山市南头镇万瑞街 1 号 (528427)

Add: No.1, Wanrui street, Nantou town, Zhongshan city, Guangdong, China

电话 /Tel: 13823492924

传真 /Fax: 0760-23115286

网址 /Web: <https://aouball.cn>

中山市欧博尔电器有限公司位于广东省中山南头镇,20 条生产线 800 多人,月标准产能 15 万台以上,配备了模具制作部,注塑部,新技术研发中心,品质检测中心等完备设施。公司荟萃一批顶尖开发工程师及品管工程师,具备自主设计、自主创新、自主制作的巨大研发生产能力,以其独特的加工工艺作为权威产品品质的有力保障,科学的生产流程规范着每一位员工的操作。严谨的工作态度,规范的管理铸就了高质量的保证。

Zhongshan Aouball Electric appliances Co., Ltd, founded in 2010, is located in Nantou Town, Zhongshan City, Aouball owns an R&D high tech center with more than 30 professional and experienced engineers in kitchen appliances, with more than 60 utility model patents, 16 invention patents, hundreds of product design patents and many major domestic design awards. Aouball Electrical Technology Park covers 60000 m<sup>2</sup> with assembly workshop of 20 intelligent production lines, auto injection molding workshop, metal stamping workshop, and a comprehensive testing center that meets GS and UL standards to ensure product quality for customer needs. For 10 years, Aouball has been dedicated in R&D, production and sales on small western kitchen appliances such as air fryer, steam oven, meat grinder, slow juicer, coffee machine etc.

**主要展品 /Products**

空气炸锅,绞肉机,原汁机,咖啡机等

Air Fryer Oven, Meat Grinder, Slow Juicer, Espresso Machine

# olayks.

中山市欧莱克电器有限公司

E2-2H21

Zhongshan oulaike electrics co., ltd

地址: 广东省中山市黄圃镇健成路 26 号 (528429)

Add: No.26 Jiancheng Road, Huangpu Town, Zhongshan City, Guangdong Province

电话 /Tel: 13113908517

传真 /Fax: 0760-23234333

olayks 便利轻生活家电品牌, 成立于 2020 年。供应链选择出口日韩外贸企业或自主生产, 选型出口原款, 产品获得日本 PSE 认证, 欧盟 CE/CB 认证、欧盟 ROHS 认证等相关专业认证, 确保产品质量高于行业平均水平。

Olayks is a brand of convenience light household appliances, which was established in 2020. Choose the supply chain to export to Japan and South Korea's foreign trade enterprises or produce independently, select the original export money, and obtain relevant professional certifications such as Japan PSE certification, EU CE/CB certification, EU ROHS certification, etc., to ensure that the product quality is higher than the industry average level.

## 主要展品 /Products

电饭煲、电煮锅、电烤盘、烤箱、电炖锅等等生活小家电。

Electric cooker, electric cooker, electric baking pan, oven, electric cooker, etc.



中山市派优宜电器有限公司

N3-3B35

Zhongshan PUE Electric Appliance Co., Ltd

地址: 中山市阜沙镇东阜公路 13 号 (首层第五间) (528434)

Add: No.13, Dongfu Road, Fusha Town, Zhongshan City

电话 /Tel: 0760-2349985

传真 /Fax: 0760-2349985

网址 /Web: www.puecn.com

品牌“PUE”是一家集小家电产品研发、制造、销售为一体的高新技术企业。产品涵盖电动类果汁机, 电热类的养生壶, 蒸煮饭盒, 电火锅电饭煲, 绞肉机, 折叠水壶等创意小家电系列产品; 每年各类小家电整机年生产能力达数百万台以上, 同时为知名品牌 THERMOS, TCL, 康佳, LOCK&LOCK 等提供 OEM 服务。公司具备六条国际标准化生产流水线及测试中心, 研发中心。总规模 8,000 多平方米, 其中 2,00 方是成品仓库。

PUE was established in April, 2018; Owned by Mr. Allan, who have more than 10 years of professional experience in home appliance industry before he started his own enterprise, PUE is engaged in R&D, manufacturing and marketing a widerange of small home appliances, Portable Blender USB Rechargeable, Miniblender, Milk frother, Foldable electric kettle, Multi-functional Health Kettle, De-Sugar Mini Rice Cook, etc. included. PUE carries out IQC standard in production and have testing room with all necessary equipment for quality test. ROHS, CE, CB, EMC, ERP, LFGB, REACH, etc. certificates are available for all exported products.

At present, we have established long term business relationship with Disney, Thermos, Konka,

Home, etc. from China, America, Japan, Vietnam, etc. both at home and abroad. Welcome to visit our factory to audit our facilities and test our quality for further deals

## 主要展品 /Products

电动类果汁机, 电热类的养生壶, 多功能饭盒, 电火锅电饭煲, 绞肉机, 折叠水壶等创意小家电系列产品  
Low suger rice cooker, Multi-functional health kettle, Multifunction Electric Cooking Pan, Multifunction Electric Cooking Pot, Mini Slow Juicer, Foldable Electric Kettle, Mini Chopper, Portable Food Heating Box/Lunch Box



中山市七酷电子科技有限公司

E3-3B46

Zhongshan Seven Cool Electronics Technology Co.,Ltd

地址: 广东省中山市东凤镇小沥社区富东街三巷 8 号 (三楼) (528425)

Add: No.8 Fudong 3 Street, Xiaoli Community, Dongfeng Town, Zhongshan City, Guangdong Province, PRC.

电话 /Tel: 0760-22775519

网址 /Web: www.7cooltech.com

中山七酷电子集研发、生产、销售和服务为一体家用美容仪器厂家。主营家用超声波铲皮仪, 美肤仪, 眼部按摩仪, 美眼笔, RF 射频美容仪, 热玛吉美容仪, 电动硅胶洁面刷, 纳米注氧仪, 祛痘仪, 等离子美肤仪, LED 子母化妆镜, 台式带灯化妆镜, 包包口袋镜, 运动美容水杯, 车载香薰加湿仪等原创设计产品和跨境电商持续爆品。乐意为新旧客户定制服务, 满足顾客个性化 ODM 和 OEM 服务, 积极开拓, 迎接新机遇, 携手并进, 共创辉煌。

Seven Cool / 7cooltech is a professional manufacturer of personal health care & beauty care device in south of China. Include portable ultrasonic skin scrubber, facial skin spatula, RF beauty instrument, plasma rejuvenation device, remove acne device, IPL removal hair instrument, electrical silicon cleaning brush, LED makeup mirror with 3X/5X spot mirror, desktop LED makeup mirror, pocket mirror, cosmetic mirror, ionic eye massager, beauty eye wand, smart massager scarf, Mini humidifier, car aromatherapy humidifier, sport water bottles, smart massager and other popular electric products and passed the FDA, PSE, CE, FCC, ROHS, KC certificates. We have gained top reputation as a reliable and honest partner in these years with most of our customers coming from referrals. Welcome to be our partners.

## 主要展品 /Products

七酷电子专业生产家用美容仪器, 家用超声波铲皮仪, 导出导入美肤仪, 眼部按摩神器, 美眼笔, RF 射频美容仪, 手持热玛吉美容仪, 美容导入仪, 硅胶洁面刷, 电动洁面仪, 纳米注氧仪, 脸部祛痘仪, 等离子去痘美肤仪, LED 子母化妆镜, 台面带灯化妆镜, 包包镜, 口袋镜, 运动美容水杯, 护目镜, 车载香薰加湿仪等原创设计产品和跨境电商持续爆品。

portable ultrasonic skin scrubber, facial skin spatula, RF beauty instrument, plasma rejuvenation device, remove acne device, oil stone roller, facial oil absorbing roller, Nano oxygen injector, IPL removal hair instrument, electrical silicon cleaning brush, LED makeup mirror with 3X/5X spot mirror, desktop LED makeup mirror, pocket mirror, cosmetic mirror, ionic eye massager, beauty eye wand, smart massager scarf, Mini humidifier, car aromatherapy humidifier, sport water bottles, body smart massager etc.



中山市千寿电器有限公司

ZHONGSHAN QIANSHOU ELECTRICAL APPLIANCE CO.,LTD

N3-3A37

地址: 广东省中山市东凤镇同安大道东路 35 号千寿 (528415)

Add: East Tong'an Road, Tong'an Village, Dongfeng Town, Zhongshan City, Guangdong, China

电话 /Tel: 18676187697

网址 /Web: https://qskom1688.1688.com/

中山市千寿电器有限公司成立于 2017 年, 主要生产电饭煲, 空气炸锅, 发酵机等家用电器, 公司专注于研发生产及销售, 拥有强大的生产实力, 专业的研发团队, 产品款式多, 资质齐全、质量稳定, 畅销各地, 深受广大消费者喜爱和好评。公司占地面积 6000 多平方米, 销售和管理团队 20 多人, 产线员工 70 多人, 技术人员和工程师 12 人。公司为康佳、四季沐歌、华帝、长虹等知名品牌客户提供 OEM/ODM 服务, 行业内认可度非常高。

Zhongshan Qianshou Electric Appliance Co., Ltd. was established in 2017, mainly produces rice cookers, air fryers, fermentators and other household appliances, the company focuses on R & D, production and sales, has a strong production strength, professional R & D team, product styles, complete qualifications, stable quality, best-selling all over the country, by the majority of consumers love and praise. The company covers an area of more than 6000 square meters, sales and management team of more than 20 people, production line employees more than 70 people, technical personnel and engineers 12 people. Provides OEM/ODM services for Konka, Siji Muge, Vatti, Changhong and other well-known brand customers, and the industry recognition is very high.

#### 主要展品 /Products

电饭煲、空气炸锅、黑蒜酵素机

Rice cooker, Air fryer, Black garlic machine



中山市荣星电器燃具有限公司

ZHONGSHAN CITY RONGXING ELECTRIC&CAS APPLIANCE CO.,LTD.

N1-1E81

地址: 黄圃镇大雁工业区广兴路与魁东三路交汇处 (528429)

电话 /Tel: 0760-23215199

传真 /Fax: 0760-23217618

网址 /Web: www.zsrongxing.com

中山市荣星电器燃具有限公司, 成立于 1997 年, 公司主要专注于厨卫产品的开发、生产和销售。公司产品以其独特的魅力, 畅销中国大江南北, 深受广大消费者的青睐与好评。经过多年发展, 荣星产品已形成以油烟机、燃气灶、消毒柜、燃气热水器、电热水器、蒸烤箱、净水器、水槽、水龙头为主的系列产品。荣星是最早生产嵌入式消毒柜的领导企业之一, 最新研发的吸油烟机系列荣获多项技术专利和外观专利产品经上市得到消费者的一致好评。

#### 主要展品 /Products

油烟机、燃气灶、消毒柜、燃气热水器、电热水器、蒸烤箱、净水器、水槽、水龙头



中山市升平热保护器有限公司

ZHONGSHAN SHENG PING THERMAL PROTECTORS CO.,LTC

W3-3A44

地址: 广东省中山市小榄镇骏业路二街 8 号 (528415)

Add: NO. 8, 2ND STREET, JUNYE ROAD, XIAOLAN TOWN., ZHONGSHAN CITY, GUANGDONG PROVINCE, CHINA

电话 /Tel: 0760-22106311

传真 /Fax: 0760-22115734

网址 /Web: http://www.sheng ping.com

公司生产热熔断路器和双金属型热保护器, 是技术成熟的专业型企业。

产品有四大系列:

- 1、RY SPF 系列有机化合物型热熔断路器
- 2、RS 系列双金属型热保护器
- 3、RH 系列低熔点合金型热熔断路器
- 4、KSD 系列双金属型温控器

公司有自主设计和开发能力, 具有目前国际先进水平的生产线。

“升平”牌热保护器产品已获多种认证。产品质量稳定可靠, 符合环保要求, 广泛用于家电行业。

主要展品 /Products

产品有四大系列:

- 1、RY SPF 系列有机化合物型热熔断路器
- 2、RS 系列双金属型热保护器
- 3、RH 系列低熔点合金型热熔断路器
- 4、KSD 系列双金属型温控器



中山市维塔普斯电器有限公司

Zhongshan Weplus Electric Appliance Co., LTD

N2-2A46

地址: 中山市黄圃镇盛红路 10 号 (528427)

Add: 10 Shenghong Road, Huangpu Town, Zhongshan City

电话 /Tel: 18100261883

传真 /Fax: 0760-85243265

中山市维塔普斯电器有限公司成立于 2010 年初, 前身是注塑工厂, 为小熊, 美的, 德尔玛, 等多家企业提供原材料和成品注塑件, 工人数量维持在 100 人左右, 年生产总值超过 5000 万, 单日各类成品数量可达 3500 件。

2017-2020 转型成为具有设计, 研发, 检测能力的全能型工厂, 有完整的原材料供应渠道, 工厂面积达到 1 万平方米以上, 员工 450+ 人, 拥有日生产空炸系列成品 1 万台的能力, 年产值约 2 亿元。

#### 主要展品 /Products

主要产品类型:

空气炸锅、破壁机、豆浆机、水壶、料理机、绞肉机、电火锅、电饭煲、电压力锅、电烤箱、养生壶等小家电类产品。





Wen Sheng

**中山市稳升电器有限公司****Zhongshan Wensheng Electric Appliance Co., Ltd****W4-4B52**

地址: 中山市阜沙镇东阜公路侧工业区内 A10-14 卡厂房 (528400)

Add: A10-14 card factory building in the industrial zone on the side of Dongfu Road, Fusha Town,

Zhongshan City

电话 /Tel: 0760-23123433

传真 /Fax: 0760-23123433

网址 /Web: wenshengdq.cn

本公司成立于 2009 年, 坐落于广东珠三角大湾区中山市, 是一家现代化、智能化、创新化、生产、销售、研发集一体的电加热元器件公司。

公司凝聚了一批有朝气、有理想、有素质的专业团队。严格遵照 ISO9000 质量体系去实现奋斗目标。目前公司产品主要服务于, 空气炸锅、空气烤箱, 烤盘、微蒸烤, 微波炉, 面包机等以电加热类大, 小用电产品。

现规模达到年产量 2000 万支以上供应能力, 被评为当地 A 级纳税单位的科技企业。

The company was founded in 2009, located in Zhongshan City, Dawan District, Pearl River Delta, Guangdong Province. It is a modern, intelligent, innovative, production, sales, research and development integration of electric heating components company. The company has gathered a group of professional teams with vitality, ideals, and qualities. Strictly follow the ISO9000 quality system to achieve the goals. Currently, the company's products mainly serve large and small electric products such as air fryers, air ovens, baking pans, micro steam roasters, microwave ovens, and bread makers. With a supply capacity of more than 20 million pieces per year, it has been rated as a technology enterprise with a local level A tax payer.

**主要展品 /Products**

电热元件

Electrothermal element

**vinnicave****中山市稳信电器实业有限公司****Winson Electrical Industrial Co., Ltd.****N4-4A27**

地址: 广东省中山市黄圃大雁工业区雁东二路 (528429)

Add: Yandong 2 Road, Dayan Industrial, Zhongshan Guangdong

电话 /Tel: 0760-22508678

传真 /Fax: 0760-22508679

网址 /Web: www.gdwincon.com

中山市稳信电器实业有限公司, 占地 30000 余平米, 是广东省高新技术企业之一、专业从事中高档家用与商用红酒柜、饮料柜、制冰机、啤酒机、冰箱等研发、生产、销售、售后于一体的制冷设备制造企业。

稳信始终以“专注、创新、专业、领先、高效、坚持、发展共赢”为理念, 年产高、中档红酒柜 30 万余台远销欧美、东南亚等世界各国, 与多家世界 500 强企业保持长期友好稳定的合作销售关系并深受好评。

**主要展品 /Products**

酒柜、饮料柜、制冰机、啤酒机、冰箱

**中山市小明电器有限公司****N3-3A50**

地址: 中山市黄圃镇魁中路 6 号 (528400)

电话 /Tel: 18319955755

中山市小明电器有限公司, 位于中山市黄圃镇魁中路 6 号 成立于 2020 年 8 月 17 日, 是一家专业研发制造资质许可范围内家用电器、五金等专业生产和销售的高科技企业。自成立以来, 我们秉承“精益求精、服务客户”的经营理念, 深获客户肯定。公司秉承“以人为本”管理概念, 同时公司推行客户利益, 员工利益及企业利益三者和谐统一的经营理念, 努力到达“三赢”共同目标, 并将“以有限的资源创造无限的可能”之创业精神永放光大。

**主要展品 /Products**

公司主要生产电炒锅, 电火锅, 养生壶, 电子饭盒等小家电产品。

**INWOOPA**

鑫虎'源自德国 精品之作

**中山市鑫虎生活电器有限公司****N2-2A20****zhongshanshixinhushenghudianqiyouxiangongsi**

地址: 广东省中山市南头镇建安路三号之一 (528400)

Add: guangdongshengzhongshanshijiananlu

电话 /Tel: 18924945201

传真 /Fax: 0760-23404349

匠心·一匠  
-BYZENG-**中山市一匠科技有限公司****W2-2C51****ZhongshanYijiang Technology Co., Ltd.**

地址: 中山市火炬开发区丰盛 5 号

Add: No. 5, Fengsheng Road, Torch Development Zone, Zhongshan City, Guangdong Province, China

电话 /Tel: 15907618941

广东匠心科技有限公司是一家致力于空气净化器、加湿器、美容产品等电器产品等电器产品研发、生产、销售、技术服务于一体的专业化高新科技企业。公司注册在深圳前海自贸区, 注册资金 1000 万。中山市一匠科技有限公司为匠心科技全资控股工厂, 成立于 2018 年 8 月, 坐落于中山市火炬开发区, 厂房面积为 22000 平方米, 拥有恒温恒湿无尘车间, 通过 ISO9001-2015 体系, ETL 等相关认证。

GuangdongJiangxinTechnologyCo., Ltdisa professional high-tech enterprise which commits to R&D, productionsalesandtechnicalservices of air purifiers, humidifiers, floor washers, beauty instruments and otherhomeappliances.The company registered in Qianhai Self-Trading zone of Shenzhen with regisiter capital CNY 10millions.

Zhongshan YijiangTechnologyCo.,Ltd is a wholly owned factory of Guangdong Jiangxin Technology Co.,Ltd,which wasestablishedin2018andlocated in Torch District of Zhongshan City with factory area of22,000 square meters,workshopandlaboratories underdust-free, constant temperature and humid- ity,and matchingtestingequipment(multi advanced complete machine



assembly lines, standard 3m<sup>3</sup>&30m<sup>3</sup>laboratories,complete machine air volume testing equipment, high and low temperature testingequipment,salt spray testing equipment, packaging drop testing equipment, concussion testingequipment,etc.).ThecompanyhaspassedISO9001-2015 system

#### 主要展品 /Products

空气净化器、加湿器  
air purifiers, humidifiers



#### 中山市易斯托电器有限公司

#### Zhongshan Easto Electric Appliance Co., Ltd

E3-3B23 3B24

地址：中国广东省中山市火炬开发区大环村展兴路8号(528400)

Add: No.8 Zhanxing Road, Dahuan Village, Huoju Development Zone, Zhongshan, Guangdong, China

电话 /Tel: 19876065174

传真 /Fax: Easto Group Ltd

网址 /Web: www.easto.net

易斯托集团有限公司, 创立于2006年6月, 从事小家电及个人护理的中高端产品的研发、生产和销售为一体。产品包括,个人护理系列:女士剃毛器,男士剃须刀,电推剪等产品;美发护发系列:卷直发器,直发梳,吹风机等;已拥有多项结构新型及外观专利。产品都有获得GS,CE,CB,ROHS和UL等全球主要国家和地区的各大认证。工厂获得ISO9001,ISO14001,BSCI,SEDEX等认证。

We Easto Group is specialized in designing, engineering and manufacturing of Hair Care products and Personal Care Products. Hair Care products such as hair clipper, BLCD hair dryer, hair straightener, hair brush and hair curler etc. Personal Care products like multifunctional men shaver/trimmer, lady shaver/trimmer etc.

EASTO also has own blade factory for R&D hi-tech blade and manufacturing base for finished products, as well as injection plant. Cooperated with top 500 companies and other famous companies.

Products certified GS, CE, REACH, ROHS and UL. Most importantly per the strictest standard of brand clients. Factory has passed the ISO9001,ISO14001,BSCI,SEDEX and so on.

#### 主要展品 /Products

女士剃毛器, 男士剃须刀, 电推剪, 卷直发器, 直发梳, 吹风机, 洗手液机等

Lady trimmer/shaver, men trimmer/shaver, hair clipper, hair straightener, hair curler, hair dryer,

soap dispenser and so on



#### 中山市优益电器实业有限公司

#### Zhongshan yoice electric appliance co ltd

N3-3H91

地址：中山市阜沙镇颂德路20号

Add: No. 20, Songde Road, Fusha Town, Zhongshan City

电话 /Tel: 0760-23123860

传真 /Fax: 0760-23123860

网址 /Web: http://www.yoice.com.cn/

中山市优益电器实业有限公司坐落于“小家电生产基地”广东中山, 产业链配套完善, 交通物流方便快捷。专注生产研发厨房 / 母婴小家电: 酸奶机、电煮锅、电热饭盒、电饭煲、煮蛋器、电热水壶、电火锅、养生壶、UV 调奶器、UV 消毒柜、暖奶器、婴儿辅食机、吸奶器、婴儿理发器、UV 烘干盒、湿巾加热器、消毒器等精品小家电,

Zhongshan Youyi Electric Appliance Industry Co., Ltd. is located in Zhongshan, Guangdong, the "production base of small household appliances", with perfect industrial chain and convenient transportation and logistics. Focus on the production and R & D of kitchen / mother and baby small appliances: yogurt machine, electric cooker, electric lunch box, electric rice cooker, Egg Cooker, electric kettle, electric hot pot, health pot, UV milk mixer, UV disinfection cabinet, milk warmer, baby food supplement machine, milk sucker, baby hairdresser, UV drying box, wet towel heater, sterilizer and other high-quality small appliances,

#### 主要展品 /Products

酸奶机、电煮锅、电热饭盒、电饭煲、煮蛋器、电热水壶、电火锅、养生壶、UV 调奶器、UV 消毒柜、暖奶器、婴儿辅食机、吸奶器、婴儿理发器、UV 烘干盒、湿巾加热器、消毒器等精品小家电,

Yogurt machine, electric cooker, electric lunch box, electric rice cooker, egg boiler, electric kettle, electric hot pot, health pot, UV milk mixer, UV disinfection cabinet, milk warmer, baby auxiliary food machine, milk sucking device, baby hairdresser,



#### 中山市域森电器有限公司

#### Zhongshan Yusen Electrical Co.,LTD

W4-4A36

地址：中山市黄圃镇兴圃大道西81号(528429)

Add: NO.81, xingpu road west,Huangpu town,Zhongshan city,Guandong

电话 /Tel: 0760-23509782

传真 /Fax: 0760-23509783

https://zsyusen.en.alibaba.com/?spm=a2700.11153138.mamo-user-profile.4.704d71d272gY0q

中山市域森电器有限公司位于中山市黄圃镇,域森电器专业制造可调温控器产品广泛用于取暖品、电烤箱、电熨斗、油炸锅等多种家用电器,起温度调节和控制保护作用,产品先后取得了美洲 CUL、欧洲 VDE 等认证,产品皆通过 10 万次寿命测试。

YUSEN 产品为慢动式快跳式和倾倒式开关,拥有在行业内十余年工作的技术、品质等管理多名,以“持续改善品质,诚信服务客户”为质量方针,向客户提供高品质的产品和完善优质的服务。

Zhong shan yusen electrical co, ltd is located in zhongshan huangpu town, the domains professional manufacturing adjustable thermostat, products are widely used in heating products, electric oven, a perfray, and so on many kinds Household appliances, the temperature adjustment and the control to protect, the products have been made America CUL, Europe VDE, such as the authentication, the products are all through the 100,000 times life test, YUSEN products for the DS series, divided into slow moving type(ds-m), quick jump type(ds-k) and dumping of temperature control switch(DS-M-T) The company has more than 10 years of work in the industry at the technology, good product Qualitative management, and in the name "continue to improve quality, the good faith service to the customers" as the quality policy, to provide the customers with high quality products and perfect and high quality service.

#### 主要展品 / Products

可调温控器, 双金属温控器  
bimetal thermostat, adjustable thermostat

*Bacchus*  
芭克斯

#### 中山市越海电器有限公司 Zhongshan Yehos Electrical Appliance Co., Ltd

**N4-4B30 4B31**

地址: 广东省中山市南头镇园林路9号  
电话 /Tel: 18680175790  
传真 /Fax: 0760-23772857  
网址 /Web: www.yehos.com

本公司产品为压缩机恒温酒柜、电子恒温酒柜, 客房小冰箱, 酸奶机, 自动售卖机, 雪茄柜以及植物柜等制冷产品, 旗下品牌 BACCHUS 芭克斯 (意为酒神), 享芥葡萄酒业内。我司制冷产品生产设备完善, 采用 ISO9001 质量体系产品取得 CEEMC、UL、GSCCC 等国际质量认证。我司酒柜畅销于中国、美国、英国、法国、澳大利亚, 西班牙日本和韩国等国内外市场。越海以产品质量为生命, 追求卓越, 创造完美。

#### 主要展品 / Products

恒温酒柜, 雪茄柜, 酒柜酒窖定制工程

*Better* 越好®

#### 中山市越好电器有限公司 Zhongshan Better Home Appliance Co., Ltd.

**N3-3A56**

地址: 广东省中山市南头镇建安路3号 (528427)  
Add: No. 3, Jian'an Road, Nantou Town, Zhongshan City, Guangdong Province, China  
电话 /Tel: 0760-23128295  
传真 /Fax: 0760-22518878  
网址 /Web: www.betterih.com

中山市越好电器有限公司成立于1999年, 是中国小家电和商用设备行业中优秀 OEM&ODM 企业之一。公司拥有现代化的厂房和装配车间, 稳定的检测设备和优秀的研发队伍, 多条达到国际先进水平的生产线和具备年产电磁炉超100万台的生产能力。公司所制造的产品包括电磁炉、保温板等多

个品种产品, 均已通过 ETL、KC、CE、CB 等多项国际认证, 产品畅销美加、欧洲等 30 多个国家和地区, 深受全球客户的喜爱。

Zhongshan Better Home Appliance Co., Ltd. (hereinafter referred to as Better) is founded in 1999. Now it is a global professional manufacturer and developer of induction cooker and one of the better OEM&ODM manufacturer in China's small household appliance and commercial induction equipment industry.

The company has modern workshops and advanced levels of product assembly plant; highly educated R & D team and excellent well-trained staffs; has reached the international advanced level more than the assembly line; with an annual output of high-quality Induction of over one million units. Most of products have passed ETL, FCC, GS, CE, KC, CB and many other international certifications, 90% of products are sold to USA, Germany, Netherlands, Russia, Korea, Malaysia etc. more than 80 countries and regions.

Company has established ISO9001: 2000 quality management system, SA8000 social accountability management system and passed BSCI audit.

#### 主要展品 / Products

家用电磁炉, 家用电陶炉, 嵌入式电磁炉, 嵌入式多头炉, 商用电磁炉, 保温板, 商用柜炉, 商用煲仔炉, 商用电磁扒炉

Home use induction cooker, Home use infrared cooker, Built-in induction cooker, Commercial induction cooker, Warming tray, High power commercial use induction stove, Commercial induction grill

*JOSOO* 掌声®

#### 中山市掌声电器有限公司 Zhongshan Josoo Electric Appliance Co., Ltd

**E2-2A46 2A47**

地址: 广东省中山市黄圃镇马新工业区启业北路9号 (528429)  
电话 /Tel: 0760-23309223  
传真 /Fax: 0760-23309226  
网址 /Web: www.gd-josoo.com

中山市掌声电器有限公司, 成立于2007年, 公司位于广东省中山市黄圃镇, 厂房面积约2万平方米, 一直致力于智能家电及其配件的研究、开发、生产和销售, 是一家实力雄厚、技术领先、产品齐全、配套完善的专业化智能家电制造企业。公司先后与国内外多个知名品牌进行了深度合作, 汇聚了行业内一流的生产、品控、技术、管理、销售人才。先后取得 CCC、CE、CB、GS 等认证, 并严格推行 ISO9001 的质量管理体系。

#### 主要展品 / Products

电饭煲、烤盘、空气炸锅、加湿器、红酒柜、雪茄柜、饮料柜



**中山市知新玻璃科技有限公司**  
**Zhong Shan Zhi Zin Glass Technology**

**W1-1C98**

地址: 中山市古镇镇镇教昌工业 49 号 (528422)

电话 /Tel: 13590889639

传真 /Fax: 0760-22319236

知新是一家专业化生产家电工艺玻璃研发、生产、销售服务于一体的企业。始建于 1989 年 2 月, 坚持秉承“以质取胜、以客为尊、管控风险、创新发展”的经营理念。经过二十多年来不懈的努力, 本公司拥有经验丰富的技术团队、现代化的企业管理模式、忠诚的员工团队和先进的自动化智能生产设备、管理系统、ISO9001: 2015 版质量体系认证等。自公司成立以来, 积极不断改善生产环境并多次通过了国家安全生产。

**主要展品 /Products**

钢化玻璃面板, 厨卫玻璃面板, 小家电玻璃面板, 科技玻璃面板等等



**中山市众安温控器有限公司**  
**Zhongshan Zhongan temperature controller Co., Ltd**

**W2-2B42**

地址: 广东省中山市东凤镇伯社区金怡南路 78 号

电话 /Tel: 13924976999

传真 /Fax: 0760-22129491

网址 /Web: www.zszhongan.cn

中山市众安温控器有限公司地处广东省中山市东凤电子城附近, 交通便利, 距广珠西线 3Km, 公司成立以来主要研发、生产和销售大电流温控器、化霜温控器及其它温度控制器, 2017 年荣誉获得高新技术企业, 公司拥有全自动组装设备与半自动检测设备;

本产品主要适用于(汽车、即热式电热水器、速热式电热水器、储水式电热水器、电热水龙头、电锅炉、壁挂炉、冷柜、工业暖风机等各种电发热设备);

**Company profile**

Zhongshan Zhongan temperature controller Co., Ltd. is located near Dongfeng Electronic City, Zhongshan City, Guangdong Province, with convenient transportation, 3km away from Guangzhou west line. Since its establishment, the company has mainly researched and developed, produced and sold high current temperature controllers, defrosting temperature controllers and other temperature controllers. In 2017, the company won the honor of national high-tech enterprise, with full-automatic assembly equipment and semi-automatic detection equipment;

This product is mainly suitable for (automobile, instant electric water heater, fast heating electric water heater, water storage electric water heater, electric faucet, electric boiler, wall mounted furnace, freezer, industrial heater and other electric heating equipment);

**主要展品 /Products**

公司成立以来主要研发、生产和销售大电流温控器、化霜温控器及其它温度开关。



**中山市众扬电器有限公司**  
**Zhongshan City Peofly Electric Co.,Ltd.**

**W3-3C61**

地址: 广东省中山市黄圃镇马新工业区祥安路 (528429)

Add: Xiangan Road, MaXin Industrial Zone, HuangPu Town, Zhongshan City, Guangdong Province

电话 /Tel: 0760-22502886

传真 /Fax: 0760-22502887

网址 /Web: http://shop1377536050526.1688.com

中山市众扬电器有限公司成立于 2003 年, 是一家专业专注电加热, 热交换领域的研发、生产、销售, 服务公司。产品包含铸铝发热体, 电热管及各类电热元器件、燃气水箱、无氧铜水箱及各类热交换器产品。公司已拥有自主知识产权的专业技术为依托, 紧密贴近客户, 持续为客户提供满意产品和解决方案, 以及主动的增值性服务, 力促产品发展升级。

Zhongshan City Peofly Appliance Co.,Ltd. (中山市众扬电器有限公司) is the first leading heat exchanger factory that is specialized in providing Coated-Tin Heat Exchanger、No-Oxygen Copper Heat Exchanger and Electric Heating Series of Designing, R&D, Production services. Peofly was founded in 2003, headquarter is based on Zhongshan City with 20,000 m<sup>2</sup>. 500 workers and State-of-the-art production facilities. It has an industrial leading R&D team and guarantees latest technology as well as innovative design outcomes. Focused on constant innovation and continuous improvement.

Peofly's product range covers a wide range of Home Appliance, as there are Gas/Electric Water Heater、Coffee Maker、Electric Faucet、Water boiler and so on.

For Over 20 Years, we cooperated with some famous home clients, such as Media、Haier、Best、Paite、Otlan and so on. For foreign Market, we had a market share of Taiwan、Russia、South America, especially in Chile.

**主要展品 /Products**

即热式电加热器, 电壁挂炉加热器, 咖啡机加热器, 即热式水龙头加热器, 蒸汽发生器加热器  
Instant Electric Water heater, Coffee Maker、Instant Electric Faucet、Electric Water Boiler and so on



**中山市卓杰奥电器有限公司**

**W4-4H86**

地址: 中山市黄圃镇置业路 3 号

电话 /Tel: 0760-88770681

中山市卓杰奥电器有限公司是一家酒柜、雪茄柜、牛排柜、饮料柜等制冷家电的研发、生产、销售于一体的企业。位于经济发达的中山市黄圃镇大岑工业区, 交通、运输十分便利。公司年产能达 10 万台, 新产品设计开发水平, 属于行业领先地位。公司一直注重科技领先, 主营出口业务, 与全球知名制造商, 大型家电连锁及超市建立了广泛的销售合作关系, 国际营销渠道普遍欧洲、美洲以及亚洲等地区, 荣获 30 多项国家专利, 发展非常迅速。

**主要展品 /Products**

主要产品有: 酒柜, 雪茄柜, 牛排柜, 饮料柜等



**拓飞科技****中山拓飞电器科技有限公司****W3-3A26 3A27**

地址: 广东省中山市南头镇升辉南路 71 号 (528427)

电话 /Tel: 0760-22517508

传真 /Fax: 0760-22517508

公司自成立以来,一直专注于 IMD/IML 面板工艺研发,已形成高产量模具设计、制造、丝印、注塑、组装等完善的产业链,引进国内外先进的生产和检测设备,拥有高精无尘丝印及注塑车间,配备模具制造车间、丝印车间、成型车间、注塑车间。

我司 IMD/IML 广泛应用于家用电器、数码电子、医疗器械、汽车装饰和触控面板等各个领域,凭高品质的 IMD/IML 产品和诚信服务赢得了客户的信任。

**主要展品 /Products**

IMD/IML

**中山腾威电器有限公司****N4-4A28**

地址: 广东省中山市横栏镇富庆一路 9 号永兴楼工业园

电话 /Tel: 18938703550

网址 /Web: www.zstengwei.com

中山腾威电器有限公司(中文商标:威默 英文商标:VMER)是华南地区专业生产净水 RO 泵、壁挂炉屏蔽循环泵、热水器增压泵,研发,销售于一体的公司,公司拥有在水泵、电机行业耕耘 10 多年经验的专业研发人员,拥有较强的开发能力,能定制各类专业水泵。公司产品通过了 CE、UL 及相关行业认证,产品符合 RoHS、REACH 等多项检测,以确保产品安全、稳定、可靠、耐用,并符合当地的法律法规要求。

**主要展品 /Products**

热水器水泵,水暖毯水泵,壁挂炉水泵,房车水泵,智能马桶水泵,净水器水泵,及各类型无刷直流水泵定制

**诺克司****中山天立卫厨有限公司****N1-1A27****ZhognshanTianLi Bath&Kitchen Co.,Ltd**

地址: 广东省中山市南头镇东福北路 74 号 C 栋 3 楼 (528400)

电话 /Tel: 18028360315

网址 /Web: www.knocs.com.cn

诺克司在 1995 年建立了全球采购供应体系和全球技术联盟,拥有自己独立的研发中心、实验室和三大制造中心(北美、澳大利亚、中国)。截至 1997 年,诺克司在加热技术与电控领域已经拥有多达 30 余项的发明专利,研发技术和制造水平水平进入国际先进行列。

**主要展品 /Products**

诺克司公司的系列大功率即热式电热水器、燃气热水器,储水热水器,速热热水器,即热迷你小厨宝等

**中山喜之堂电器有限公司****Zhongshan Sitom Electric Co., Ltd****N3-3B15**

地址: 广东省中山市黄圃镇康盛路 32-3 号 (528427)

电话 /Tel: 0760-89736777

传真 /Fax: 0760-89736789

网址 /Web: www.chinasitom.com

喜之堂于 2009 成立广东中山,我们一直致力于电压力锅的研发,并提供 OEM/ODM 服务。我们的工厂占地 7000 多平方米,通过从原材料采购到成品的严格测试和质量控制,产品符合 CE、CB、ROHS、ETL、COC 标准。我们的海外市场覆盖欧洲、美国、俄罗斯和东南亚。我们与国内外许多著名品牌和超市合作,甚至与许多海外知名品牌合作,如越南的 COMET、韩国的 SAKURA 等;

**主要展品 /Products**

电压力锅

**中山雅岚电器有限公司****Artair International Co., Ltd.****W5 5A46 5A45 5A44**

地址: 中山市西区蓝波路 9 号蓝波水岸华庭 2 卡一层 (528410)

Add: NO.,9, LANBO ROAD ,ZHONGSHAN CITY, GUANGDONG PROVINCE ,CHINA

电话 /Tel: 86-0760-89925700

传真 /Fax: 86-0760-89925700

网址 /Web: artairkorea.com

雅岚电器是世界上最早涉猎于移动空调与除湿机的专业公司,超过 100 款移动空调与除湿机,产品出口 80 多个国家与地区,代工品牌 100 多个,合作伙伴包括欧尚、家乐福、乐华梅兰等等,每年出口量超过 70 万台。

? 我们拥有“韩玛”、“雅岚”、“Artair”注册商标。? 产品已经进入国内各大超市,如苏宁、华润万家、大润发、壹加壹等等。? 雅岚电器除了推广自有品牌外,还接受除湿机、移动空调、净化器、窗机等代工。

**主要展品 /Products**

移动空调,除湿机,空气净化器

## 智选科技

中山智选科技有限公司

Zhongshan Zhixuan Technology Co., Ltd.

E3-3A12

地址: 广东省中山市东凤镇展业十八巷一号四楼 (528400)

Add: 4/f, No. 1,18Th Lane, exhibition industry, Dongfeng, Zhongshan, Guangdong

电话 /Tel: 13928625408

传真 /Fax: 076022775560

中山智选科技有限公司是主要以个人护理小家电: 声波电动牙刷、冲牙器、颈椎按摩仪; 厨房小家电: 智能消毒刀架、玻璃养生锅、养生壶等健康小家电为主的研发型制造企业。销售网络覆盖欧美 20 多个国家。并与多个国内和国际知名品牌及客户保持长久稳定的合作。

Zhongshan Smart Choice Technology Limited is a small home appliances for personal care: Acoustic Electric Toothbrush, toothbrush, cervical spine massager; Kitchen small appliances: intelligent disinfection knife rack, glass health pot, health care pot and other health-based small appliances R & D manufacturing enterprises. Sales Network covering more than 20 countries in Europe and the United States. And with a number of domestic and international well-known brands and customers to maintain long-term and stable cooperation.

### 主要展品 /Products

个人护理小家电: 声波电动牙刷、冲牙器、颈部按摩仪。

厨房小家电: 智能刀具消毒机、养生锅、养生壶。

Personal Care Small home appliances: Acoustic Electric Toothbrush, toothbrush, neck massager. Small kitchen appliances: smart knife disinfection machine, health pot, health pot.



重庆市迪山科技有限公司

Chongqing Dishan Technology Co., Ltd.

N2-2B21 2B22

地址: 重庆市南岸区南坪西路 73 号金阳阿凯德拾光里商务楼 16-17 (400000)

Add: No. 17, Floor 16, J. Y. Shiguangli Building, 73 Nanping West Road, Nan'an District,

Chongqing

电话 /Tel: 86-023-62643369

传真 /Fax: 86-023-62458797

网址 /Web: www.dishan-tec.com

重庆市迪山科技有限公司成立于 2006 年, 是一家专业从事纳米表面防护技术服务的现代化高科技企业。十六年来深耕纳米表面防护, 先后与美国 / 德国等发达国家的表面防护企业开展贸易技术合作, 引进国际领先的纳米易洁、纳米防油、纳米防霉等多功能产品、先进工艺和配套产品, 建立了易洁性能检测室, 自主研发了全自动易洁生产线。公司多年来推广纳米易洁技术在国内厨电、卫浴、建筑等领域应用, 与国内多家企业成为长期战略合作伙伴。

Chongqing Dishan Technology Co., Ltd. was founded in 2006. We are a professional high-tech enterprise specializing in surface protection nano-technology services. We have focused on nano-tech surface protection for more than 16 years. We have successively carried out trade and technical cooperation with surface protection companies in the USA, Germany and other developed countries as well as imported advanced types of nano products such as EC, oleophobic, mildew proof and other multifunctional products. We import advanced EC process

technology and supporting product sets as well. We have an EC performance testing lab, self-designed and developed EC automatic production line, and built a comprehensive operation and service network. Over the years, we have promoted EC nanotechnology in domestic market fields such as kitchen appliances, sanitary ware, construction, etc. and has become a long-term strategic partner with many enterprises.

### 主要展品 /Products

- 1、EZHD 易洁养护剂
- 2、EZSS 不锈钢易洁养护剂
- 3、BVGOT 防油易洁剂
- 4、BVSOT 不锈钢防油剂
- 5、MMOT 石材防油剂
- 6、EZGOT 玻璃防油剂
- 7、厨房去污套装
- 8、厨房易洁护理套装
- 9、厨房易洁修复套装
- 10、全自动易洁生产线
- 1、EZ ARMOR Hydrophobic Coating
- 2、EZ ARMOR Stainless Steel Hydrophobic Coating
- 3、EZ ARMOR Hydro-Oleophobic Treatment
- 4、EZ ARMOR Stainless Steel Oleophobic Treatment
- 5、EZ ARMOR Stone Oleophobic Coating
- 6、EZ ARMOR Glass Oleophobic Coating
- 7、Kitchen Stain Remover Set
- 8、Kitchen Clean Care Set
- 9、Kitchen EC Restoration Set
- 10、EC Automatic Production Line



珠海格力电器股份有限公司

Gree Electric Appliances, Inc. Of Zhuhai

W2-2C11 2C31

地址: 珠海横琴新区汇通三路 108 号办公 608 (519031)

Add: Room 608, No.108 Huitong Third Road, Hengqin New Area, Zhuhai, Guangdong, China

电话 /Tel: 0756-8614883

传真 /Fax: 0756-8627141

网址 /Web: www.gree.com

珠海格力电器股份有限公司成立于 1991 年, 1996 年 11 月在深交所挂牌上市。公司成立初期, 主要依靠组装生产家用空调, 现已发展成为多元化、科技型的全球工业制造集团, 产业覆盖家用消费品和工业装备两大领域, 产品远销 180 多个国家和地区。公司现有近 8.2 万名员工, 其中有近 1.6 万名研发人员和 3 万多名技术工人。覆盖从上游生产到下游回收全产业链, 实现了绿色、循环、可持续发展。

Gree Electric Appliances, Inc. Of Zhuhai was founded in 1991. At the beginning of its establishment, the company mainly relied on the assembly and production of household air conditioners. Now it has developed into a diversified and high-tech global industrial group, covering air conditioners, household appliances, high-end equipment, communication equipment and other fields, and its products have been exported to more than 180 countries and regions.

Gree has 80,000 employees, including 15,000 engineers and over 30,000 technical workers. Covering the entire industrial chain from production to recovery of waste products, for green, recyclable and sustainable development.

#### 主要展品 /Products

产品覆盖智能家居、家用空调、家庭中央空调、空气能热水器、生活电器、冰箱、厨房电器、工业制品、智能装备、模具等消费品和工业装备两大领域。

Gree has assembled its business to household consumer goods and industrial equipment, including Smart Home, residential Air conditioners, central air conditioners, air source water heaters, home appliances, refrigerators, kitchen appliances, industrial goods and intelligent equipment etc.



#### 珠海格力电器股份有限公司

#### Gree Electric Appliances Inc. of Zhuhai

W2-2C01

地址: 珠海横琴新区汇通三路 108 号办公 608 (519031)

Add: Room 608, No.108 Huitong Third Road, Hengqin New Area, Zhuhai, Guangdong, China

电话 /Tel: 0756-8614883

传真 /Fax: 0756-8627141

网址 /Web: www.gree.com

格力电器为多元化、科技型的全球工业集团, 产业覆盖家用消费品和工业装备两大领域, 产品远销 180 多个国家和地区, 据日经社 2019 年统计发布, 家用空调占有率连续 14 年全球第一。格力坚持营销、管理、人才、技术“四个创新”, 始终牢牢掌握发展主动权。在 2019 年国家知识产权局排行榜中, 格力电器排名全国第六, 家电行业第一。现拥有 37 项国际领先技术, 获国家科技进步奖 2 项、国家技术发明奖 2 项, 中国专利金奖 3 项。

Gree Electric Appliances, Inc. of Zhuhai is a diversified technological global industrial group, whose business covers household consumer goods and industrial equipment. Products are sold widely in more than 1801 countries and regions. According to the 2019 Nikkei newspaper, Market share of Gree residential air conditioner topped No.1 in the world for 14 consecutive years.

Gree always insists “four innovations” — marketing innovation, management innovation, talent innovation and technology innovation. On the list of 2019 China invention patents published by China National Intellectual Property Administration, Gree ranked No.6 in China and No.1 in the home appliances industry for its number of granted patents. Now Gree has obtained 35 world-leading technologies, 2 National Science and Technology Progress Awards, 2 National technology innovation awards and 3 China Patent Gold Awards.

#### 主要展品 /Products

系统的暖通空调; 智能家居; 空气净化器、风扇、取暖器等环境电器; 电饭煲、电压力锅、净水机、烟机、炉灶等厨房电器; 空气能热水器、冰箱、洗衣机等消费家电产品。

Residential air conditioners, central air conditioners, heating and ventilation system products, smart home products, air purifier, fan, electric heater, rice cooker, pressure cooker, water purifier, range hood, gas stove, air source water heater, fridge



GIICARE

#### 珠海集致科技有限公司

#### Zhuhai Jizhi Technology Co., Ltd

E3-3A25

地址: 广东省珠海市高新区唐家湾镇南方软件园 D2-313 (519000)

Add: D2-313, Nanfang Software Park, Tangjiawan Town, high tech Zone, Zhuhai City, Guangdong Province

电话 /Tel: 0756-3288682

传真 /Fax: 0756-3288682

网址 /Web: www.giicare.com

珠海集致科技有限公司是一家专注于个人护理电器的互联网科技公司, 专注于个护电器的产品研发、供应链整合及互联网销售。

我们的愿景是以科技加美学的理念来打造新国货产品, 成为年轻人喜爱的个人护理潮品牌, 希望能让更多年轻人爱上精致护理的新生活方式、爱上新的中国制造产品。

#### 主要展品 /Products

电吹风, 电动牙刷, 冲牙器

Hair dryer, Electric toothbrush, Water flosser



#### 珠海市奥斯陆新材料有限公司

#### ZHUHAI OSLO NEW MATERIAL CO., LTD

W4-4A38

地址: 广东省珠海市香洲区珠海大道 33 号

电话 /Tel: 13825610597

网址 /Web: www.zhoslo.com

珠海市奥斯陆新材料有限公司位于广东省珠海市香洲区, 主要业务为玻璃 / 金属抗菌涂层, PET 防雾膜, 玻璃抗菌防霉液的供应。公司在为不同行业提供抗菌、抗病毒等领域表面处理技术和解决方案, 在玻璃、金属高端表面处理产品方面拥有多年的经验, 提供安全可靠涂层技术。

公司对材料表面处理有丰富的经验, 通过多年的生产实践中, 不断开发创新产品表面处理的解决方案及工艺, 提倡节能环保、科技创新理念, 致力为客户提供优质的服务。

#### 主要展品 /Products

玻璃抗菌涂层, 金属抗菌涂层, PET 防雾膜, 玻璃抗菌防霉液等

## dreame 追觅

追觅科技  
dreame

E1-1E21

地址: 江苏省苏州市吴中区吴中大道 2288 号尚金湾总部经济园 (215000)  
Add: Shangjiwan Headquarter, Economic Garden, 2288 Wuzhong Blvd, Suzhou,  
Jiangsu 215000, China  
电话 /Tel: 400-875-9511  
传真 /Fax: 400-875-9511  
网址 /Web: <https://www.dreame.tech/>

追觅是一家专注智能生活家电的全球化科技公司, 于 2017 年创立。自创立以来, 追觅不断求索创新, 在高速数字马达、智能算法、流体力学及机器人控制等方面, 拥有一系列授权专利并处于世界领先地位。为满足全球消费者多样化需求, 追觅不断探索和优化智能生活细分场景, 推出了扫地机器人、吸尘器、洗地机、高速吹风机四大品类, 并持续拓新。目前, 追觅产品已经覆盖包括中国、俄罗斯、东南亚、德国、美国在内的 100 余个国家和地区。

Dreame Technology specializes in the research and development of smart home appliances, aiming to make intelligent, healthy lifestyles easily accessible to global consumers. Starting life as an organization known as Skyworks based at Tsinghua University, Dreame has since grown into a leading technology company.

Today, Dreame is a major global company with a presence in around 100 markets around the world. With 50% year-on-year increase in sales base, Dreame has become a world-leading manufacturer of intelligent electronics products for home and consumer use.

### 主要展品 /Products

扫地机器人、无线吸尘器、洗地机、高速吹风机  
ROBOT VACUUM, CORDLESS STICK VACUUM, WET AND DRY VACUUM, HIGH SPEED HAIR DRYER

## CUORI卓力

卓力电器集团有限公司

E1-1F41

地址: 慈溪市周巷镇开发路 48 号 (315300)  
电话 /Tel: 0574-63323888  
传真 /Fax: 86-574-63302722  
网址 /Web: <http://www.cuori.cn/>

卓力电器集团创立于 1993 年, 是一家集家电产品设计、研发、生产、销售、出口、服务于一体的全球小家电制造商。CUORI 卓力始终专注于熨烫领域, 现依托全球熨烫资源, 构建了国际化的时尚视野和行业领先的创新实力。凭借在熨烫技术、面料研究等领域的不断突破, 卓力引领着行业的思潮升级, 更为所有精致生活的美妙创想, 提供更加专业的熨烫支持。

### 主要展品 /Products

卓力增压智能整烫系统、卓力增压智能挂烫机、卓力增压蒸汽熨烫机、卓力多功能手持挂烫机、卓力多功能烘干机、卓力无线折叠衣物消毒盒等



宁波比爱她智能科技有限公司

Ningbo BAT-X Intelligent Technology Co., Ltd

W3-3C112

地址: 浙江省余姚市低塘街道余慈公路 85 号 (315400)  
Add: No. 85, Yuci Road, Di tang Town, Yuyao City, Zhejiang Province  
电话 /Tel: 0574-22651898  
传真 /Fax: 0574-22651898  
网址 /Web: <http://www.bright-technologies.com/>

宁波比爱她公司是一家集研发、生产、销售为一体的智能健康小家电生产厂家。公司专注于新颖的汽车、居家、酒店等场景的卫生、清洁礼品的开发生产及销售。同时承接 OEM 订单, 按照客户的具体要求, 我司为之设计并生产出各种特色的产品, 产品以合理价格、高品质博得了客人的盛誉, 在国内外客户中建立起了良好的口碑。

Ningbo BAT-X Company is a manufacturer of intelligent and healthy small household appliances that integrates research and development, production, and sales. The company focuses on the development, production, and sales of hygiene and cleaning gifts for novel automotive, home, hotel, and other scenarios. At the same time, we undertake OEM orders, and according to the specific requirements of customers, our company designs and produces various distinctive products. The products have won a high reputation among customers at reasonable prices and high quality, and have established a good reputation among customers at home and abroad.

### 主要展品 /Products

智能感应皂液器 / 智能感应垃圾桶 / 智能感应夜灯 / 两季电器等, 适合内外销、礼品渠道等。  
intelligent sensing soap dispenser/intelligent sensing trash can/intelligent sensing night light/two season appliances, suitable for domestic and foreign sales, gift channels, etc.

## 金浴洁

瑞安市威鹏家用电器有限公司

WEIPENG

N1-1A41

地址: 浙江省瑞安市南滨街道邮电北路 39 号 (325400)  
电话 /Tel: 0577-65590707

瑞安市威鹏家用电器有限公司是新生代家用小电器制造与销售企业。本公司秉承绿色、健康、时尚、诚信的经营理念, 为广大消费者开发生产高端优质的家用小电器产品, 我们不仅仅是家电制造商, 更是优质高端生活供应商, 健康生活理念输出者。本公司拥有现代化生产车间 10000 余平方米, 生产员工 50 余人, 专业研发人员 10 余人, 150 克—1500 克注塑机械十台, 具备模具开发设计能力。本公司注重品质, 严守信誉, 愿与广大客户建立长期稳固的合作关系, 谋发展共进步。

### 主要展品 /Products

电动洗漂刷、电动擦背机器人、注氧仪、电动拖把、按摩枪



**DERUSI 德瑞斯****宁波市海曙德瑞斯标识有限公司****W1-1A47**

地址: 浙江省宁波市海曙望春工业区杉海路 188 号 (315010)

电话 /Tel: 13586525084

宁波市海曙德瑞斯标识有限公司是一家集广告系列产品设计、开发、制作为一体的综合性广告企业, 主营为发光标识系列产品, 于 2022 年五月已通过 ISO9001 质量管理体系认证。公司拥有自动折弯机、金属光纤切割机、普通亚克力雕刻机、迷你字雕刻机、激光雕刻机、激光焊接机、激光手持焊接机、爱普生写真机、UV 机、磨切机等各类制作设备。欢迎新老朋友前来参观考察。

**主要展品 /Products**

发光标识

**KAFFEE**  
ELECTRIC APPLIANCE**宁波可凡电器有限公司****E1-1C97****Ningbo Kaffee Electric Appliance Co., Ltd**

地址: 浙江省余姚市三七市工业园区园二路 6 号 (315400)

Add: No.6 Yuaner Rd, Sanqi Industrial Park, Yuyao, Zhejiang, China

电话 /Tel: 0574-62648885

传真 /Fax: 0574-62648885

网址 /Web: www.kaffeeelec.com

宁波可凡电器有限公司是自主研发制造销售奶泡机、咖啡机于一体的高新技术企业, 先后被评定为国家科技型中小企业、国家高新技术企业、浙江省高成长科技型中小企业、宁波专精特新企业、宁波制造业冠军培育企业等。公司拥有自己的设计研发中心, 测试实验室和生产基地, 并致力于成为全球领先的咖啡及周边设备制造商。

公司自主研发并拥有全球专利的奶泡机已与欧洲、北美、澳洲等数十个国家和地区的著名品牌有着良好的业务合作, 已跻身海外奶泡机制造品牌第一方阵。

Ningbo Kaffee Electric Appliance Co., Ltd. is a high-tech enterprise that independently develops, manufactures and distributes milk frothers and coffee machines. The company has its own design and development center, testing laboratory and production base, and is committed to becoming the world's leading manufacturer of coffee and peripheral equipment.

The company's self-developed milk frother with global patents has established good business cooperation with famous brands in dozens of countries and regions such as Europe, North America, and Australia, and has become the first phalanx of overseas milk frother manufacturers.

**主要展品 /Products**

奶泡机、全自动咖啡机、多合一胶囊咖啡机、K-cup 咖啡机

Milk Frother, Bean to cup coffee machine, All-in-one capsule coffee machine, K-cup coffee machine

**AOE****东莞市先端光电科技有限公司****E1-1C91****AOE**

地址: 东莞市企石镇莫屋村发展路 5 号 3 号楼 (523502)

电话 /Tel: 0769-38826226

公司成立于 2018 年 4 月, 位于东莞市企石镇, 从韩国引进了先进的光刻设备, 是目前国内光刻设备里可制作有效面积与精度的天花板。应用在外观视觉纹理制作上。团队专门致力于国内领先的 UV 纹理研发。AOE 拥有设备和设计纹理制作方面的多项专利技术; 拥有实力强大的纹理设计团队和后期 CMF 设计团队, 专门服务于各大终端的 CMF 团队, 提供针对性的纹理方案与 CMF 方案。AOE 的创新能力及发展潜力得到了众多高端客户群的多方肯定。在材料方面, 团队有基材方面的丰富背景, 对于国内外的新型材料与高端特殊材料资源整合方面有敏锐的嗅觉和超前的思维。已经获得多个特殊材料的中国国内独家代理权。公司在韩国, 日本都有分公司, 也与多个实验室合作研发新技术新材料。

**主要展品 /Products**

模具 膜片

**Amass****常州市艾迈斯电子有限公司****E1-1C96****CHANGZHOU AMASS ELECTRONICS CO.,LTD**

地址: 常州市武进区礼嘉镇秦巷村委漕桥 211 号

Add: Jiangsu Changzhou Wujin Lijia Town Industrial Park

电话 /Tel: 0519-86731695

网址 /Web: www.china-amass.com

迈斯电子有限公司创立于 2002 年, 倾注所有热情、知识和技术, 不断提升锂电动力连接器的可靠性和性价比。

连接细分领域, 近百项专利, 拥有 8 大产品系列, 涵盖 10-300 安培, 200 多款满足各种应用场景的动力连接器;

高效的产品研发和线束加工服务, 为以锂电池为动力系统的相关行业提供全案支持。

Changzhou Amass Electronics Co., Ltd. was founded in 2002. It has devoted all its enthusiasm, knowledge and technology to continuously improve the reliability and cost performance of lithium battery power connectors.

Focusing on the subdividing field of lithium battery connection, it has more than 200 patents, eight product series, covering 10-300 amperes, and more than 200 types of power connectors to meet various application scenarios;

At the same time, it provides efficient product research and development and harness processing services, and provides full case support for related industries with lithium battery as the power system.

**主要展品 /Products**

动力连接器 / 电池连接器 / 电机连接器 / 控制器连接器

Power connectors/Battery connectors/Motor connectors/Controller connectors



NIUFULAI

乐清市纽福莱电子有限公司

YUEQING NIUFULAI ELECTRONIC CO.,LTD

E1-1C92

地址: 浙江省乐清市天成街道宁康东路 2896 号

电话 /Tel: 0577-61367666

网址 /Web: www.niufulai.com

纽福莱电子有限公司始创于 1992 年, 是专业从事精密电子、电器开关、汽车配件开发、生产、销售于一体的企业。公司目前在浙江、广东拥有两大生产基地, 公司总部位于中国模具之都、中国电子元器件生产基地 - 乐清市, 厂房建筑面积 2 万余平方米。

Nuflair Electronics Co., Ltd. is an enterprise specializing in the development, production and sales of precision electronics, electrical switches and auto parts. The company currently has two production bases in Zhejiang and Guangdong, the company headquarters is located in Yueqing City, the capital of molds in China and the production base of electronic components in China, with a plant construction area of more than 20,000 square meters.

**主要展品 /Products**

公司生产的主要产品有: 船型开关、旋转开关、微动开关、按钮开关、温控开关、汽车空调控制器、座椅调节开关、升降开关、微型隔膜水泵、防倾倒开关等。

The main products produced by the company are: rocker switches, rotary switches, micro switches, push button switches, temperature control switches, automotive air conditioning controllers, seat adjustment switches, lifting switches, miniature diaphragm water pumps, anti-tipping switches, etc.



上海三间维科技有限公司

Shanghai Sanjianwei Technology Company LTD.

W5-5C82

地址: 上海静安区汶水路 451 号大众东朔空间 812 室 (200040)

Add: Room 812, 451 Wenshui Road, Jing'an District, Shanghai

电话 /Tel: 13661633456

网址 /Web: www.kjhy2019.com

上海三间维科技有限公司成立于 2019 年, 本公司主要专业从事全息幻影设备研发、生产、销售、设备租赁、全息影像视频内容制作、交互式内容开发等业务公司拥有独立知识产权的标准化幻影系列产品以及可根据客户需求设计定制的服务。公司产品主要应用领域企业展厅展会展馆、科技馆、博物馆、商业空间、全息教育设备、广告媒体、活动发布会等。我司致力于全息幻影技术的深度开发为客户打造世界顶级全息产品。

**主要展品 /Products**

幻影盒、幻影球、幻影墙、无框幻影机、四面幻影机



宁波普净科技有限公司

NINGBO PROCLEAN CO.,LTD.

E1-1C98

地址: 浙江省宁波杭州湾新区庵东镇工业园区纬一路 458 号 (315327)

Add: 458 Weiyi Rd. Andong Industrial Zone, Hangzhou Bay New Area, Ningbo, China

电话 /Tel: 13661633456

网址 /Web: www.kjhy2019.com

宁波普净科技有限公司成立于 2015 年, 专业从事于研发、制造、销售清洁类家用电器(无线吸尘器, 无线洗地机等)。公司坐落于浙江省宁波市杭州湾新区, 厂房面积 20000 余平方米, 自有注塑车间, 模具车间及实验室, 4 条吸尘器组装线, 员工 200 余人, 具有丰富的吸尘器, 洗地机设计制造经验。

公司以外贸出口业务为主, 产品主要销往欧美、日韩等发达国家, 经性能、寿命、碰撞、跌落等几十项严格测试, 确保出厂品质。

欢迎广大客户莅临参观!

Ningbo ProClean Co. Ltd established in 2015, the company is located in Ningbo city of Zhejiang, which are focus on household cleaning products development (Cordless Vacuum Cleaner, Cordless Wet&Dry Vacuum Cleaner, etc.). We have our own industry design center, product design & development center, test laboratory and manufacturing base. Our products are sold over the world such as USA, Europe, Korea, Japan, and other developed countries.

**主要展品 /Products**

无线吸尘器, 无线洗地机

Cordless Vacuum Cleaner, Cordless Wet&Dry Vacuum Cleaner



上海熠速信息技术有限公司

Shanghai YISU Information Technologies Co.,Ltd.

W4-4B41

地址: 上海市松江区九新公路 877 号 2 号楼 4 层 (201615)

Add: 4 / F, Building 2, No. 877 Jiuxin Road, Songjiang District, Shanghai

电话 /Tel: 021-64886750

传真 /Fax: 021-64886750

网址 /Web: www.yisuworld.com

上海熠速信息技术有限公司(简称“熠速”), 2017 年 3 月成立于中国上海, 是一家持续和快速成长的高科技企业, 通过与国际一流厂商的强强联合, 聚焦设计、开发和测试领域, 为保证用户的产品质量提供一流的研发工具、工程咨询以及培训等多种产品与服务。目前熠速与瑞士 Speedgoat 公司合作, 在实时仿真与测试方面提供专业解决方案; 与加拿大 Crank 公司合作, 提供嵌入式 GUI 设计和开发解决方案。



深圳市百昌科技有限公司

Shenzhen Baichang Technology Co., Ltd

地址: 广东深圳市宝安区沙井街道沙三路沙二工业区 B 栋 2 楼

电话 /Tel: 0755-29876366

E3-3B12

公司成立于 2012 年, 位于深圳沙井, 拥有 8000 平米厂房, 是集研发、设计、生产、销售于一体的专业生产商。主营按摩类和美容仪产品, 其产品的创作灵感来源于时下年轻人对个性风格, 生活品味的追求, 产品拥有前卫的设计理念和精湛的设计工艺, 引领着时尚达人办公白领的消费潮流, 专业的设计、研发、工程团队为产品创新提供源源不断的灵感, 为产品品质保驾护航, 各类电子产品也拥有众多专利等知识产权。

为客户提供 OEM/ODM 定制服务, 欢迎企业和社会各界人士前来洽谈业务、交流与指导。

#### 主要展品 /Products

1. 健康类: 筋膜枪, EMS 脉冲按摩贴, 头部按摩器, 腰部按摩器等 2. 美容类: 射频美容仪, 黑头仪, 美颜仪, 眼袋美眼仪, 超声洁面仪等。



思微自控科技(乐清)有限公司

iSwell AutoControl Technology (Yueqing) Co., Ltd.

地址: 浙江省乐清市经济开发区纬十七路 261 号

Add: No. 261, Wei 17 Road, Economic Development Zone, 325600 Yueqing,

Zhejiang Province, China

电话 /Tel: 18958767111

网址 /Web: www.iswell.com

W5-5C83

iSwell 为家用电器和暖通空调行业设计, 研发, 制造蜡马达驱动器, 为客户提供 OEM/ODM/JDM 服务。

iSwell designs, engineers, manufactures, and provides OEM/ODM/JDM services for wax-driven actuators for Home Appliances and HVAC industries.

#### 主要展品 /Products

蜡马达, 电动推杆, 热动执行器

waxmotor,thermoactuator,electric actuator

XPOWER

相與科技(上海)有限公司

Shanutec

W3-3C118 3C119

地址: 上海市黄浦区新闸路 356 号 悦达黄浦河滨大厦 1204 (200000)

Add: 1204, Yueda Huangpu Riverside Building, No.356, Xinzha Road

电话 /Tel: 4008206930

网址 /Web: www.shanutec.com

相與科技 (shanutec.com) 独创 XPOWER 移动电力轨道, 取代费时污染墙面的墙插座、杂乱安全隐患的拖线板, 随用随插、实用方便, 致力成为新的室内电力 / 通信、智慧楼宇底层接入标准。XPOWER 面向消费升级, 高贵不贵; 面向千亿元级装修隐蔽工程 + 拖线板大市场, 独有专利无同质化产品, 定价权高利润大; 面向智慧城市, 商业模式粘度高弹性大扩展广。

Xiangyu Science and Technology (shanutec.com) has created Xpower mobile power track, which replaces the wall socket that wastes time and pollutes the wall and the messy tow board with potential safety hazards. It is practical and convenient to plug in at any time, and is committed to becoming a new access standard for indoor power/communication and intelligent building ground floor. Xpower for consumer upgrade, noble and inexpensive; For hundreds of billions of hidden decoration projects + drag line board market, unique patents without homogeneous products, high pricing power and large profits; For smart cities, the business model is highly viscous and flexible.

#### 主要展品 /Products

XPOWER (艾宝沃) 高端定制轨道插座

XPOWER innovative power system

RCL<sup>®</sup>

宁波实隆轴承有限公司

NINGBO SHILONG BEARING CO.,LTD

E1-1C93

地址: 浙江省宁波杭州湾新区滨海三路 112 号 (315336)

Add: No.112, Binhai Three Road, Hangzhou Bay New Zone Ningbo City, Zhejiang Province, China.

电话 /Tel: 0574-63196608

传真 /Fax: 0574-63199886

网址 /Web: www.clzc.com

宁波实隆轴承有限公司 (RCL) 坐落于浙江省宁波市杭州湾新区。公司占地面积 17000 m<sup>2</sup>, 建筑面积 26000 m<sup>2</sup>, 致力于研发生产高精度, 低噪音的微型薄壁轴承、深沟球轴承。公司成立于 2009 年, 先后通过 ISO9001, ISO14001, IATF16949 管理体系认证。行业的发展和日益竞争的市场给我们带来了机遇和挑战, 我们以客户需求为中心, 以技术创新和产品开发为手段, 积极推进企业的产品、管理和技术发展, 成为国内薄壁轴承品质精良, 性价比高的企业。

Below we would like to share with you:

Every industry has its own challenges, but all industries share the goals of increased machine lifespan, reduced maintenance, improved safety, energy savings and lower Cost of Ownership. With rich experience as a technical partner to both manufacturers and end users in Bearing's application industry, RCL is delivering not just products but integrated solutions that help our clients achieve their goals.

#### 主要展品 /Products

薄壁轴承, 深沟球轴承

Thin section bearings, Deep groove ball bearings

**杭州艾达普智能科技有限公司****W3-3C117****Hangzhou Adaprox Intelligent Technology Co., Ltd.**

地址: 杭州市滨江区长河街道江虹路 333 号研祥科技大厦 A 幢 6 层 606 室 (310000)

Add: Unit 606, Yanxiang Science &amp; Technology Mansion No. A, 333 Jianghong Road, Binjiang District, Hangzhou, Zhejiang, China, 310052

电话 /Tel: 15067102928

网址 /Web: www.adaprox.io

Adaprox 致力于设计和生产用户友好的智能家居产品。我们以高品质和实惠的价格提供智能家居产品。我们用户友好的移动应用程序使您可以快速设置设备并轻松与您的所有智能设备打交道。我们的使命是将每个未连接的家庭连接到物联网, 并使其成为智能家居。

Adaprox dedicates to the design and production of user-friendly smart home products. We provide smart home products at high-quality and affordable prices. Our user-friendly mobile apps make it possible for you to quickly set up the devices and easily get along with all your smart devices. Our mission is to connect every unconnected home to the Internet of Things and make it a SMART HOME.

**主要展品 /Products**

手指机器人, 红外射频氛围灯三合一遥控器, 光照 PIR 情景开关三合一人体传感器 (Zigbee 与低功耗 WiFi 双版), 门磁情景开关二合一传感器 (Zigbee 与低功耗 WiFi 双版), 温湿度传感器 (Zigbee 与低功耗 WiFi 双版)

Fingerbot Plus, IR/RF/Ambient Light 3-in-1 Universal Remote, PIR/Light Sensor/Scene Buttons 3-in-1 Motion sensor (Zigbee and low-consumption WiFi versions), Contact Sensing/Scene buttons 2-in-1 contact sensor (Zigbee and low-consumption WiFi versions), Temperature Sensor (Zigbee and low-consumption WiFi versions)

**AIHEU 艾和友****深圳市东芯电控技术有限公司****W5-5C81****Shenzhen Dongxin Electric Control Technology Co., Ltd**

地址: 深圳市宝安区燕罗街道塘下涌社区同富路 10 号 G 栋 101 (518105)

Add: 101, Building G, No. 10 Tongfu Road, Tangxiayong Community, Yanluo Street,

Bao'an District, Shenzhen

电话 /Tel: 13530165821

网址 /Web: https://shop7j7762x876095.1688.com

公司于 2013 年在深圳创立。创立以来公司以健康生活为目的, 智造更多高品质健康护理产品, 旨在成为消费者信赖的制造商及品牌商。公司主营按摩理疗、个人护理仪器、EMS 按摩仪、气囊按摩产品、石墨烯发热产品、发热护具周边电子产品等。且拥有近十余家参股公司和全资子公司。

公司始终坚持以创新、品质、服务、节约、敬业、感恩, 12 字理念。吸收新创意, 严把质量关口全方位服务跟踪, 坚持做出高品质产品。我们厚积而薄发, 加强团队合作, 培养和引进高端人才以人为本, 鼓励员工进行技术创新, 最终建立专业化团队。

公司高度重视产品质量与安全, 并通过 ISO9001 体系认证, 严格按照国家 GB/4706.8-2008 安全标准和欧洲 CE 安全标准生产, 部分标准已超过欧盟安全标准。公司集研发生产销售一体化, 拥有完整、科学的质量管理体系。

The company was founded in Shenzhen in 2013. Since its establishment, the company has been committed to a healthy lifestyle and has intelligently produced more high-quality health

care products Becoming a trusted manufacturer and brand for consumers. Our company specializes in massage therapy, personal care instruments, EMS massage machines, and airbag massage machines Friction products, graphene heating products, peripheral electronic products for heating protectors, etc. And it has nearly ten participating companies and wholly-owned subsidiaries.

The company always adheres to the 12 word concept of innovation, quality, service, conservation, dedication, and gratitude. Absorb new ideas, strictly control quality and provide comprehensive service tracking, and adhere to producing high-quality products. We have accumulated and developed a wealth, strengthened team cooperation, and trained and introduced high-end talents Putting people first, encouraging employees to innovate in technology, and ultimately establishing a professional team.

The company attaches great importance to product quality and safety, and has passed the ISO9001 system certification. It strictly follows the national GB/4706.8-2008 safety standards and the European CE safety standards for production, and some standards have exceeded the EU safety standards. The company integrates research and development, production, and sales, and has a complete system. A scientific quality management system.

**主要展品 /Products**

膝盖按摩器、腿部按摩器、腰部按摩器、眼部按摩器

Knee massager, Leg massager, Waist massager, Eye Massager

**airdeer  
九霄鹿****九霄鹿****W5-5C85****airdeer**

地址: 浙江省杭州市滨江区聚工路 1 号 2 栋 403 (310051)

Add: Room 403, Building 2, No. 1, Jugong Road, Binjiang District, Hangzhou City, Zhejiang Province, China

电话 /Tel: 0571-86691142

传真 /Fax: 0571-86691143

网址 /Web: https://www.jiuxiaolu.com/

九霄鹿是专业生产自动打包换袋智能感应垃圾桶的生产厂家。

九霄鹿智能感应垃圾桶是杭州祺来电子有限公司旗下的首款智能小家电产品, 产品关键自动打包、自动换袋的功能, 解决了家居生活中, 对垃圾处理中打包垃圾袋以及换袋的琐碎问题。

Airdeer is a manufacturer specializing in the production of automatic bag-changing intelligent sensor trash cans. Airdeer Intelligent Induction Trash Can is the first smart small household appliance product under Hangzhou Qilai Electronics Co., Ltd.

The key function of the product is automatic packaging and automatic bag replacement, which solves the problem of packaging garbage bags and bag replacement in garbage disposal in household life. Trivial question.

**主要展品 /Products**

九霄鹿自动垃圾桶 A1

九霄鹿软包装垃圾袋

Airdeer Self Sealing Smart Trash Can

Airdeer Refill Bag Ring





### 苏州瑞禾信息科技有限公司

SUZHOU RUHE INFORMATION TECHNOLOGY CO.,LTD.

W1-1C91

地址: 江苏省苏州市吴江区中山南路 568 号 26 栋

Add: Building 26, No. 568 Zhongshan South Road, Wujiang District, Suzhou City,

Jiangsu Province

电话 /Tel: 0512-63337176

苏州瑞禾信息科技有限公司成立于 2018 年, 位于美丽的苏州吴江区太湖新城。公司致力于酒店画框艺术屏(画屏、电子相框)酒店智能音箱的研发、生产、销售为一体的公司, 产品主要应用于智慧校园文化展示, 智慧酒店客房, 智慧酒店宴会厅, 企业会议, 家庭客厅, 商超广告, 画院美术馆, 开创智慧文化信息展示新典范, 一画一境界, 一屏一世界。

公司主要客户有: 中国移动, 中国联通, 中央美院, 苏州画院美术馆、京版芳草教育(北京) 科技有限公司, 北京蓓泽教育科技有限公司, 武汉儒家文化传播有限公司、维也纳酒店、锦江集团、希尔顿、全季、华住、丽呈、紫橙网新、大华、海康、宇视、惠科、文香等。

公司自主品牌 UniterHUB 主要面向自有项目渠道客户, “孔雀 PEACOCK” 品牌主要面向 3C 产品, 公司可承接各类非标定制画框艺术屏、智能多媒体音箱产品, 可为客户承接 OEM 和 ODM 订单。

创意: 打造艺术视觉呈现

追求: 赋予作品灵魂和生命

精神: 精益求精每一个细节

Suzhou Ruihe Information Technology Co., Ltd., founded in 2018, is located in the beautiful the Taihu Lake New Town, Wujiang District, Suzhou. The company is committed to the research and development, production, and sales of intelligent speakers for hotel picture frame art screens (picture screens, electronic photo frames). The products are mainly applied to the display of smart campus culture, smart hotel rooms, smart hotel banquet halls, corporate meetings, family living rooms, commercial supermarkets, art galleries, and art galleries, creating a new model of smart cultural information display, with one painting, one realm, and one screen, one world. The main clients of the company include China Mobile, China Unicom, Central Academy of Fine Arts, Suzhou Academy of Fine Arts, Beijing Edition Fangcao Education (Beijing) Technology Co., Ltd., Beijing Beize Education Technology Co., Ltd., Wuhan Confucian Culture Communication Co., Ltd., Vienna Hotel, Jinjiang Group, Hilton, All Seasons, Huazhu, Licheng, Zicheng Wangxin, Dahua, Haikang, Yushi, Huike, Wenxiang, etc. The company's independent brand UniterHUB mainly targets its own project channel customers, while the "Peacock PEACOCK" brand mainly targets 3C products. The company can undertake various non-standard customized frame art screens, intelligent multimedia speaker products, and OEM and ODM orders for customers. Creativity: Creating artwork Visual presentation Pursuit: Giving the work soul and spirit of life: Striving for excellence in every detail

#### 主要展品 /Products

电子产品: 音箱、画屏

Electronic products: speakers, picture screens



JEOLINK

### 东莞市精联精密技术有限公司

Dongguan Jeolink Precision Technology Co.,Ltd

W1-1C94

地址: 广东省东莞市高埗镇塘厦村创富路 9 号

Add: No.9 building, Chuangfu Street, Tangxia District, Gaobu, GD, China

电话 /Tel: 0769-23073669

网址 /Web: www.jeolink.com

东莞市精联精密技术有限公司创立于 2016 年, 是精密五金件、传动部件以及紧固件的专业生产厂家, 公司生产基地位于东莞市高埗镇, 紧靠 G94 高速出口, 交通便利, 厂房面积 11000 多平方米, 现有职工 200 多人。在苏州恒润国际设有办事处, 主要服务于长三角客户。

目前我司拥有 100 多台日本 Star 车铣复合机、CNC 加工中心, 齿轮生产设备以及台湾自动车床, 200 多台进口螺丝设备, 月产能已达到 6 亿粒以上。专业生产机加定制件、蜗杆、齿轮、螺母、螺柱、贴片螺母、电机轴、转轴及非标准各类型紧固件、铜螺丝、碳钢螺丝及不锈钢螺丝产品主要配套于运动器材、通信、新能源汽车, 电子电器、智能安防、仪器仪表、网络设备、智能家居、医疗器械等行业, 并配备全套质量检测设备。公司秉承以质量求发展之理念, 全面落实品质管理, 保证为客户提供最优质的产品。

自公司成立以来, 公司先后通过 ISO9001、ISO14000 及 IATF16949 管理体系及知识产权认证, 并拥有多项专利, 实用新型及软件著作权。相关产品通过 CE, FCC, RoHS 等检测认证, 公司已和多家知名公司开展合作, 并获得良好的声誉。

Dongguan Jeo-link Precision Technology Co., Ltd. was founded in 2016. is a professional manufacturer of precision hardware, transmission parts and fasteners. Our factory is located in Gaobu Town, Dongguan City, close to the G94 expressway exit, with convenient transportation and a plant area of more than 11,000 square meters. We have more than 200 stuffs and we has office in Suzhou.

At present, our company has more than 100 sets of Japanese made Star Swiss-type turning machine, high precision CNC milling machines and gear hobbing equipment, more than 200 sets of custome designed precision screw machines. The monthly production capacity has reached more than 600 million pieces currently. We focused on high precision worms, gears, motors shafts, CNC milling parts, and all kinds of screws and bnuts. Our products are mainly used in sports equipment, communications, electronic vehicals, electronic appliances, intelligent security, instrumentation, network equipment, Smart home, medical equipment and other industries. We have full sets of quality testing equipment such as 3DM, gear measurement center, optical inspaection machine and so on.

The company hvae ISO9001, ISO14000 and IATF16949 management system certification, and related products have passed CE, FCC, RoHS and other testing certifications. We have cooperated with many leading companies and He had a very good reputation in the industry.

#### 主要展品 /Products

专业生产机加定制件、蜗杆、齿轮、螺母、螺柱、贴片螺母、电机轴、转轴及非标准各类型紧固件、铜螺丝、碳钢螺丝及不锈钢螺丝产品主要配套于运动器材、通信、新能源汽车, 电子电器、智能安防、仪器仪表、网络设备、智能家居、医疗器械等行业

We focused on high precision worms, gears, motors shafts, CNC milling parts, and all kinds of screws and bnuts. Our products are mainly used in sports equipment, communications, electronic vehicals, electronic appliances, intelligent security, instrumentation, network equipment, Smart home, medical equipment and other industries.



**东莞劲佳精密部件有限公司**  
**Dongguan Jinjia Precision Parts Co., Ltd**

**W1-1C95**

地址: 广东省东莞市高埗镇塘厦村创富路 9 号

Add: No.9 building, Chuangfu Street, Tangxia District, Gaobu, GD, China

电话 /Tel: 0769-22694759

网址 /Web: www.chinajinjia.com

东莞劲佳精密部件有限公司创立于 2002 年, 是紧固件及五金零部件的专业生产厂家, 公司生产基地位于东莞市高步镇, 紧靠 G94 高速出口, 交通便利, 厂房面积 11000 多平方米, 现有职工 160 多人。

目前我司拥有 200 多台螺丝设备, 60 多台湾名阳自动车床及 30 台日本 STAR 车铣复合机, 月产能已达到 5 亿粒以上, 专业生产标准及非标准各类型紧固件, 铜螺丝, 碳钢螺丝及不锈钢螺丝、车削螺母、螺柱、贴片螺母及非标零部件, 产品主要配套于运动器材、通信、电子电器, 智能安防、仪器仪表、网络设备、智能家居、医疗器械、光伏储能及新能源汽车等行业。

Dongguan Jinjia Precision Parts Co., Ltd. was founded in 2002 and is a professional manufacturer of fasteners and hardware components. The company's production base is located in Gaobu Town, Dongguan City, close to the G94 Expressway exit, with convenient transportation. The factory covers an area of over 11000 square meters and currently employs more than 160 people. At present, our company has over 200 screw equipment, over 60 Taiwan Mingyang automatic lathes, and 30 Japan STAR turning and milling composite machines. Our monthly production capacity has reached over 500 million pieces, specializing in the production of standard and non-standard fasteners of various types, copper screws, carbon steel screws and stainless steel screws, turning nuts, studs, SMD nuts, and non-standard components. Our products are mainly used in sports equipment, communication, electronic appliances, intelligent security, instruments, and network equipment Industries such as smart homes, medical devices, photovoltaic energy storage, and new energy vehicles

**主要展品 /Products**

专业生产标准及非标准各类型紧固件, 铜螺丝, 碳钢螺丝及不锈钢螺丝、车削螺母、螺柱、贴片螺母及非标零部件

Professional production of standard and non-standard fasteners of various types, including copper screws, carbon steel screws and stainless steel screws, turning nuts, studs, SMD nuts, and non-standard components

AWE2023  
艾普兰颁奖典礼

AWE AWARD CEREMONY



2023艾普兰奖  
AWE AWARD

2023.4.29 | 中国·上海  
SHANGHAI · CHINA

智科技 创未来

SMARTIZE THE FUTURE

AWE  
AWARD  
2023